





Weatherproof Metallic Covers

Two-Gang Device Covers

	CAT. NO.	DESCRIPTION
	2CCD	Device Mount
	2CCD-L	Device Mount with Lock Option
	WR281-CBR	Cover, Self-Closing Lids
	WR281-C-WH	Cover, Self-Closing Lids

Two-GFCI Receptacle Cover		
	CAT. NO.	DESCRIPTION
	2CCG	Device Mount

One Duplex and One GFCI Receptacle Cover		
	CAT. NO.	DESCRIPTION
	2CCDG	Device Mount

Two-Single Receptacle Cover — 1.485" Diameter Opening		
	CAT. NO.	DESCRIPTION
	2CCS	Device Mount
	2CCS-L	Device Mount with Lock Option

One Single Receptacle and One Duplex Receptacle Cover — 1.485" Diameter Opening		
	CAT. NO.	DESCRIPTION
	2CCSD	Device Mount

Single Receptacle and One GFCI Receptacle Cover — 1.485" Diameter Opening		
	CAT. NO.	DESCRIPTION
	2CCSG	Device Mount
	2CCSG-L	Device Mount with Lock Option
	WR74-81-C	Cover, Self-Closing Lids, Opening Diameter



Double Switch Cover		
	CAT. NO.	DESCRIPTION
	2CCT	Cover Only, Packed with Spacers
	2CCT-1	Cover with Two Single-Pole 15A, 125V Switches and Spacers

Switch and One Duplex Receptacle Cover		
	CAT. NO.	DESCRIPTION
	2CCTD	Cover Only, Packed with Spacers
	2CCTD-1	Cover with One Switch Single-Pole 15A, 125V and One Duplex Receptacle and Spacers

Switch and One GFCI Receptacle Cover		
	CAT. NO.	DESCRIPTION
	2CCTG	Device Mount Cover Only with Spacers

Note: Raintight when used with appropriate Red•Dot® boxes.
All covers packed with gasket and screws.

Blank Covers

	CAT. NO.	COLOR	DESCRIPTION
	Single-Gang		
	CCB	Silver	Device Mount
	CCB-FS	Silver	Box Mount
	D-PAK®		
	DCCB	Silver	Device Mount
DCCB-BR	Bronze	Device Mount	
DCCB-WH	White	Device Mount	
	Two-Gang		
	2CCB	Silver	Device Mount
	2CCB-FS	Silver	Box Mount
	D-PAK®		
D2CCB	Silver	Device Mount	
	Three-Gang		
	3CCB	Silver	Box Mount

Note: Raintight when used with appropriate Red•Dot® boxes.
All covers packed with gasket and screws.

Weatherproof Metallic Covers

Single-Gang Covers

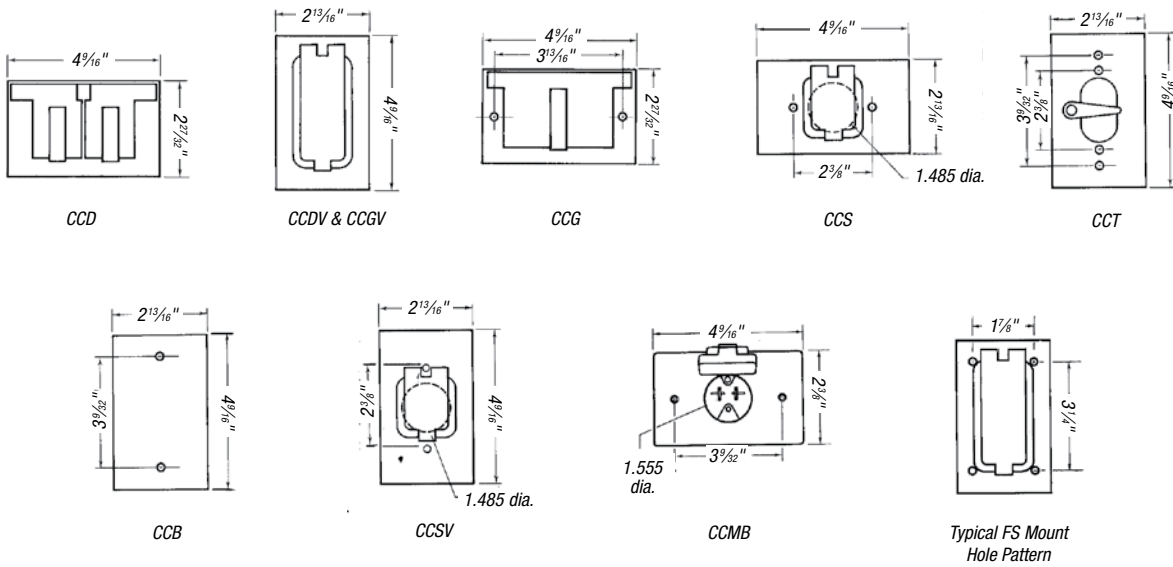

Two- and Three-Gang Covers

