

THE TEMPERATURE SETPOINT CONTROLLER



MODEL TSC INSTRUCTION MANUAL

INTRODUCTION

The Temperature Setpoint Controller Unit (TSC) is a multi-purpose series of industrial control products that are field-programmable for solving various applications. This series of products is built around the concept that the end user has the capability to program different personalities and functions into the unit in order to adapt to different indication and control requirements.

The TSC unit, which you have purchased, has the same high quality workmanship and advanced technological capabilities that have made Red Lion Controls the leader in today's industrial market.

Red Lion Controls has a complete line of industrial indication and control equipment, and we look forward to servicing you now and in the future.



CAUTION: Read complete instructions prior to installation and operation of the unit.



CAUTION: Risk of electric shock.

Table of Contents

GENERAL DESCRIPTION	6
Safety Summary	7
INSTALLATION & CONNECTIONS	7
Installation Environment	7
Standard Unit Installation	7
NEMA 4X/IP65 Unit Installation	7
Unit Removal Procedure	9
Removing Bezel Assembly	9
Installing Bezel Assembly	9
Output Modules	10
Output Variations Without RS-485 Option	10
Output Variations With RS-485 Option	10
Installing Output Modules	10
Output Module “Output On” State	10
Typical Connections	10
Select Input Sensor Type	11
Select AC Power (115/230 VAC)	12
EMC Installation Guidelines	12
Wiring Connections	12
Signal Wiring	13
User Input Wiring	13
AC Power Wiring	13
FRONT PANEL DESCRIPTION	14
Button Functions	14
OPERATION OVERVIEW	15
Controller Power-up	15
Controller Power Down	15
Process Start-up	15
Manual (user) & Automatic Operation	15
Profile Operating Modes	16
Run Mode	16
Off Mode	16

Pause Mode	16
Delay Mode	17
Controlling A Profile	18
Profile Start Operation	18
Start Operation From The Profile Control Status Display	18
Start Operation From The Hidden Mode	18
Start Operation Using The User Input	18
Start Operation On Power-Up	18
Start Operation Via The RS-485 Serial Option	18
Profile Stop Operation	19
Stop Operation From The Profile Control Status Display	19
Stop Operation From The Hidden Mode	19
Stop Operation On Power-Up	19
Stop Operation Via The RS-485 Serial Option	19
Profile Advance Operation	19
Advance Operation From The Profile Control Status Display	19
Advance Operation From The Hidden Mode	20
Advance Operation Via The RS-485 Serial Option	20
Profile Pause Operation	20
Pause Operation From The Profile Control Status Display	20
Pause Operation From The Hidden Mode	20
Pause Operation Using The User Input	20
Pause Operation Via The RS-485 Serial Option	20
Profile Continue Operation	20
Continue Operation From The Profile Control Status Display	20
Continue Operation From The Hidden Mode	21
Continue Operation Using The User Input	21
Continue Operation Via The RS-485 Serial Option	21
Reset Event Outputs Operation	21
Reset Timed Event Output(s) From The Hidden Mode	21
Reset A Timed Event Output Using The User Input	21
Reset A Timed Event Output Via RS-485 Serial Option	21
Configuration Of Parameters	22
Parameter Entry	23

Normal Display Mode	23
Modifying A Secondary Display Parameter From The Front Panel	23
Setpoint Value Display	23
% Output Power Display	24
Profile Control Status Display	24
Profile Phase Time Remaining Display	24
UNPROTECTED PARAMETER MODE	25
Unprotected Parameter Mode Reference Table	25
PROTECTED PARAMETER MODE	26
Protected Parameter Mode Reference Table	26
Front Panel Program Disable	27
HIDDEN FUNCTION MODE	28
Hidden Function Mode Reference Table	28
CONFIGURATION PARAMETER MODULES	29
Input Module (1- IN)	29
Input Type (type)	29
Temperature Scale (SCAL)	29
Temperature Resolution (dCPt)	29
Input Signal Filter (FLtr)	29
Input Sensor Correction Constants (SPAN & SHFt)	30
Setpoint Limit Values (SPLO & SPHI)	30
Auto Setpoint Ramp Rate (SPrP)	30
User Input (InPt)	31
Output Module (2-OP)	32
Time Proportioning Cycle Time (CYCt)	32
Output Control Action (OPAC)	32
Output Power Limits (OPLO & OPHI)	32
Sensor Fail Preset Power (OPFL)	32
ON/OFF Control Hysteresis Band (CHYS)	32
Auto-Tune Damping Code (tcod)	33
Linear DC Analog Output (ANAS, ANLO, & ANHI) (Optional)	33
Lockouts Module (3-LC)	34
Lower Display Lockouts (SP, OP, P-cs, P-tr, UdSP)	34
Protected Mode Lockouts (Code, PID, & AL)	34

Hidden Mode Lockouts (ALrS, CPAC, PrAC, trnF, & tUNE)	34
Alarm Module (4-AL) (Optional)	35
Alarm Action (Act1, Act2)	35
Alarm Reset (rSt1, rSt2)	38
Alarm Standby Delay (Stb1, Stb2)	38
Alarm Value (AL-1, AL-2)	38
Alarm Hysteresis (AHYS)	39
Cooling Output Parameters Module (5-02) (Optional)	39
Cooling Cycle Time (CYC2)	39
Cooling Relative Gain (GAN2)	39
Heat-Cool Overlap/Deadband (db-2)	40
Serial Communications Module (6-SC) (Optional)	41
Baud Rate (bAUd)	41
Parity Bit (PARb)	41
Address Number (Addr)	41
Abbreviated or Full Transmission (Abrv)	41
Print Rate (PrAt)	41
Print Options (PoPt)	41
Control Points Module (7-CP)	42
Control Point Set-up (CSEt)	42
Setpoint Value (SP-n)	42
PID Values(PId)	42
Profiles Module (8-Pr)	42
Profile Set-Up	42
Profile Cycle Count (PnCC)	43
Profile Linking (PnLn)	43
Profile Power Cycle Status (PnSt)	44
Profile Error Band (PnEb)	44
Ramp Phase (Pnrr)	44
Setpoint Value (PnLn)	45
Hold Phase (PnHn)	45
Timed Event Output(s) (Pn 1 to Pn 16)	45
Profile Example	47
Factory Service Operations Module (9-FS)	48

RS-485 SERIAL COMMUNICATIONS INTERFACE	58
Communication Format	58
Sending Commands And Data	58
Receiving Data	60
Serial Connections	62
Terminal Descriptions	62
Connecting To A Host Terminal	63
Troubleshooting Serial Communications	63
PID CONTROL	64
Proportional Band	64
Integral Time	64
Derivative Time	65
Output Power Offset (Manual Reset)	65
Pid Adjustments	65
ON/OFF CONTROL	67
AUTO-TUNE	69
To Initiate Auto-Tune:	70
To Cancel Auto-Tune: (Old PID settings remain in effect).	70
APPENDIX "A" - APPLICATION EXAMPLE	71
APPENDIX "B" - SPECIFICATIONS AND DIMENSIONS	72
APPENDIX "C" - TROUBLESHOOTING	76
Output Leakage Current	79
APPENDIX "D" - MANUAL TUNING	80
APPENDIX "E" - CALIBRATION	82
APPENDIX "F" - USER PARAMETER VALUE CHART	85
APPENDIX "G" - ORDERING INFORMATION	87

GENERAL DESCRIPTION

The TSC is a setpoint controller suitable for time vs. temperature, process control applications. The TSC accepts signals from a variety of temperature sensors (thermocouple and RTD elements), precisely displays the process temperature, and provides an accurate output control signal (*time proportional or linear*) to maintain a process at the desired control point. A comprehensive set of easy to use steps allows the controller to solve various application requirements. The user input can be programmed to perform a variety of controller functions.

Dual 4-digit displays allow viewing of the measured temperature value and setpoint or temperature and profile status simultaneously. Front panel indicators inform the operator of controller status and output states. Replaceable output modules (Relay, Logic/SSR drive or Triac) can be fitted to the main control output, alarm output(s) or timed event output(s), and cooling output.

The TSC has been designed to simplify the set-up and operation of a controlled setpoint profile program. The setpoint program is easily entered and controlled through the front panel. Full display capabilities keep the operator informed of the process temperature, profile status, output states, and setpoint value.

The controller can operate in the standard PID control mode for both heating or cooling, with on-demand Auto-Tune which establishes the PID gain set. The PID gain set can be fine tuned by the operator at any time or may be locked from further modification. The unit can be transferred to the manual control mode providing the operator with direct control of the output.

The TSC features four programs or profile recipes, each with up to eight ramp/soak segments, which can be easily stored and executed at any time. Longer profiles can be achieved by linking one or more profiles together, creating a single profile of up to 32 ramp/soak segments. Temperature profile conformity is assured during either soak (hold) phases or both ramp and hold phases by an adjustable error band parameter. The program repeat function cycles the profile either a set number of times or continuously. Power-on options automatically re-start, stop, or resume a running profile. The profile can be controlled via the front panel buttons, the user input, or the serial communications option.

Four control points, each having a setpoint and PID parameter set, are available for instant front panel implementation during batch changeover, or other process conditions. A control point may have its PID gain set values disabled when implementing the control point.

The optional RS-485 multidrop serial communications interface provides the capability of two-way communication between a TSC unit and other compatible equipment such as a printer, a programmable controller, or a host computer. In multipoint applications the address number of each unit on the line can be programmed from 0-99. Up to thirty two units can be installed on a single pair of wires. The Setpoint value, % Output Power, Setpoint Ramp Rate, etc. can be interrogated or changed, by sending the proper command code via serial communications. Alarm output(s) may also be reset via the serial communications interface option.

Optional alarm output(s) may be configured to operate as a timed event output or as a standard alarm output. As an alarm output it may be configured to activate according to a variety of actions (Absolute HI or LO, Deviation HI or LO, or Band IN or OUT) with adjustable hysteresis. Also, a standby feature suppresses the output(s) on power-up until the temperature stabilizes outside the alarm region. Timed event output(s) allow the controller to activate other equipment while a profile is running. Each profile can define up to 16 event states (phases), for each output(s).

An optional secondary output is available for processes that require cooling, which provides increased control accuracy and response.

The optional linear 4-20 mA or 0 to 10 VDC output signal is available to interface with final actuators, chart recorders, indicators, or other controllers. The output signal can be digitally scaled and selected to transmit one of the following:

% Output Power	Measurement Value Deviation
Measurement Value	Setpoint Value

An optional NEMA 4X/IP65 rated bezel is available for washdown and/or dirty environments, when properly installed. Modern surface-mount technology, extensive testing, plus high immunity to noise interference, makes the controller extremely reliable in industrial environments.

SAFETY SUMMARY

All safety related regulations, local codes and instructions that appear in the manual or on equipment must be observed to ensure personal safety and to prevent damage to either the instrument or equipment connected to it. If equipment is used in a manner not specified by the manufacturer, the protection provided by the equipment may be impaired.

Do not use the TSC to directly command motors, valves, or other actuators not equipped with safeguards. To do so, can be potentially harmful to persons or equipment in the event of a fault to the unit. An independent and redundant temperature limit indicator with alarm outputs is strongly recommended. Red Lion Controls model IMT (thermocouple) or model IMR (RTD) units may be used for this purpose. The indicators should have input sensors and AC power feeds independent from other equipment.

INSTALLATION & CONNECTIONS

INSTALLATION ENVIRONMENT

The unit should be installed in a location that does not exceed the maximum operating temperature and provides good air circulation. Placing the unit near devices that generate excessive heat should be avoided.

Continuous exposure to direct sunlight may accelerate the aging process of the bezel. The bezel should be cleaned only with a soft cloth and neutral soap product. Do NOT use solvents.

Do not use tools of any kind (screwdrivers, pens, pencils, etc.) To operate the keypad of the unit.

STANDARD UNIT INSTALLATION

Prepare the panel cutout to the dimensions shown in the installation figure. Remove the panel latch and cardboard sleeve from the unit and discard the cardboard sleeve. The unit should be installed with the bezel assembly in place. Insert the unit into the panel cutout. While holding the front of the unit in place, push the panel latch over the rear of the unit so that the tabs of the panel latch engage in the slots on the case. The panel latch should be engaged in the farthest forward slots possible. Tighten the screws evenly until the unit is snug in the panel.

NEMA 4X/IP65 UNIT INSTALLATION

The optional NEMA 4X/IP65 TSC Controller is designed to provide a watertight seal in panels with a minimum thickness of 1/8 inch. The unit meets NEMA 4X/IP65 requirements for indoor use, when properly installed. The units are intended to be mounted into an enclosed panel. Prepare the panel cutout to the dimensions shown in the installation figure. Carefully apply the adhesive side of the panel gasket to the panel cutout. Remove the panel latch and cardboard sleeve from the unit and discard the cardboard sleeve. The unit should be installed with the bezel assembly in place and the bezel screws tightened slightly. Insert the unit into the panel cutout. While holding the front of the unit in place, push the panel latch over the rear of the unit so that the tabs of the panel latch engage in the slots on the case. The panel latch should be engaged in the farthest forward slot possible. To achieve a proper seal, tighten the latch screws evenly until the unit is snug in the panel (torque to approximately 7 in-lbs [79 N-cm]). Do NOT over-tighten the screws.

PANEL INSTALLATION & REMOVAL

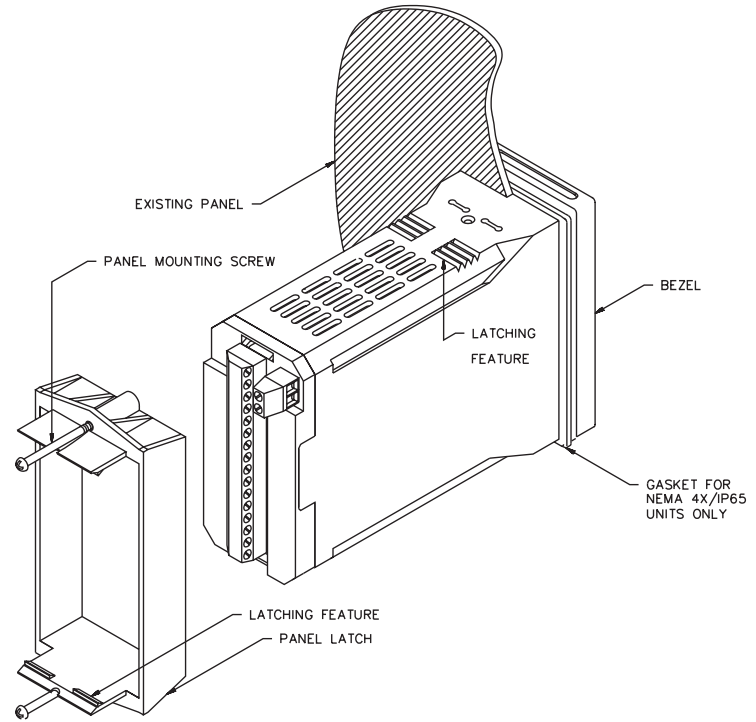
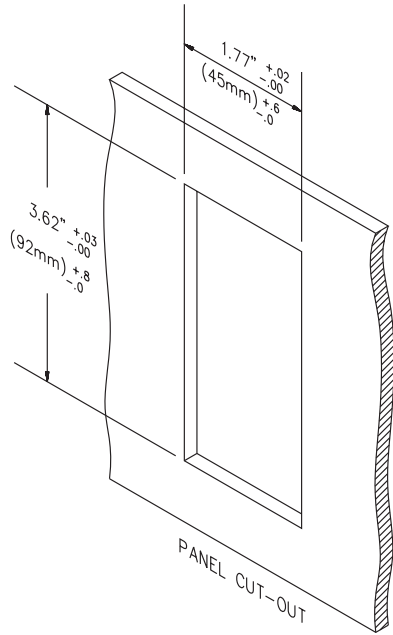

Note: The installation location of the controller is important. Be sure to keep it away from heat sources (ovens, furnaces, etc.), away from direct contact with caustic vapors, oils, steam, or any other process by-products in which exposure may effect proper operation.

Note: Prior to applying power to the controller, the internal AC power selector switch must be set. Damage to the controller may occur if the switch is set incorrectly.

UNIT REMOVAL PROCEDURE

To remove a NEMA 4X/IP65 or standard unit from the panel, first unscrew and remove the panel latch screws. Insert flat blade screwdrivers between the latch and the case on the top and bottom of the unit so that the latches disengage from the grooves in the case. Push the unit through the panel from the rear.

REMOVING BEZEL ASSEMBLY

The bezel assembly must be removed from the case to install or replace output modules, to select the input sensor type, or to set the 115/230 VAC selector switch. To remove a standard bezel assembly (without bezel securing screws) press the latch under the lower bezel lip and withdraw the bezel assembly. To remove the sealed NEMA 4X/IP65 bezel assembly, loosen the two bezel securing screws until a slight “click” is felt (the screws are retained in the bezel) and withdraw the assembly. It is recommended to disconnect power to the unit and to the output control circuits to eliminate the potential shock hazard with the bezel assembly removed.

Note: The bezel assembly contains electronic circuits which are damaged by static electricity. Before removing the assembly, discharge stray static electricity on your body by touching an earth ground point. It is also important that the bezel assembly be handled only by the bezel itself. Additionally, if it is necessary to handle a circuit board, be certain that hands are free from dirt, oil, etc., to avoid circuit contamination which may lead to malfunction.

INSTALLING BEZEL ASSEMBLY

To install the standard bezel assembly, insert the assembly into the case until the bezel latch snaps into position.

To install the NEMA 4X/IP65 bezel assembly, insert the assembly into the case and tighten the bezel screws uniformly until the bezel contacts the case and then turn each screw another half turn to insure a watertight seal (do not over-tighten screws).

Note: When substituting or replacing a bezel assembly, be certain that it is done with the same model using the same Output Modules. Damage to the controller may result if the unit's output modules are not the same. A NEMA 4X/IP65 and a standard bezel assembly are NOT interchangeable.

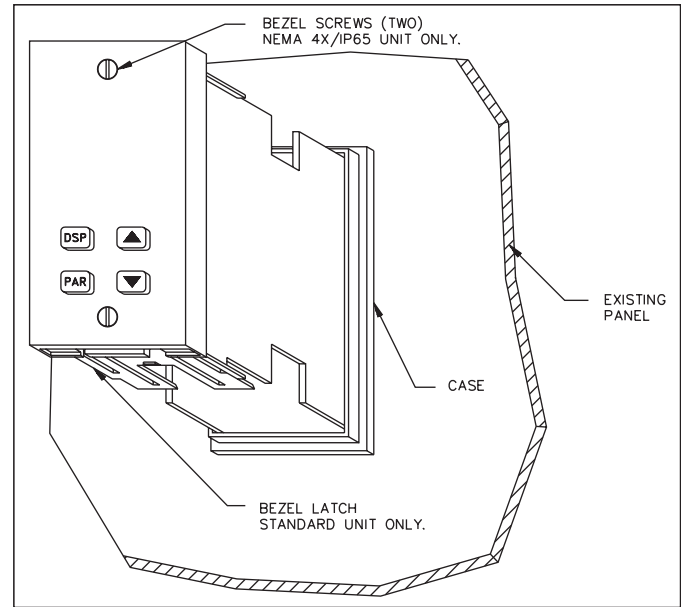

OUTPUT MODULES

The main control, optional alarm, and optional cooling output sockets must be fitted with the appropriate output module. Output modules are shipped separately and must be installed by the user.

Output Variations Without RS-485 Option

The Dual Alarm or the Cooling with Alarm output, without the RS-485 option, has independent outputs. Therefore, the cooling output and/or alarm output(s) can be installed with any combination of output modules.

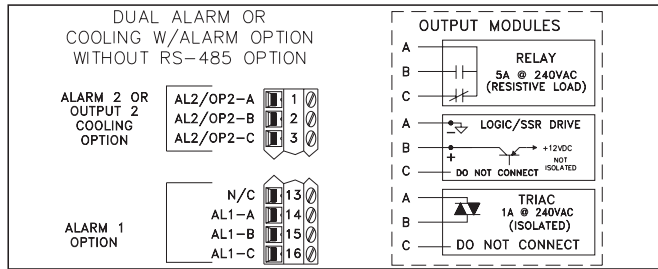

Output Variations With RS-485 Option

The Dual Alarm or the Cooling with Alarm output, with RS-485 option, does not have independent outputs. In this case, the cooling output and/or alarm output(s) must have the same type of output modules installed since they share the common terminal.

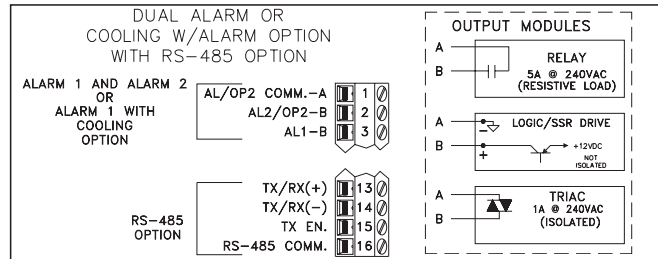

Installing Output Modules

To install an output module into the controller, remove the bezel assembly from the case (see Removing Bezel Assembly). Locate the correct output module socket (OP1, AL1, or AL2/OP2, see hardware figure or label outside of case) and plug the output module into the socket. No re-programming is required. If changing an output module type, be sure the appropriate output interface wiring changes are made. Re-install the bezel assembly when complete.

OUTPUT MODULE "OUTPUT ON" STATE

Relay	Normally open contact is closed.
Logic/SSR Drive	Source is active.
Triac	Solid state switch is closed.

Typical Connections

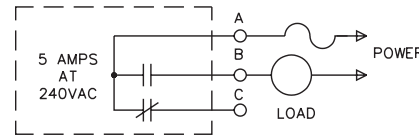

Relay:

Type: Form-C

Rating: 5 Amps @ 120/240 VAC or 28 VDC (resistive load), 1/8 HP @ 120 VAC (inductive load).

Life Expectancy: 100,000 cycles at maximum load rating. (Decreasing load and/or increasing cycle time, increases life expectancy.)

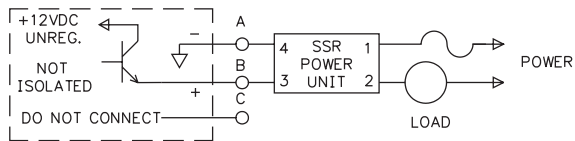

Logic/SSR Drive:

Type: Non-isolated switched DC, 12 VDC typ. (internal 500 Ω resistance).

Drive: 10 mA max. (400 ohm external load).

Drives up to three SSR Power Units.

Protection: Short-circuit protected.

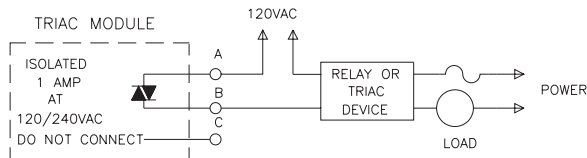

Triac:

Type: Isolated, Zero Crossing Detection.

Rating:

Voltage: 120/240 VAC.

Max. Load Current: 1 Amp @ 35°C

0.75 Amp @ 50°C

Min. Load Current: 10 mA

Off State Leakage Current: 7 mA max.

Operating Frequency: 20 to 500 Hz.

Protection: Internal Transient Snubber, Fused.

LOGIC/SSR
DRIVE
MODULE

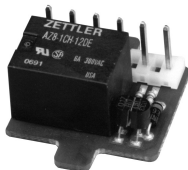
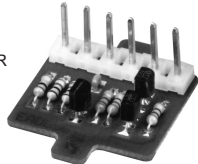

RELAY
MODULE

SELECT INPUT SENSOR TYPE

The input sensor type (thermocouple or RTD) must be selected by an internal hardware jumper to match the input sensor type programmed. The jumper is located inside the case on a small accessory circuit board near the rear of the unit on the main circuit board (See hardware selection figure and/or label on outside of case).

HARDWARE FIGURE

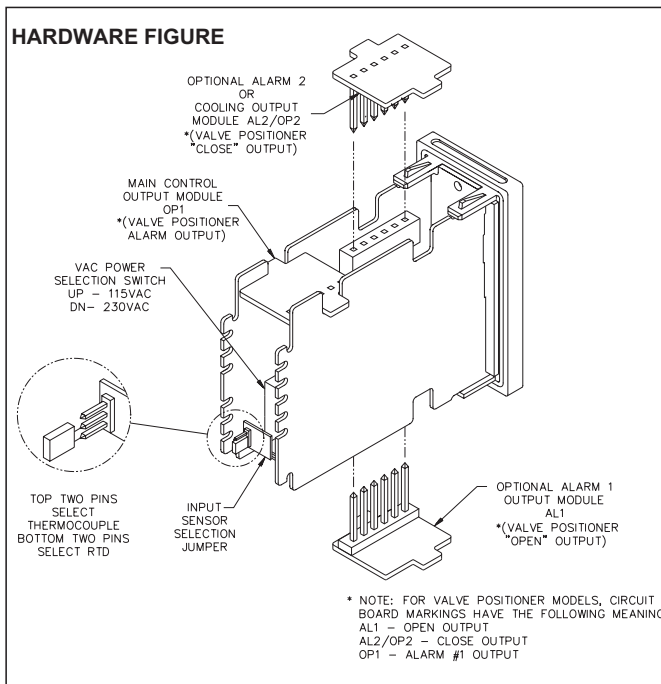

SELECT AC POWER (115/230 VAC)

The AC power to the unit must be selected for either 115 VAC or 230 VAC. The selector switch is located inside the case near the rear of the unit on the main circuit board (See hardware figure and/or label on inside or outside of case). The unit is shipped from the factory with the switch in the 230 VAC position.

Note: Damage to the controller may occur if the AC selector switch is set incorrectly.

EMC INSTALLATION GUIDELINES

Although this unit is designed with a high degree of immunity to ElectroMagnetic Interference (EMI), proper installation and wiring methods must be followed to ensure compatibility in each application. The type of electrical noise, source or coupling method into the unit may be different for various installations. Listed below are some EMC guidelines for successful installation in an industrial environment.

1. The unit should be mounted in a metal enclosure, which is properly connected to protective earth.
2. Use shielded (screened) cables for all Signal and Control inputs. The shield (screen) pigtail connection should be made as short as possible. The connection point for the shield depends somewhat upon the application. Listed below are the recommended methods of connecting the shield, in order of their effectiveness.
 - a. Connect the shield only at the panel where the unit is mounted to earth ground (protective earth).
 - b. Connect the shield to earth ground at both ends of the cable, usually when the noise source frequency is above 1 MHz.
 - c. Connect the shield to common of the unit and leave the other end of the shield unconnected and insulated from earth ground.
3. Never run Signal or Control cables in the same conduit or raceway with AC power lines, conductors feeding motors, solenoids, SCR controls, and heaters, etc. The cables should be run in metal conduit that is properly grounded. This is especially useful in applications where cable runs are long and portable two-way radios are used in close proximity or if the installation is near a commercial radio transmitter.
4. Signal or Control cables within an enclosure should be routed as far away as possible from contactors, control relays, transformers, and other noisy components.

5. In extremely high EMI environments, the use of external EMI suppression devices, such as ferrite suppression cores, is effective. Install them on Signal and Control cables as close to the unit as possible. Loop the cable through the core several times or use multiple cores on each cable for additional protection. Install line filters on the power input cable to the unit to suppress power line interference. Install them near the power entry point of the enclosure. The following EMI suppression devices (or equivalent) are recommended:

Ferrite Suppression Cores for signal and control cables:

Fair-Rite # 0443167251 (RLC #FCOR0000)

TDK # ZCAT3035-1330A

Steward #28B2029-0A0

Line Filters for input power cables:

Schaffner # FN610-1/07 (RLC #LFIL0000)

Schaffner # FN670-1.8/07

Corcom #1VR3

Note: Reference manufacturer's instructions when installing a line filter.

6. Long cable runs are more susceptible to EMI pickup than short cable runs. Therefore, keep cable runs as short as possible.
7. Switching of inductive loads produces high EMI. Use of snubbers across inductive loads suppresses EMI.

Snubbers:
RLC #SNUB0000

WIRING CONNECTIONS

After the unit has been mechanically mounted, it is ready to be wired. All wiring connections are made on a fixed terminal block. When wiring the unit, use the numbers on the label to identify the position number with the proper function.

All conductors should meet voltage and current ratings for each terminal. Also cabling should conform to appropriate standards of good installation, local codes and regulations. It is recommended that power supplied to the unit (AC or DC) be protected by a fuse or circuit breaker. Strip the wire leaving approximately 1/4" (6 mm) bare wire exposed (stranded wires should be tinned with solder). Insert the wire into the terminal and tighten the screw until the wire is clamped in tightly. Each terminal can accept up to two, 18-gage wires. Wire each terminal block in this manner.

Signal Wiring

When connecting the thermocouple or RTD leads, be certain that the connections are clean and tight. If the thermocouple probe cannot be connected directly to the controller, thermocouple wire or thermocouple extension-grade wire must be used to extend the connection points (copper wire will not work). Always refer to the thermocouple manufacturer's recommendations for mounting, temperature range, shielding, etc. For multi-probe temperature averaging applications, two or more thermocouple probes may be connected to the controller (always use the same type). Paralleling a single thermocouple to more than one controller is NOT recommended. Generally, the red wire from the thermocouple is negative and connected to the controller's common.

RTD sensors are used where a higher degree of accuracy and stability is required when compared to thermocouples. Most RTD sensors available are the three wire type. The third wire is a sense lead for canceling the effects of lead resistance of the probe. Four wire RTD elements may be used by leaving one of the sense leads disconnected.

Two wire RTD sensors may be used in either of two ways:

- A) Install a shorting wire between terminals #8 & #9. A temperature offset error of 2.5°C/ohm of lead resistance will exist. The error may be compensated for by programming a temperature offset.
- B) Install a copper sense wire of the same wire gage as the RTD leads. Attach one end of the wire at the probe and the other end to terminal #8. Complete lead wire compensation will be in effect. (preferred method)

Note: With extended cable runs, be sure the lead resistance is less than 10 ohms/lead.

User Input Wiring

The programmed User Input function is performed when terminal #7 is used in conjunction with common (terminal #10). Any form of mechanical switch may be connected to terminal #7. Sinking open collector logic with less than 0.7 V saturation may also be used (no pull-up resistance is necessary).

Note: Do not tie the commons of multiple units to a single switch. Use either a multiple pole switch for ganged operation or a single switch for each unit.

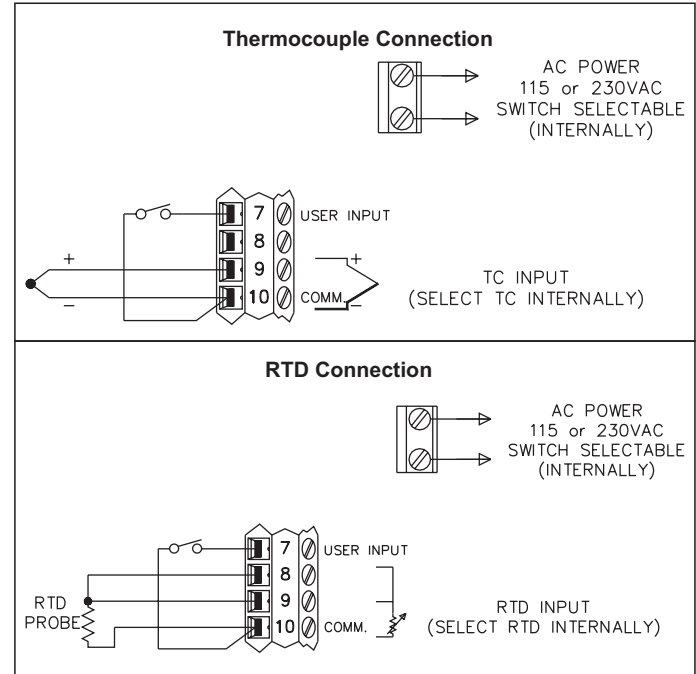

AC Power Wiring

Primary AC power is connected to the separate two position terminal block labeled AC. To reduce the chance of noise spikes entering the AC line and affecting the controller, a separate AC feed should be used to power the controller. Be certain that the AC power to the controller is relatively "clean" and within the -15%, +10% variation limit. Connecting power from heavily loaded circuits or circuits that also power loads that cycle on and off, (contacts, relays, motors, etc.) should be avoided.

FRONT PANEL DESCRIPTION

The front panel bezel material is flame and scratch resistant tinted plastic. Available is an optional NEMA 4X/IP65 version which has a bezel that meets NEMA 4X/IP65 requirements, when properly installed. There are two 4-digit LED displays, a red upper Main Display and a lower green Secondary Display.

There are up to six annunciators depending on options installed, with red backlighting, which illuminate to inform the operator of the controller and output status.

Four front panel buttons are used to access different modes and parameters. The following is a description of each button.

BUTTON FUNCTIONS

DSP - In the normal operating mode, the Display (DSP) button is used to select one of the four parameters in the secondary display or indicate the temperature unit's (°F or °C). In the Configuration Parameter Modes, pressing this button causes the unit to exit (escape) to the normal operating mode with NO changes made to the selected parameter.

UP, DN - In the normal operating mode, the up/dn buttons can be used to modify the setpoint value, % output power (manual mode only), the profile status, or the profile phase time remaining, when viewed in the secondary display. The variables for each parameter are selected using the up/dn buttons. In the Hidden Mode, the up/dn buttons can be used to reset alarm(s), event output(s), select auto or manual operation, invoke or cancel auto-tune, load a control point, or change the status of a running profile.

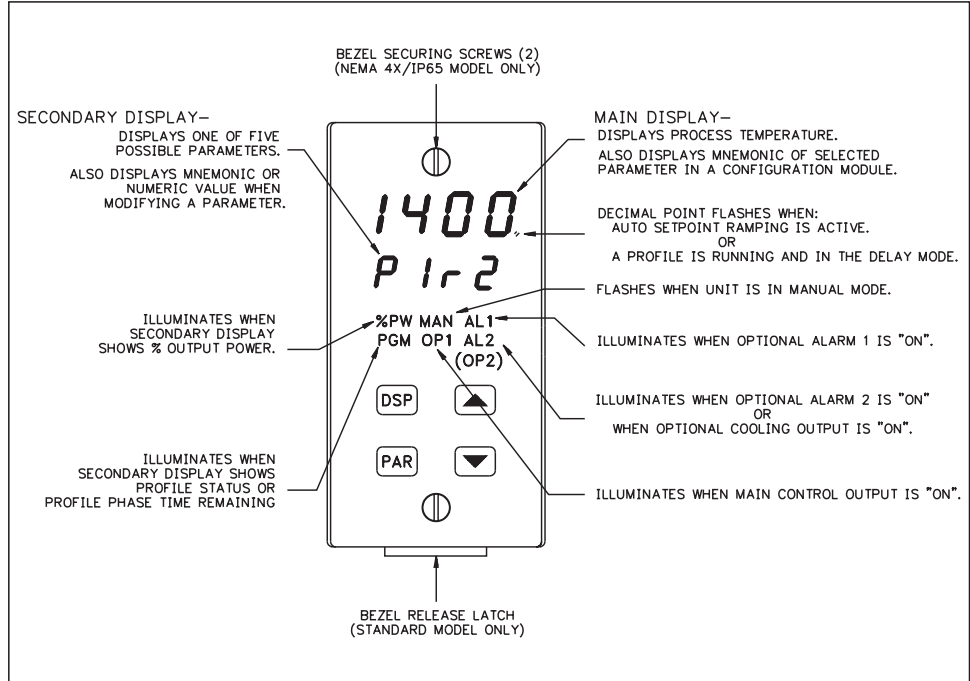

PAR - The Parameter (PAR) button is used to access, enter, and scroll through the available parameters in any mode.

OPERATION OVERVIEW

CONTROLLER POWER-UP

Upon applying power, the controller delays control action and temperature indication for five seconds to perform several self-diagnostic tests and displays basic controller information. Initially, the controller illuminates both displays and all annunciators to verify that all display elements are functioning. Following, the controller displays the programmed input sensor type in the Main display (verify that the input select sensor jumper matches the programming). Concurrently, it displays the current revision number of the operating system software in the bottom display. The controller checks for correct internal operation and displays an error message (E-XX) if an internal fault is detected (see Troubleshooting).

A profile can be programmed to Start (run mode), Stop (off mode), or Pause if it was running on power-up (see “Profile Power Cycle Status Parameter” section).

Upon completion of this sequence, the controller begins control action by displaying the temperature and updating the outputs based upon the PID control value.

CONTROLLER POWER DOWN

At power down, the steady state control value as well as all parameters and control modes are saved, to provide a quick and predictable temperature response on the next power-up.

When powering down the process, it is important to power down the controller at the same time. This prevents the reset action of the controller from shifting the proportional band while the temperature is dropping, which prevents excessive overshoot on the next process start-up.

PROCESS START-UP

After starting the process, the controller’s PID settings must be initially “tuned” to the process for optimum temperature control. Tuning consists of adjusting the Proportional Band, Integral Time, and Derivative Time parameters to achieve the optimum response to a process disturbance. Once the controller is tuned, it may need to be re-tuned if the process has been changed significantly. Several options exist for tuning these parameters:

- A) Use the controller’s built-in Auto-Tune feature (see Auto-Tune).
- B) Use a manual tuning technique (see manual tuning).

C) Use a third party tuning software package (generally expensive and not always precise).

D) Use values based on control loop experience or values from a similar process.

If the controller is a replacement, the PID settings from the unit being replaced may be used as good initial values. Be sure to consider any differences in the units and the PID settings when replacing. The PID settings may be fine tuned by using the techniques outlined in the PID Control section. After tuning the controller to the process, it is important to power the load and the controller at the same time for best start-up response.

MANUAL (USER) & AUTOMATIC OPERATION

The controller can be transferred between Automatic control (closed loop; PID or ON/OFF control) and Manual control (open loop). Placing the controller in the Manual Mode does not impede the advancement or operation of a running profile. In the Hidden Function Mode, the “trnf” parameter allows the operator to select the desired operating mode. To allow front panel switching between control modes, program the transfer (trnf) parameter to “Enbl” in the Lockout module. The User Input or RS-485 serial interface option may also be used to perform the auto/manual transfer function, independent of the setting in the Lockout module.

Manual operation provides direct control of the output(s) from 0 to +100%, or -100% to +100% if cooling output is installed. The MAN (manual) annunciator flashes to indicate that the unit is in manual operation.

In the Manual Mode, the output power can be adjusted using the front panel arrow buttons when % output power is viewed in the lower display. If the % output power is locked or read only, then the output power can be adjusted in the unprotected parameter mode when OP is viewed. With the serial option, the % output power can be modified independent of what is viewed in the display as long as the unit is in the manual mode.

When transferring the controller mode from/to automatic, the control power output(s) remain constant, exercising true “bumpless” transfer. When transferring from manual to automatic, the power initially remains steady but integral action will correct (if necessary) the closed loop power demand at a rate proportional to the Integral Time. The programmable high and low power limit values are ignored when the unit is in manual operation.

PROFILE OPERATING MODES

Run Mode

The controller is in the Run Mode when a profile is executing. While in the Run Mode, the profile can be stopped (Off Mode), paused (Pause Mode) or advanced to the next phase. A profile is started and placed into the Run Mode either manually or automatically when the controller is powered-up. The advancement of the profile can be viewed in the secondary display.

Off Mode

The Off Mode signifies that all profiles are dormant. The Off Mode is achieved by manually terminating a profile in progress or by allowing a profile to run to completion. When a profile ends or is terminated, the active setpoint is the last hold setpoint value. A profile terminated during a ramp phase results in the active setpoint value to be the setpoint value at the instant of termination. A profile terminated during a hold phase results in the active setpoint value to be the setpoint value at the hold level.

Pause Mode

The pause mode signifies that a profile is active but the time base is stopped. The pause mode is caused only by a manual action. Pausing a profile during a ramp phase stops the ramp and the controller maintains the setpoint value at the instant of the pause action. During hold phases, the timing of the hold phase is stopped. The use of pause mode effectively lengthens the total run time of a profile. Pause mode is indicated by “PAUS” flashing in the profile control status display. A profile can be placed in the pause mode via the front panel buttons, the user input, or the serial communications option. The unit remains in the pause mode until a continue operation is performed. The continue operation places the profile into the run mode.

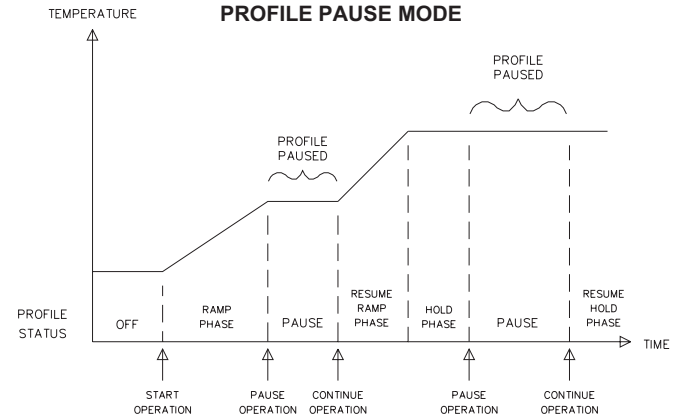

Delay Mode

The Delay Mode signifies that a profile is active but the time base, or profile advancement is stopped. This is caused by automatic action of the controller when the input temperature deviates more than a specified amount from the profile setpoint. The Delay Mode is similar to the pause mode, except the delay mode is invoked automatically by the controller.

The Profile Deviation Error Band programmed for a positive value, allows the Delay Mode to be invoked only during hold phases. A negative value allows the delay mode to be invoked during “both” ramp and hold phases. The profile automatically resumes when the process temperature is within the prescribed error band value. The Delay Mode is indicated by “dEly” flashing in the profile control status display and by a flashing decimal point in the upper main display. The Delay Mode can be terminated manually by changing the deviation error band value to a larger value or to zero for off. The new error band value takes effect immediately.

PROFILE DELAY MODE

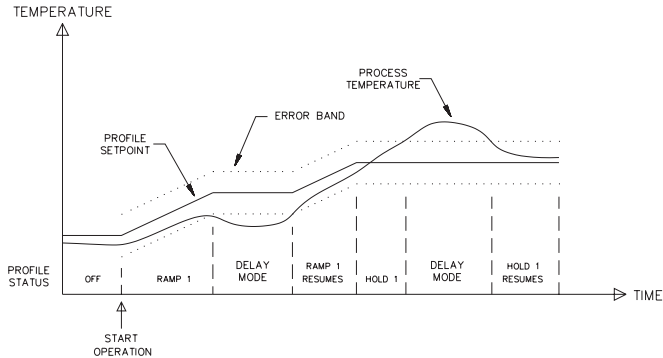

CONTROLLING A PROFILE

Profile Start Operation

A profile always starts at the first ramp phase and the setpoint value ramps from the current temperature value. The profile can be programmed to ramp from a known setpoint value (see Ramp Phase section). Link-started profiles use the last target setpoint level as the starting point. A profile is started from the off mode, which places the controller into the run mode. To re-start a running profile from the beginning, it is necessary to first stop the profile.

Start Operation From The Profile Control Status Display

1. Verify the profile control status display (P-CS) is enabled in lockout programming.
2. Profile must be in the off mode (no profiles running).
3. Press and hold “up” button for three seconds until “Pr-1” appears.
4. Select the desired profile by using the “up/down” buttons.
5. Press the “PAR” button to start the selected profile. The unit displays “Strt” in the secondary display and starts the profile. If the “PAR” button is not pressed within five seconds, no action is taken.

Start Operation From The Hidden Mode

1. Verify profile access (PrAC) in the hidden mode is enabled in lockout programming.
2. Profile must be in the off mode (no profiles running).
3. Press and hold the “PAR” button for three seconds to enter the hidden mode.
4. Scroll to “Prun” (if necessary) by pressing the “PAR” button.
5. When “Prun” is displayed, use the “up/down” buttons to select the desired profile (Pr-1, Pr-2, Pr-3, or Pr-4).
6. Press the “PAR” button to start the selected profile. The unit displays “End” in the secondary display and starts the profile. If a selection is not made within ten seconds, no action is taken.

Start Operation Using The User Input

The user input can only start profile #1.

User Input Selected For Run/Stop (P1rS):

A low to high transition at terminal # 7 always starts profile 1.

User Input Selected For Run/Pause (P1rH):

A low to high transition at terminal # 7 starts profile 1, if no profiles are in the pause mode.

Note: Refer to input module 1, user input section, for more details.

Start Operation On Power-Up

If power is interrupted or removed from the unit, the profile can be programmed to automatically start when power is restored. In the Setpoint Profiles Module (8-Pr), a profile can be programmed to automatically re-start on power-up. The “Strt” option must be selected for each profile (see power cycle status parameter for details).

Start Operation Via The RS-485 Serial Option

Any profile can be started via the serial communications option. Transmit the unit address, command letter with the value identifier and the desired profile number via the serial port (see serial communication section for details).

Shown below is a typical command string.

Start profile 2 of TSC unit 6.

N6CU2*

Profile Stop Operation

Stopping a profile places the controller into the off mode.

When a profile is stopped, the active setpoint value is the old profile setpoint value.

Stop Operation From The Profile Control Status Display

1. Verify the profile control status display (P-CS) is enabled in lockout programming.
2. Press and hold the “up/down” buttons simultaneously for three seconds.
3. “OFF” appears in the secondary display and the profile is placed in the off mode.

Stop Operation From The Hidden Mode

1. Verify profile access (PrAC) in the hidden mode is enabled in lockout programming.
2. Press and hold the “PAR” button for three seconds to enter the hidden mode.
3. Scroll to “Prun” (if necessary) by pressing the “PAR” button.
4. When “Prun” is displayed, use the “up/down” buttons to select stop (off).
5. Press the “PAR” button to stop the profile. The unit displays “End” in the secondary display and stops the profile. If a selection is not made within ten seconds, no action is taken.

Stop Operation On Power-Up

If power is interrupted or removed to the unit, the profile can be programmed to automatically stop when power is restored. In the Setpoint Profiles Module (8-Pr), each profile must be selected for the “Stop” option (see power cycle status parameter for details).

Stop Operation Via The RS-485 Serial Option

A running profile can be stopped via the serial communications option. Transmit the unit address, command letter, with the value identifier and number via the serial port (see serial communication section for details).

Shown below is a typical command string.

Stop the currently running profile of TSC unit 6.

N6CU5*

Profile Advance Operation

Advancing a profile ends the currently active phase and begins the next phase of the profile. The total run time of the profile is shortened by using the advance operation. Profiles in the pause mode must have a continue operation performed before an advance operation. The profile can be advanced from the delay mode.

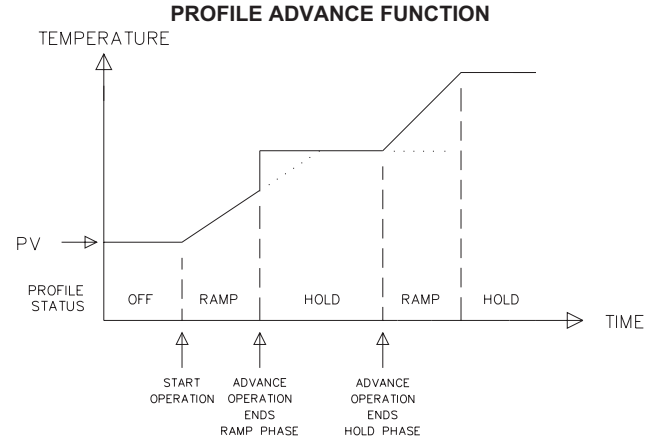

Advance Operation From The Profile Control Status Display

1. Verify the profile control status display (P-CS) is enabled in lockout programming.
2. Press and hold the “up” button for three seconds.
3. “Adnc” appears in the secondary display and the profile advances to the next phase.

Advance Operation From The Hidden Mode

1. Verify profile access (PrAC) in the hidden mode is enabled in lockout programming.
2. Press and hold the “PAR” button for three seconds to enter the hidden mode.
3. Scroll to “Prun” (if necessary) by pressing the “PAR” button.
4. When “Prun” is displayed, use the “up/down” buttons to select advance (Adnc).
5. Press the “PAR” button to advance the profile to the next phase.
6. The unit displays “End” in the secondary display and the profile advances to the next phase. If a selection is not made within ten seconds, no action is taken.

Advance Operation Via The RS-485 Serial Option

A running profile can be advanced to the next phase via the serial communications option. Transmit the unit address, command letter, the value identifier and number via the serial port (see serial communication section for details).

Shown below is a typical command string.

Advance the currently running profile of TSC unit 6 to the next phase.
N6CU8*

Profile Pause Operation

The pause mode freezes the state of the profile. The controller maintains the setpoint value at the instant the profile is placed into the pause mode. The profile must have a continue operation performed to resume the profile operation.

Pause Operation From The Profile Control Status Display

1. Verify the profile control status display (P-CS) is enabled in lockout programming.
2. Press and hold the “down” button for three seconds.
3. “PAUS” appears in the secondary display and the profile is placed in the pause mode.

Pause Operation From The Hidden Mode

1. Verify profile access (PrAC) in the hidden mode is enabled in lockout programming.
2. Press and hold the “PAR” button for three seconds to enter the hidden mode.
3. Scroll to “Prun” (if necessary) by pressing the “PAR” button.

4. When “Prun” is displayed, use the “up/down” buttons to select pause (PAUS).
5. Press the “PAR” button to pause the profile.
6. The unit displays “End” in the secondary display and the profile is paused. If a selection is not made within ten seconds, no action is taken.

Pause Operation Using The User Input

The user input can pause a running profile.

User Input Selected For Run/Pause (P1rH):

A low level at terminal # 7 pauses a profile that is running.

Note: Refer to input module 1, user input section, for more details.

Pause Operation Via The RS-485 Serial Option

A profile can be paused via the serial communications option. Transmit the unit address, command letter, with the value identifier and number via the serial port (see serial communication section for details).

Shown below is a typical command string.

Pause the currently running profile of TSC unit 6.
N6CU6*

Profile Continue Operation

The continue operation resumes operation of a profile that is in the pause mode. The continue operation places the profile back into the run mode. The profile resumes normal execution from the point where it was paused.

Continue Operation From The Profile Control Status Display

1. Verify the profile control status display (P-CS) is enabled in lockout programming.
2. Profile must be in the pause mode.
3. Press and hold the “up” button for three seconds.
4. “Cont” appears in the secondary display and the profile is placed into the run mode.

Continue Operation From The Hidden Mode

1. Verify profile access (PrAC) in the hidden mode is enabled in lockout programming.
2. Unit must be in the pause mode.
3. Press and hold the “PAR” button for three seconds to enter the hidden mode.
4. Scroll to “Prun” (if necessary) by pressing the “PAR” button.
5. When “Prun” is displayed, use the “up/down” buttons to select continue (Cont).
6. Press the “PAR” button to continue the profile.
7. The unit displays “End” in the secondary display and the profile resumes to run. If a selection is not made within ten seconds, no action is taken.

Continue Operation Using The User Input

The user input can continue a paused profile.

User Input Selected For Run/Pause (P1rH):

A high level continues the profile.

Note: Refer to input module 1, user input section, for more details.

Continue Operation Via The RS-485 Serial Option

A paused profile can be continued via the serial communications option. Transmit the unit address, command letter, with the value identifier and number via the serial port (see serial communication section, for details).

Shown below is a typical command string.

Continue profile 2 of TSC unit 6.
N6CU7*

Reset Event Outputs Operation

The Timed Event Output(s) may be manually reset to the “Off” state at any time during profile execution. Once reset, the outputs remain reset until the profile advances to the next phase and updates the event output states.

Reset Timed Event Output(s) From The Hidden Mode

1. Verify alarm access (ALrS) in the hidden mode is enabled in lockout programming.
2. Press and hold the “PAR” button for three seconds to enter the hidden mode.
3. Scroll to “ALrS” (if necessary) by pressing the “PAR” button.
4. Press the “up” button to reset event output 1. Press the “down” button to reset event output 2. An event output remains reset during phase transitions if the buttons are held.
5. The “up” or “down” button must be pressed within ten seconds to reset an event output. If an output is not reset within ten seconds, no action is taken.

Reset A Timed Event Output Using The User Input

The user input can reset the timed event outputs.

Note: The reset operation via the user input resets “Both” AL1 and AL2, independent of their operation as an alarm or event output.

User Input Selected For Alarm Reset (ALrS):

A low level resets the timed event outputs. As long as the input is held low, the output(s) remain reset.

Note: Refer to input module 1, user input section, for more details.

Reset A Timed Event Output Via RS-485 Serial Option

A timed event output can be reset via the serial communications option. Transmit the unit address, command letter, with the value identifier via the serial port (see serial communication section, for details).

Shown below is a typical command string.

Reset timed event output 2 of TSC unit 6.
N6RH*

CONFIGURATION OF PARAMETERS

As supplied from the factory, the controller parameters have been programmed to the values listed in the Quick Reference Tables. The user must modify the values, if necessary, to suit the application.

Operation and configuration of the controller is divided into five distinct operational/programming modes to simplify the operation of the controller: Normal Display Mode, Unprotected Parameter Mode, Protected Parameter Mode, Configuration Parameter Modules, Hidden Function Mode, and Configuration Parameter Modules.

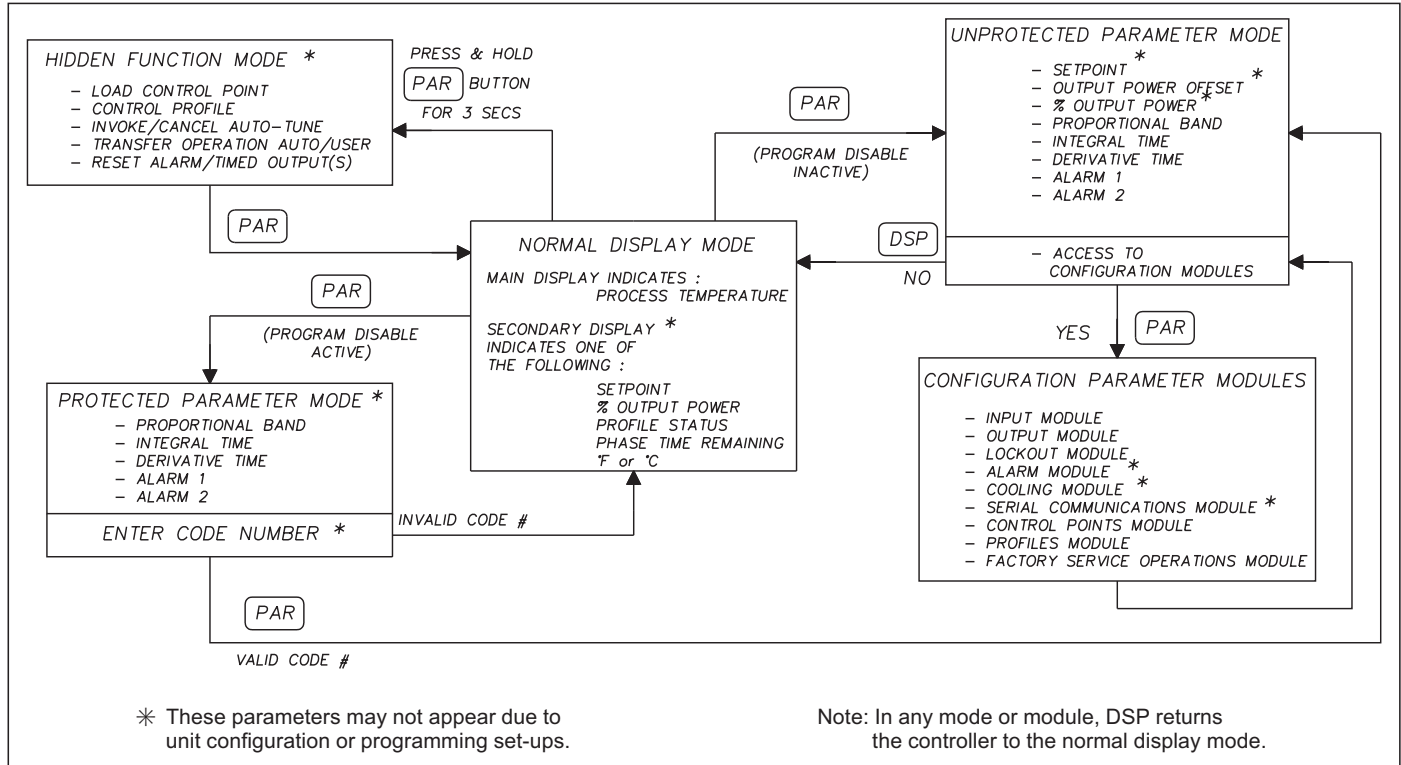

PARAMETER ENTRY

The PAR button is used to select the desired parameter. To modify the parameter setting use the UP and DOWN buttons, and then press PAR to enter the new value, the controller progresses to the next parameter. In a Configuration Parameter Module, pressing the DSP button causes the new value to be rejected, the controller displays “End”, and returns to the Normal Display Mode. For those parameters outside the Configuration Parameter Modules, the new value takes effect and is committed into controller memory WHILE the value is keyed in. The following is a list of these commonly modified parameters:

- Setpoint
- Output Power
- Output Power Offset
- Proportional Band
- Integral Time
- Derivative Time
- Alarm 1 Value
- Alarm 2 Value

Note: While in a Configuration Parameter Module, all new parameters are rejected and the old ones recalled if power is lost to the controller. If power is removed while modifying ANY parameter, be certain to check the parameter for the proper value.

NORMAL DISPLAY MODE

In the normal display mode, the process temperature is always displayed in the main display. By successively pressing the DSP button, one of five parameters can be viewed in the secondary display:

- Temperature Setpoint
- % Output Power
- Profile Control Status
- Profile Phase Time Remaining
- Display Temperature Units (°F or °C).

Each of these displays can be independently locked out from appearing or from being modified by the user (see parameter lockout section).

Modifying A Secondary Display Parameter From The Front Panel

The controller must be in the normal display mode to modify any of the secondary display parameters. Temperature units symbol indicates the temperature scale (°F or °C) and cannot be modified from this mode. The other four parameters can be modified when viewed in the secondary display (if not locked). Pressing the DSP button scrolls through the secondary display parameters. The following describes how these parameters can be modified when viewed in secondary display.

Setpoint Value Display

Use the up and down arrow buttons to modify the setpoint value when viewed (if not locked). If locked, the setpoint can be changed in the unprotected or protected mode when “SP” is viewed, independent of viewing in the secondary display. The setpoint value is constrained to the programmable setpoint limit values (SPLO & SPHI, input module 1).

The profile setpoint value can be changed during profile operation to effect immediate changes to the profile. If locked, the target setpoint value can be changed when viewed in the protected mode. Permanent changes to the profile setpoint value must be done in the profiles module (8-Pr). Changing the setpoint value may cause the profile to enter the delay mode if the error band parameter is enabled.

The ramping setpoint value is displayed during ramp phases. Immediate changes made to the ramping setpoint value do not alter the ramp rate, but change the ramp time remaining to the next target setpoint level. This action either lengthens or shortens the total time remaining. The phase time remaining is effected the instant the setpoint value is changed.

The holding setpoint value is displayed during hold phases. A change to the holding setpoint value causes the controller to immediately operate at the new setpoint level. In addition, the next ramp phase begins ramping from the modified setpoint value to the target setpoint value.

% Output Power Display

The % output power can only be changed when the unit is in the manual mode. The annunciator %PW lights when viewed, then use the up and down arrow buttons to modify the % output power (if not locked). If locked, the % output power can be changed in the unprotected or protected mode when “OP” is viewed, independent of viewing in the secondary display. The % output power is not constrained to the programmable output power limit values (OPLO & OPHI, output module 2).

Profile Control Status Display

The annunciator PGM lights when either the profile control status or the phase time remaining is displayed. The profile control status indicates the current mode of a profile. The table shows various displays for profile modes.

Profile Status Display	Description
OFF	Profile is off. No profiles running.
P1r1	Profile #1 is running and in ramp phase #1.
P2H8	Profile #2 is running and in hold phase #8.
P3r4	Profile #3 is running and in ramp phase #4.
PAUS	Profile is Paused (PAUS flashes). Currently running profile is in the pause mode.
dEly	Profile is Delayed (dEly flashes). Currently running profile is in the delay mode.

The front panel buttons allow the operator to change the profile status. The operation of a profile is controlled directly from the profile control status display, if not locked (see controlling a profile section for details).

Profile Phase Time Remaining Display

The annunciator PGM lights when either the phase time remaining or the profile control status is viewed. Use the up/down front panel buttons to change the time remaining, if not locked. The ramp or hold phase time remaining can be changed during profile operation to effect immediate changes to the profile. Permanent changes to the profile must be done in the profiles module (8-Pr).

During ramp phases the display indicates the time remaining until the next hold phase. If the time remaining is changed during a ramp phase, the controller calculates a new, but temporary, ramp rate. The setpoint ramps at the new ramp rate value to the next setpoint level. The new ramp rate may be at a faster or slower rate depending on the direction that the time remaining was changed. Changing the time remaining value to zero causes an immediate advance to the next hold phase, unless the profile is in the pause mode. In this case, when the profile is placed back into the run mode, the profile immediately advances to the next hold phase.

During hold phases the display indicates time remaining until the next ramp phase. Changes to the time remaining during a hold phase effect the duration of the hold phase. A value of zero causes the profile to advance to the next ramp phase unless the profile is in the pause mode.

Changing the time remaining effects the total run time of the profile. When the profile is in the off mode, “0.0” minutes is displayed in the phase time remaining display.

UNPROTECTED PARAMETER MODE

The Unprotected Parameter Mode is accessed by pressing the PAR button from the normal display mode with program disable inactive. In this mode, the operator has access to the list of the most commonly modified controller parameters. At the end of the list, a configuration “access point” allows the operator to enter the configuration parameter modules. These modules allow access to the fundamental set-up parameters of the controller. When the program list has been scrolled through, the controller displays “End” and returns to the normal display mode. The unit automatically returns to the normal display mode if a button is not pressed within eight seconds.

Unprotected Parameter Mode Reference Table

Display	Parameter	Range and Units (Factory Setting Value)	Description/Comments
SP	Temperature Setpoint	Must be within range of limits SPLO, SPHI 1 or 0.1 degree (0)	Appears only if setpoint value is locked (LOC) or read only (rEd). During a profile ramp phase, indicates the target setpoint value.
OPOF	%Output Power Offset	-99.9% to 100.0% SPLO, SPHI 1 or 0.1 degree (0.0)	Appears only if integral time (Intt) = 0 and controller is in automatic mode.
OP	Output Power	-99.9% to 100.0% SPLO, SPHI 1 or 0.1 degree (0.0)	Appears only if controller is in user (manual) mode and % output power is locked (LOC) or read only (rEd). This parameter is not limited to output power limits (OPL0 & OPHI)
ProP	Proportional Band	0.0 to 999.9% of selected input range (4.0)	0.0% is ON/OFF control. If = 0.0%, set control hysteresis appropriately.
Intt	Integral Time	0 to 9999 sec. (120)	0 is off. This parameter does not appear if proportional band = 0.0%.
dErt	Derivative Time	0 to 9999 sec. (30)	0 is off. This parameter does not appear if proportional band = 0.0%.
AL-1	Alarm 1 Value	-999 to 9999 1 or 0.1 degree (0)	This parameter does not appear if the alarm option is not installed or is configured as a timed event output.
AL-2	Alarm 2 Value	-999 to 9999 1 or 0.1 degree (0)	This parameter does not appear if the alarm option is not installed or is configured as a timed event output. Also does not appear if the cooling option is installed.
CNFP	Configuration Access Point	NO	Return to normal display mode.
		YES	Enter Configuration modules.
		1-IN	Configure input parameters.
		2-OP	Configure output parameters.
		3-LC	Configure parameter lockouts.
		4-AL	Configure alarms (optional)
		5-02	Configure cooling output (optional)
		6-SC	Configure serial communications (optional)
		7-CP	Configure control points
		8-PR	Configure profiles
9-FS	Factory service operations (Qualified technicians only)		
End	Unit returns to normal display mode.	—	Brief display message

PROTECTED PARAMETER MODE

The Protected Parameter Mode is accessed from the normal display mode by pressing the PAR button with program disable active. In this mode, the operator has access to the list of the most commonly modified controller parameters that have been “unlocked” in the configuration parameter lockouts module. Depending on the code number entered in the lockout module, access to the unprotected parameter mode and hence, the configuration parameter modules, is possible. The controller returns to the normal display mode if the unprotected mode and configuration modules cannot be accessed.

Protected Parameter Mode Reference Table

Display	Parameter	Range and Units (Factory Setting Value)	Description/Comments
ProP	Proportional Band	0.0 to 999.9% of selected input range (4.0)	0.0% is ON/OFF control. If = 0.0%, set control hysteresis appropriately. This parameter does not appear if locked (LOC).
Intt	Integral Time	0 to 9999 sec. (120)	0 is off. This parameter does not appear if proportional band = 0.0% or locked (LOC).
dErt	Derivative Time	0 to 9999 sec. (30)	0 is off. This parameter does not appear if proportional band = 0.0% or locked (LOC).
AL-1	Alarm 1 value	-999 to 9999 or 0.1 degree (0)	This parameter does not appear if the alarm option is not installed, locked (LOC), or configured as a timed event output.
AL-2	Alarm 2 value	-999 to 9999 1 or 0.1 degree (0)	This parameter does not appear if the alarm option is not installed, the cooling option is installed, locked (LOC), or configured as a timed event output.
Code	Access code to unprotected mode	0 to 250 (0)	To gain access to unprotected mode, enter the same value for Code as entered in parameter lockouts. This parameter does not appear if zero is entered in code parameter lockout.
End	Unit returns to normal display mode		Brief display message display mode

FRONT PANEL PROGRAM DISABLE

There are several ways to limit operator access to the programming of parameters from the front panel buttons. The settings of the parameters in the parameter lockout module, the code number entered, and the state and/or function of the user input (terminal #7) affect front panel access.

The following chart describes the possible program disable settings.

TERMINAL #7		
User Input Programmed For PLOC	Code Number	Description
Inactive	0	Full access to all modes and parameter modules.
Active	0	Access to protected parameter mode only. Code number will NOT appear.
Active	Any # between 1 & 250	Access to protected parameter mode. Correct programmed code number allows access to unprotected parameter mode and configuration modules.
NOT programmed for PLOC	0	Full access to all modes and parameter modules.
NOT programmed for PLOC	Any # between 1 & 250	Access to protected parameter mode. Correct programmed code number allows access to unprotected parameter mode and configuration modules.

Note: A universal code number 222 can be entered to gain access to the unprotected mode and configuration modules, independent of the programmed code number.

HIDDEN FUNCTION MODE

The Hidden Function Mode is only accessible from the normal display mode by pressing and holding the PAR button for three seconds. In this mode, five controller functions can be performed.

Automatic/Manual Transfer
Initiate/Cancel Auto-tune
Reset Alarm/Timed Event Output(s)
Load Control Point
Control Profile Status

Each function may be “locked out” in the configuration parameter lockouts module. The PAR button is used to scroll to the desired function and the up and down buttons are used to select the operation. Pressing the PAR button while the function is displayed executes the function and returns the unit to the normal display mode. Pressing the DSP button exits this mode with no action taken. The unit automatically returns to the normal display mode if a function is not executed in eight seconds.

Hidden Function Mode Reference Table

Display	Parameter	Range and Units (Factory Setting Value)	Description/Comments
CP	Load Control Point	NO cp-1 cp-2 cp-3 cp-4 (NO)	This step does not appear if locked (LOC). Exits to normal display mode if executed. Select control point to load then press PAR to implement.
PruN	Control profile status	Pr-1 Pr-2 Pr-3 Pr-4 (OFF)	This step does not appear if locked (LOC), or profile is running. Exits to normal display mode if executed. Select profile to start, then press PAR button.
		Adnc Cont PAUS OFF (Cont)	This step does not appear if locked (LOC), or profile is in OFF mode. If profile is running, select control mode, then press PAR button.
trnF	Transfer mode of operation	Auto - Automatic control User - Manual control (Auto)	This step does not appear if locked (LOC). Exits to normal display mode if executed.
IUNE	Auto-Tune invocation	YES/NO (NO)	Yes: starts /restarts auto-tune sequence. No: terminates auto-tune sequence. This step does not appear if locked (LOC) or exits to normal display mode if executed.
ALrS	Reset alarm/timed event output(s)	UP key resets Alarm 1/event output 1 DOWN key resets Alarm 2/event output 2	This step does not appear if alarm option not installed, if locked (LOC) or previous step performed.

CONFIGURATION PARAMETER MODULES

Accessible from the unprotected parameter mode, the configuration parameter modules allow the operator access to the controller's fundamental set-up parameters. There are nine possible configuration stages that can be accessed. At the configuration stage access point "CNFP", the operator uses the UP & DOWN arrow buttons to select the desired configuration parameter module. Press the PAR button to enter the module where the settings can be viewed or modified.

The PAR button is used to scroll through the parameters and the UP and DOWN buttons are used to modify the parameter value. The PAR button enters the desired choice, advancing to the next parameter. The operator can press the DSP button to exit (escape) without modifying the parameter, which returns the unit to the normal display mode. After the parameters in a module are viewed or modified, the unit returns to the configuration access point, allowing access to other modules.

INPUT MODULE (1- IN)

The controller has several input set-up parameters which must be programmed prior to setting any other controller parameters.

Input Type (type)

Select from the list of various thermocouple and RTD sensors. Be sure to set the internal input select jumper to the appropriate position (TC or RTD, see select input sensor type or the label on inside of case for location of jumper).

The following is a list of the possible sensors:

tc-t	-	Type T TC
tc-E	-	Type E TC
tc-J	-	Type J TC
tc-k	-	Type K TC
tc-r	-	Type R TC
tc-S	-	Type S TC
tc-B	-	Type B TC
tc-N	-	Type N TC
LIN	-	Linear mV display
r385	-	385 curve RTD
r392	-	392 curve RTD
rLIN	-	Linear ohms display

Temperature Scale (SCAL)

Select either degrees Fahrenheit (°F) or degrees Celsius (°C). If changed, be sure to check All parameters.

Temperature Resolution (dCPt)

Select either 1 or 0.1 degree resolution. If changed, be sure to check All parameters.

Input Signal Filter (FLtr)

Select the relative degree of input signal filtering. The filter is an adaptive digital filter which discriminates between measurement noise and actual process changes, therefore, the influence on step response time is minimal. If the signal is varying too greatly due to measurement noise, increase the filter value. Additionally, with large derivative times, control action may be too unstable for accurate control. Increase the filter value. Conversely, if the fastest controller response is desired, decrease the filter value.

- 0-minimal
- 1-normal
- 2-increased
- 3-maximum

INPUT MODULE (1- IN) (Cont'd)

Input Sensor Correction Constants (SPAN & SHFt)

If the controller temperature disagrees with a reference temperature instrument or if the temperature sensor has a known calibration, the controller temperature can be compensated by a correction slope (SPAN) and offset (SHFt).

SPAN - 0.001 to 9.999
SHFt - -999 to 9999

The following equation expresses the relationship:

$$\text{Desired Display Temp} = (\text{Controller Temp} \times \text{SPAN}) + \text{SHFt}$$

EX1.) The controller reads 293°F while a reference instrument indicates 300°F. A SHFt value of +7°F corrects the controller indication to match the reference. (Use SPAN = 1.000)

EX2.) A thermocouple probe is calibrated over the region of operation to achieve more accurate temperature control. The calibration results are as follows:

Desired Temperature	Thermocouple Output
400.0F	395.0F
800.0F	804.0F

$$\text{SPAN} = \frac{800\text{F} - 400\text{F}}{804\text{F} - 395\text{F}} = 0.978$$

$$\text{SHFT} = 400\text{F} - (0.978 \times 395\text{F}) = 13.7^\circ\text{F}$$

SPAN value of 0.978 and SHFT value of 13.7°F corrects the indicator to the probe.

Setpoint Limit Values (SPLO & SPHI)

The controller has programmable high and low setpoint limit values to restrict the setting range of the setpoint. Set the limit values so that the temperature setpoint value cannot be set outside the safe operating area of the process.

SPLO - -999 to 9999
SPHI - -999 to 9999

Auto Setpoint Ramp Rate (SPrP)

The setpoint can be programmed to ramp independent of the controller's display resolution. The setpoint ramp rate can reduce thermal shock to the process, reduce temperature overshoot on start-up or setpoint changes, or ramp the process at a controlled rate

SPrP - 0.1 to 999.9 degrees/minute

A ramp value of zero disables setpoint ramping. If the user input is programmed for setpoint ramp, it affects the enabling and disabling of setpoint ramping (refer to user input section). Setpoint ramping is initiated on power-up or when the setpoint value is changed and is indicated by a decimal point flashing in the far right corner of the main display.

Note: The auto setpoint ramp rate is independent from the operation of a profile.

Once the ramping setpoint reaches the target setpoint, the setpoint ramp rate is disengaged until the setpoint is changed again. If the ramp value is changed during ramping, the new ramp rate takes effect. If the setpoint is ramping prior to invoking Auto-Tune, the ramping is suspended during auto-tune and then resumed afterward using the current temperature as a starting value. Deviation and band alarms are relative to the target setpoint, not the ramping setpoint. If the analog output is programmed to transmit the setpoint value, the instantaneous ramping setpoint value is transmitted.

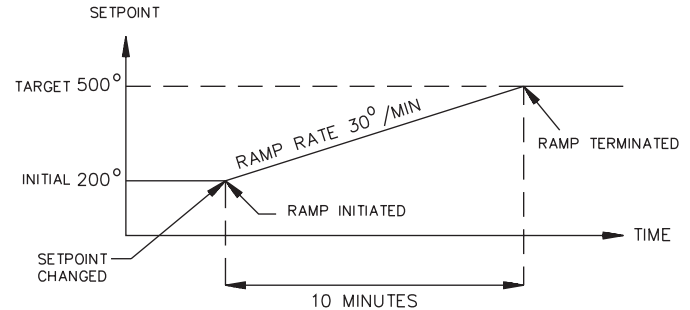

Note: Depending on the ramp rate relative to the process dynamics, the actual process temperature may not track the ramping setpoint value.

User Input (InPt)

The User Input requires the input to be in its active state for 100 msec minimum to perform the function. The unit will execute all functions in 100 msec, except the print request function which requires 110 to 200 msec for a response. A function is performed when the User Input (terminal 7), is used in conjunction with common (terminal 10).

Note: Do not tie the commons of multiple units to a single switch. Either use a multiple pole switch for ganged operation or a single switch for each unit. Transition activated functions do not occur on controller power-up.

Below is a list of the available functions.

PLOC - Program Lock. A low level enables the program disable function which places the unit in the Protected Parameter Mode. A high level disables the program disable function.

Note: Front panel disable is possible without using this program lock function, refer to front panel program disable section.

ILOC - Integral Action Lock. A low level disables the integral action of the PID computation. A high level resumes the integral action.

trnF - Auto/Manual Transfer. A negative transition places the unit in the manual (user) mode and a positive transition places the unit in the automatic operating mode. The output is “bumpless” when transferring to either operating mode.

SPrP - Setpoint Ramp. A low level terminates auto setpoint ramping and the controller operates at the target setpoint. Terminating auto setpoint ramping is the same as setting the ramp rate to zero ($SPrP = 0.0$). A high level enables the auto setpoint ramp rate.

Note: This does not operate with a profile.

ALrS - Alarm/Timed Event Output Reset. If the alarm option is installed, a low level resets the alarm/timed event output(s) to their inactive state as long as the user input is low.

Prnt - Print Request. A low level transmits the print options selected in the serial communications module (6-SC). If the user input is held low, after the printing is complete a second print request is issued.

CP - Control Point Select. A high to low transition loads Control Point 2 into the memory of the controller. The controller now operates with data of Control Point 2. A low to high transition loads Control Point 1 into the memory of the controller. The controller now operates with data of Control Point 1.

Note: Control Point data loaded into memory overwrites the existing data setpoint and optionally the PID gain set. Control Points may be loaded during profile operation.

P1rH - Profile Run/Pause. A low level pauses any running profile. A high level allows a paused profile to resume. A low to high transition starts Profile 1, if no other profile was running.

P1rS - Profile Run/Stop. A low level stops any running profile. A high level allows any profile to run. A low to high transition always starts profile 1.

OUTPUT MODULE (2-OP)

The controller has parameters which affect how the main control output (OP1) responds to temperature changes and sensor failures.

Time Proportioning Cycle Time (CYCt)

The selection of cycle time depends on the time constant of the process and the type of output module used.

CYCt - 0 to 120 seconds

For best control, a cycle time equal to 1/10 of the process time constant is recommended; longer cycle times could degrade temperature control, and shorter cycle times will provide little benefit at the expense of shortened relay life. When using a Triac module or a Logic/SSR drive output module with the SSR Power Unit, a relatively short cycle time may be selected.

A setting of zero keeps the main control output and front panel indicator off. Therefore, if using the analog output for control, the main output and indicator can be disabled.

Output Control Action (OPAC)

For heat and cool applications, the main output (OP1) should be used for heating (reverse acting) and the optional cooling output (OP2) should be used for cooling (direct acting).

OPAC - rEv (Reverse acting)
drct (Direct acting)

If drct (direct acting) is selected, the main output (OP1) is direct acting and the cooling output (OP2) is reverse acting.

Note: When using a relay output module, the control action may also be reversed by using the normally closed contacts.

The linear DC analog output, when assigned to output power (OP) for control purposes, will always follow the controller output power demand. A direct acting linear output signal can be implemented in two ways:

1. Use “direct” for output control action (OPAC).
2. Interchange the two analog output scaling points ANLO & ANHI (see linear DC analog output in the output parameter module section).

Output Power Limits (OPLO & OPHI)

Enter the safe output power limits for the process. These parameters may also be used to limit the minimum and maximum controller power due to process disturbances or setpoint changes to reduce overshoots by limiting the process approach level.

OPLO & OPHI - 0 to 100%

If the cooling option is installed, the limits range from:

OLO & OPHI - -100 to 100%

With the cooling option installed, the Lower Limit can be set to less than 0% to limit maximum cooling or set to greater than 0% to limit minimum heating. Set the High Limit to less than 0% to limit minimum cooling or greater than 0% to limit maximum heating. When controlling power in the manual mode, the output power limits do not take affect.

Sensor Fail Preset Power (OPFL)

If a failed sensor is detected, the control output(s) default to a preset power output.

OPFL - 0% (OP1 output full “off”) to 100% (OP1 output full “on”)

If the cooling option is installed, the range is extended from:

OPFL - -100% to +100%

At 0% both outputs are off, at 100% OP1 is on and OP2 is off, and at -100% OP2 is on and OP1 is off. The alarm outputs always have an up-scale drive (+9999), independent of this setting, for failed sensor.

ON/OFF Control Hysteresis Band (CHYS)

The controller can be placed in the ON/OFF control mode by setting the proportional band to 0.0%. The control hysteresis value affects only the main control output (OP1).

CHYS - 1 to 250 degrees

The hysteresis band should be set to a minimum value to eliminate output chatter at the setpoint. Generally, 2 to 5° is sufficient for this purpose. Set the hysteresis band to a sufficient level prior to invoking Auto-Tune.

Auto-Tune Damping Code (tcod)

Prior to invoking Auto-Tune, the damping code should be set to achieve the desired damping level under PID control. When set to 0, this yields the fastest process response with some overshoot. A setting of 4 yields the slowest response with the least amount of overshoot. Damping codes of 0 or 1 are recommended for most thermal processes.

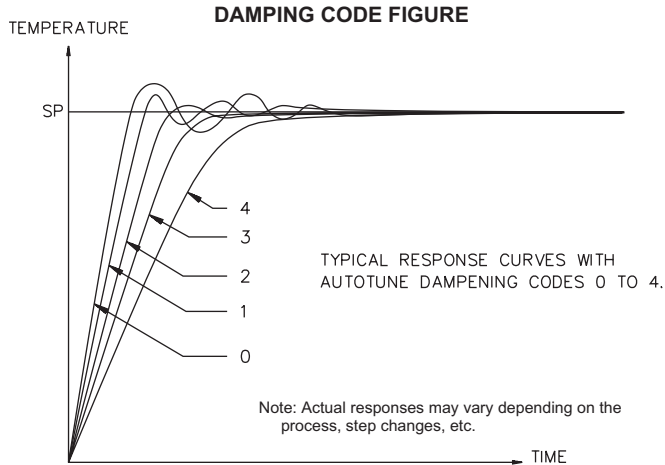

Linear DC Analog Output (ANAS, ANLO, & ANHI) (Optional)

The Linear DC output can be programmed to transmit one of four controller parameters:

ASSIGN DC OUTPUT (ANAS):

- INP - Scaled input process value
- OP - Percent output power
- dEV - Process setpoint deviation
- SP - Process setpoint value

With high and low digital scaling points, the range of the Linear DC output can be set independent of the controller's range.

ANLO (4 mA or 0 VDC) - -999 to 9999

ANHI (20 mA or 10 VDC) - -999 to 9999

This allows interfacing directly with chart recorders, remote indicators, slave controllers, or linear power control units. The output is isolated from input common and located on rear terminals #11 (OUT+) & #12 (OUT-). When using the linear DC analog output for main control by assigning the DC output for percent output power, the front panel indicator OP1 can be disabled by setting the time proportioning cycle time equal to zero. This also disables the main control output, OP1.

If transmitting the setpoint value, (for cascaded control with additional controllers), the controller transmits the instantaneous ramping setpoint, not the target value, when running a profile.

This also applies if the analog output is configured for process setpoint deviation (dEV).

EX1.) Chart Record Process Display Value (0 to 10 VDC):

The process range is 300-700. Programming 300 for ANLO (0 VDC value) and 700 for ANHI (10 VDC value) yields full scale deflection for a chart recorder (0 to 10 VDC). The 0 to 10 VDC output is assigned to transmit the input process (ANAS = INP).

EX2.) Linear Control Output (4 to 20 mA):

A linear DC input power control unit is used for process control. Programming 0.0% for ANLO (4 mA value) and +100.0% for ANHI (20 mA value) configures the output. The 4-20 mA output is assigned to transmit percent output power (ANAS = OP).

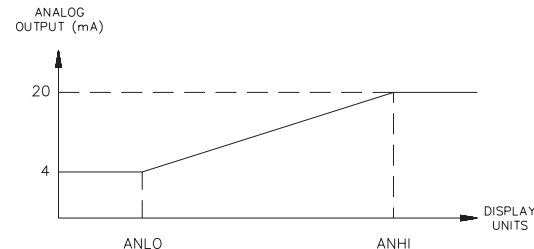

LOCKOUTS MODULE (3-LC)

The controller can be programmed to limit operator access to various parameters, control modes, and display contents. The configuration of the lockouts is grouped into three sections: Lower Display Lockouts, Protected Mode Lockouts and Hidden Mode Lockouts.

Lower Display Lockouts (SP, OP, P-cs, P-tr, UdSP)

The contents of the secondary display can be changed in the normal display mode by successively pressing the DSP button. This scrolls through the four possible display parameters, if enabled. Each parameter can be set for one of the following:

- LOC (Lockout) - Prevents the parameter from appearing in the secondary display.
- rEd (Read only) - Parameter appears, but cannot be modified.
- Ent (Entry) - Parameter appears and can be modified.

The five lower display content possibilities are:

- SP - Setpoint Value
- OP - % Output Power
- P-CS - Profile Control Status
- P-tr - Profile Phase Time Remaining
- UdSP - Temperature Units

If all parameters are set to lock "LOC", the display will remain on the last parameter that was viewed.

Note: If a parameter is active in the lower display and then subsequently locked out, press "DSP" once in the normal display mode to remove it from the display.

Protected Mode Lockouts (Code, PID, & AL)

The protected mode is active when program disable is active. The PID and Alarm parameters can be set for one of the following:

- LOC (Lockout) - Prevents the parameter from appearing in the display
- rEd (Read only) - Parameter appears, but cannot be modified.
- Ent (Entry) - Parameter appears and can be modified.

The PID setting allows access to Proportional Band (ProP), Integral Time (Intt), and Derivative Time (dErt) parameters. Alarm 1 and 2 values (AL1 & AL2) may also be locked out if installed.

A code number to enter the unprotected mode can be programmed into the controller. To enter the unprotected mode from the protected mode, the code number must match the code number entered. Refer to front panel program disable section for access levels.

Code - 0 to 250

Hidden Mode Lockouts (ALrS, CPAC, PrAC, trnF, & tUNE)

The hidden mode is accessible from the normal display mode by pressing and holding the PAR button for three seconds. The parameters can be set for:

- LOC (Lockout) - Prevents the parameter from appearing in the display.
- ENbL (Enable) - Allows operator to perform function.

The five controller functions are executed in hidden mode and are accessible independent of the status of program disable.

- ALrS - Reset (override) an alarm/timed event output(s).
- trnF - Transfer controller from or to automatic to manual operation.
- CPAC - Load 1 of the 4 control points (CP).
- PrAC - Allows the operator to start one of the 4 profiles.
If a profile is running, the status (Adnc, Cont, PAUS, or OFF) can be changed.
- tUNE - Invoke or cancel Auto-Tune.

ALARM MODULE (4-AL) (OPTIONAL)

The controller may be optionally fitted with the dual alarm option (AL1 and AL2), or a single alarm with the cooling output option (AL1 and OP2). One of three types of output modules (Relay, Logic/SSR Drive or Triac) must be ordered separately and installed into the alarm channel socket.

Note: Units with RS-485 serial option must have the same type of modules installed for the Dual Alarms setup.

The output modules may be replaced or interchanged (with appropriate wiring considerations) at any time without re-programming the controller. With an open sensor, the alarm outputs are up-scale drive (+9999) and with a shorted sensor (RTD only) they are down-scale drive (-9999).

A front panel annunciator illuminates to indicate that the alarm output is on (AL1 for alarm 1 and AL2 for alarm 2).

Note: When deviation low-acting with positive alarm value (d-LO), deviation high-acting with negative value (d-HI), or Band inside-acting (b-IN) is selected for the alarm action, the indicator is "OFF" when the alarm output is "ON".

The alarm values can be accessed in configuration module (4-AL), the unprotected mode, and in the protected mode, if not locked.

CAUTION: In applications where equipment or material damage, or risk to personnel due to controller malfunction could occur, an independent and redundant temperature limit indicator with alarm outputs is strongly recommended. Red Lion Controls model IMT (thermocouple) or model IMR (RTD) units may be used for this purpose. The indicators should have independent input sensors and AC power feeds from the other equipment.

Alarm Action (Act1, Act2)

The alarm(s) may be independently configured for one of six possible alarm modes or configured to operate as a timed event output(s). The timed event output(s) are programmed in profiles module 8 (8-Pr).

Absolute High Acting	(A-HI)	
Absolute Low Acting	(A-LO)	
Deviation High Acting	(d-HI)	- Tracks Setpoint Value
Deviation Low Acting	(d-LO)	- Tracks Setpoint Value
Band Inside Acting	(b-in)	- Tracks Setpoint Value
Band Outside Acting	(b-ot)	- Tracks Setpoint Value
Timed Event Output	(P-Ev)	

Note: If an alarm is programmed for Timed Event Output (P-Ev), the remaining alarm parameters are not applicable.

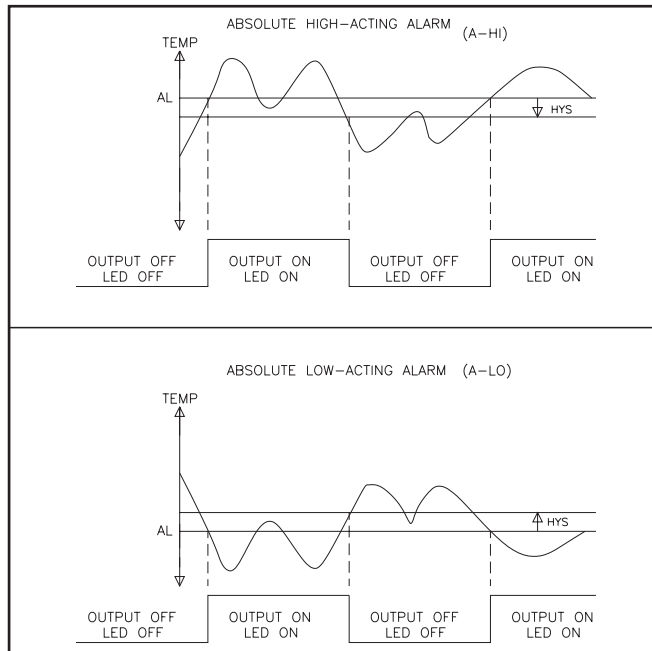

Alarms configured for deviation or band action, track the setpoint during ramp and hold phases of a profile. Deviation and band alarms trigger from the target setpoint when the auto setpoint ramp rate (SPrP) feature is enabled.

The alarm action figures describe the status of the alarm output and the front panel indicator for various over/under temperature conditions. (See output module "OUTPUT ON" state table for definitions, under installing output modules section.) The alarm output waveform is shown with the output in the automatic reset mode.

Note: Select the alarm action with care. In some configurations, the front panel indicator (LED) might be "OFF" while the output is "ON".

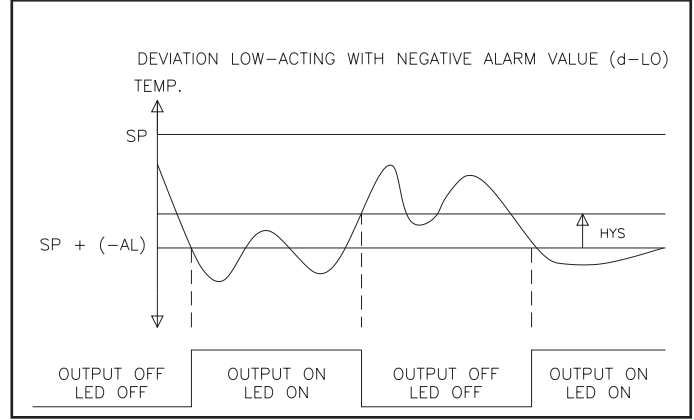
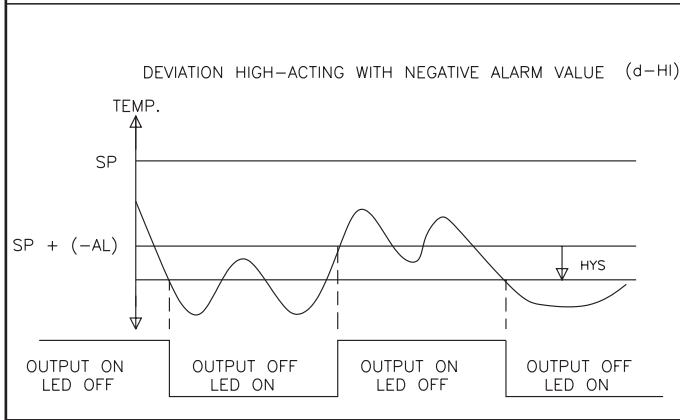
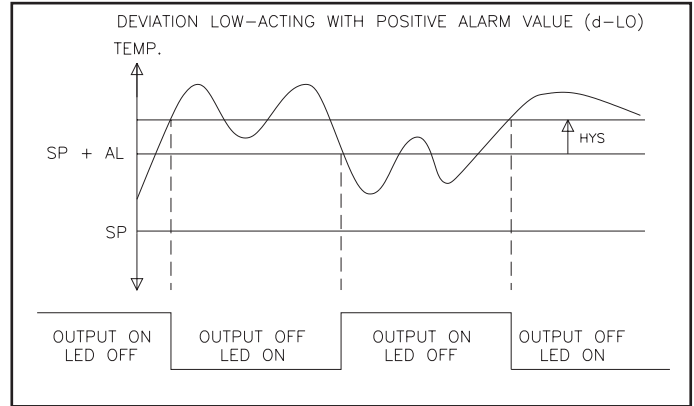
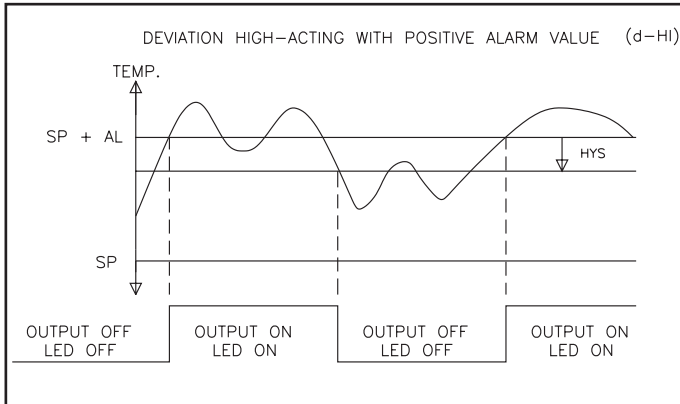

BAND INSIDE ACTING (b-IN)

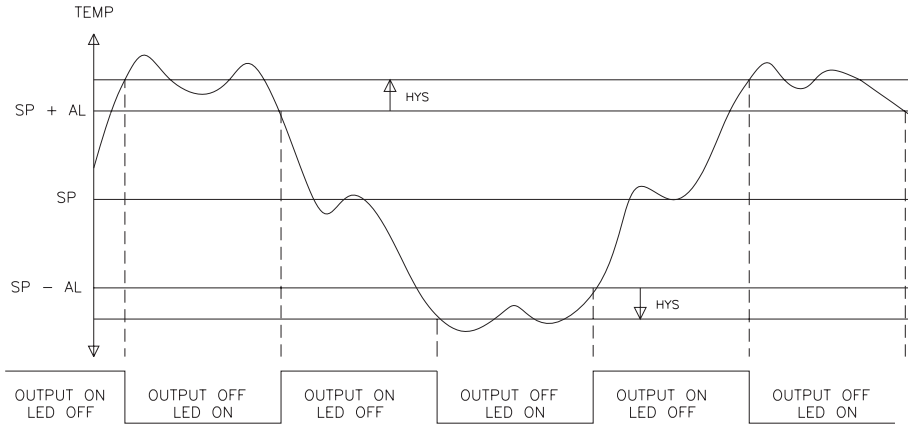

BAND OUTSIDE ACTING (b-OT)

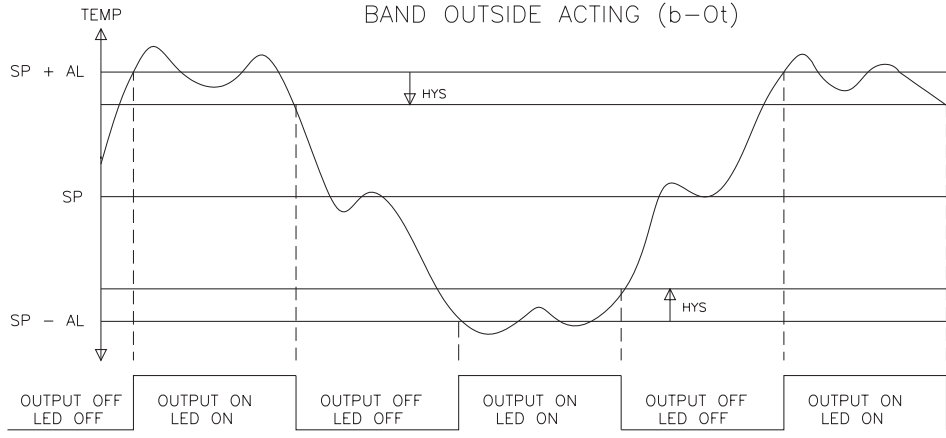

Alarm Reset (rSt1, rSt2)

Each alarm reset action may be independently configured.

- LAtC - Latching
- Auto - Automatic

Latched alarms require operator acknowledgment to reset the alarm condition. The front panel buttons can be used to reset an alarm when the controller is in the hidden mode (see hidden function mode). An Alarm condition may also be reset via the RS-485 serial interface or by the user input. Automatic (Auto) reset alarms are reset by the controller when the alarm condition clears. The alarm reset figure depicts the reset types.

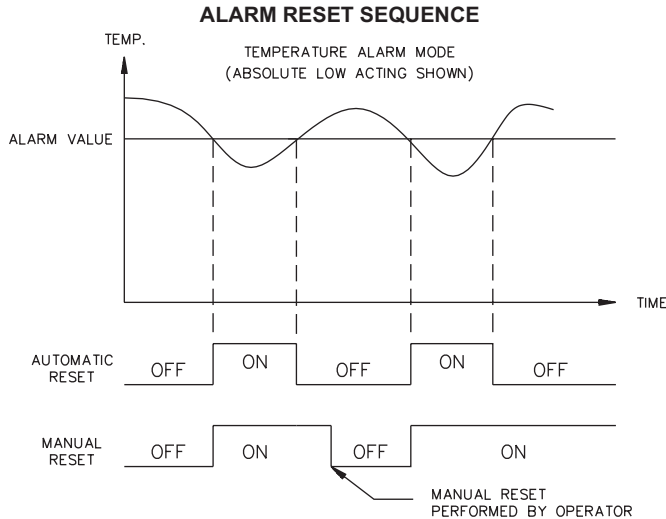

Alarm Standby Delay (Stb1, Stb2)

The alarm(s) may be independently configured to exhibit a power-on, standby delay which suppresses the alarm output from turning "ON" until the temperature first stabilizes outside the alarm region. After this condition is satisfied, the alarm standby delay is canceled and the alarm triggers normally, until the next controller power-on. The alarm standby delay figure depicts a typical operation sequence.

ALARM STANDBY DELAY SEQUENCE

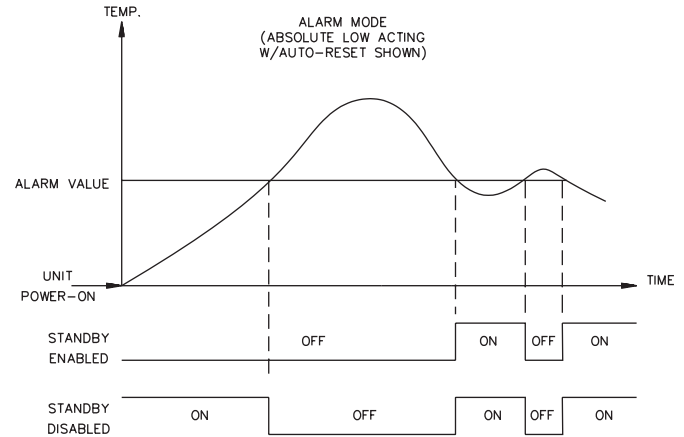

Alarm Value (AL-1, AL-2)

The alarm values are either absolute (absolute alarms) or relative to the setpoint value (deviation and band alarms). An absolute alarm value is the value that is entered. A relative alarm value is offset from the temperature setpoint value by the amount entered and tracks the setpoint value as it changes.

AL-1 and AL-2 - -999 to 9999

If the alarm action is set as a Band Alarm, then only a positive value can be entered.

AL-1 and AL-2 - 0 to 9999

Alarm Hysteresis (AHYS)

The alarm(s) values have a programmable hysteresis band to prevent alarm output chatter near the alarm trigger temperature. The hysteresis value should be set to eliminate this effect. A value of 2 to 5° is usually sufficient for most applications. A single alarm hysteresis value applies to both alarms.

Refer to the alarm action figures for the effect of hysteresis on the various alarm types.

AHYS - 1 to 250 degrees

COOLING OUTPUT PARAMETERS MODULE (5-02) (OPTIONAL)

The optional secondary output (OP2) operates as an independent cooling output for systems that use heating and cooling. One of the three types of output modules (Relay, Logic/SSR Drive or Triac) must be ordered separately and installed into the cooling channel socket.

Note: Units with the RS-485 serial communications option must have the same type of modules installed for the cooling output and alarm output.

The output modules may be replaced or interchanged (with appropriate wiring considerations) at any time without re-programming the controller.

The front panel indicator OP2 illuminates when the cooling output is on. (See Output Module “OUTPUT ON” State Table for definition, under installing output modules section). Cooling output power is defined as ranging from -100% (full cooling) to 0% (no cooling, unless a heat-cool band overlap is used).

Cooling Cycle Time (CYC2)

A value of 0 turns off the cooling output, independent of cooling power demand.

CYC2 - 0 to 120 seconds

Cooling Relative Gain (GAN2)

This parameter defines the gain of the cooling band relative to the heating band. A value of 0.0 places the cooling output into ON/OFF control mode with the Heat-Cool parameter (db-2) becoming the cooling output hysteresis. This may be done independent of the main output control mode (PID or ON/OFF). Relative gain is generally set to balance the effects of cooling to that of heating for best control.

GAN2 - 0.0 to 10.0

Example: If 10 kW of heating and 5kW of cooling is available, initially set the cooling gain to (2.0). The heat/cool operation figure illustrates the effect of different gains.

Heat-Cool Overlap/Deadband (db-2)

This parameter defines the area in which both heating and cooling are active (negative value) or the deadband area between the bands (positive value). The parameter units are degrees or tenths of degrees (depending on system resolution). If a heat/cool overlap is specified, the displayed percent output power is the sum of the heat power (OP1) and the cool power (OP2).

db-2 - -999 to 9999

If cooling relative gain is zero, the cooling output operates in the ON/OFF mode, with this parameter becoming the cooling output hysteresis (positive value only). This parameter should be set prior to Auto-Tune with cooling. The heat/cool operation figures illustrate the effects of different deadbands.

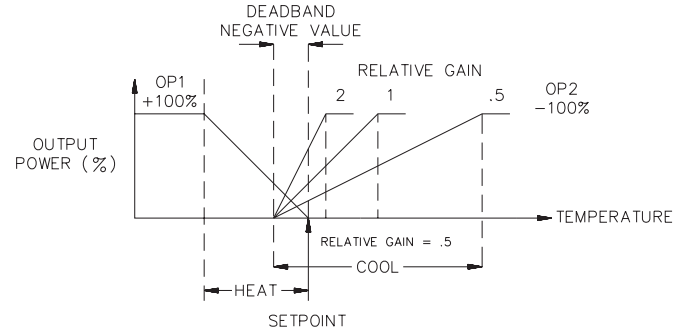
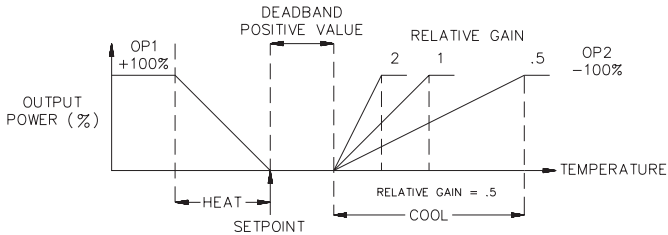
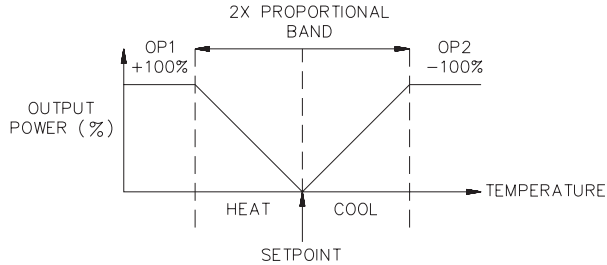

In practice with the cooling output, observe the controlled temperature characteristics and if the temperature remains above setpoint with a sluggish return, increase the cooling gain. Similarly, if the temperature drops too sharply with an overall saw-tooth pattern, decrease the cooling gain. Alter the heat-cool overlap until a smooth response in the controlled temperature is observed during band transition.

SERIAL COMMUNICATIONS MODULE (6-SC) (OPTIONAL)

When communicating with a TSC unit via the serial port, the data formats of both units must be identical. A print operation occurs when the user input, programmed for the print request function is activated, when a “P” command is sent via the serial communications port, or after the time expires for the automatic print rate, if enabled. Serial communication is covered in detail in the RS-485 SERIAL COMMUNICATIONS SECTION.

Baud Rate (bAUd)

The available baud rates are:
300, 600, 1200, 2400, 4800, or 9600

Parity Bit (PARb)

Parity can be odd, even, or no parity.

Address Number (Addr)

Multiple units connected on the same RS-485 interface line must each have a different address number. A value of 0 does not require the address specifier command, when communicating with the TSC. The address numbers range from 0 to 99.

Abbreviated or Full Transmission (Abrv)

When transmitting data, the TSC can be programmed to suppress the address number, mnemonics, units, and some spaces by selecting YES. An example of abbreviated and full transmission are shown below:

NO - 6 SET 123.8F<CR> <LF>	Full Transmission
YES - 123.8<CR> <LF>	Abbreviated Transmission

Print Rate (PrAt)

The TSC can be programmed to automatically transmit the selected print options at the programmed print rate. Selecting 0 disables the automatic print rate feature.

PrAt - 0 to 9999 seconds

Print Options (PoPt)

Selecting YES for the print options will allow the operator to scroll through the available options using the PAR button. The up and down arrow keys toggle between “yes” and “no” with “yes” enabling the option to be printed when a print function occurs.

INP	Print Input Temperature Value
SEt	Print Setpoint Value
OPr	Print % Output Power Value
Pdb	Print % Proportional Band Value
INt	Print Integral Time Value
dEr	Print Derivative Time Value
AL1	Print Alarm 1 Value
AL2	Print Alarm 2 Value
dEv	Print Deviation From Setpoint Value
OFP	Print % Output Power Offset Value
r-P	Print Setpoint Ramp Rate Value
CrG	Print Cooling Relative Gain Value
Cdb	Print Cooling Deadband Value
P-t	Print Profile Phase Time Remaining
P-S	Print Profile Operation Status

CONTROL POINTS MODULE (7-CP)

There are four Control Points, each having a setpoint value and an associated PID gain set value. A control point can be implemented at any time to accommodate changing process requirements due to batch changeover, level changes, etc.

The PID gain set values (ProP, Int, & Dert) may be optionally implemented with the setpoint value. A Control Point can be loaded from the hidden mode or by the user input (control points 1 and 2 only, see user input control point (CP) function).

The control point overwrites the previous setpoint and optionally the PID values. The unit begins controlling based on these new values. When a control point is loaded, the controller suppresses the output 'bump' usually associated with PID gain changes. Control points must be manually loaded and may be used in conjunction with a running profile.

Control Point Set-up (CSEt)

Select the control point to be configured.

NO
CP-1
CP-2
CP-3
CP-4

Selecting NO returns the unit to the configuration access point.

Setpoint Value (SP-n)

Enter the temperature setpoint value for the selected control point. This value is constrained to the setpoint low (SPLO) and setpoint high (SPHI) range limits (see inputs configuration module).

SP-n - -999 to 9999

PID Values(PId)

Choose the option of loading the PID gain set values with setpoint value when implementing a Control Point.

NO - Disables PID entries and returns to control point set-up (CSEt).

YES - PID gain set is implemented when control point is loaded.

Enter the desired PID gain set values.

Pb-n - Proportional Band 0.0 to 999.9%

It-n - Integral Time 0 to 9999 secs

dt-n - Derivative Time 0 to 9999 secs

PROFILES MODULE (8-PR)

Prior to programming a profile, it is recommended to configure the basic controller operation. A profile is a series of one or more programmable ramp and hold phases. A minimum of three parameters are required for a profile:

Ramp Rate (Pnrr)
Target Setpoint (PnLn)
Hold Time (PnHn)

Each profile can be programmed with up to eight ramp and hold phases. Associated with each profile is a timed event output set that updates as the profile advances. Additional parameters are provided which enhance the controller and profile capabilities.

Profile Set-Up

Select which profile or timed event output to program.

PSEt - Pr-1 Profile 1
Pr-2 Profile 2
Pr-3 Profile 3
Pr-4 Profile 4
PE-1 Timed event output for profile 1
PE-2 Timed event output for profile 2
PE-3 Timed event output for profile 3
PE-4 Timed event output for profile 4

The programming parameters for each profile are the same. The operator programs each phase and continues until all eight phases are programmed or a ramp rate of -0.1 is entered. Shown below are the parameters for profile 1.

Pr-1 - P1CC	Cycle count	P1L4	Setpoint level 4
P1L1	Linking	P1H4	Hold time 4
P1St	Power cycle status	P1r5	Ramp rate 5
P1Eb	Error band	P1L5	Setpoint level 5
P1r1	Ramp rate 1	P1H5	Hold time 5
P1L1	Setpoint level 1	P1r6	Ramp rate 6
P1H1	Hold time 1	P1L6	Setpoint level 6
P1r2	Ramp rate 2	P1H6	Hold time 6
P1L2	Setpoint level 2	P1r7	Ramp rate 7
P1H2	Hold time 2	P1L7	Setpoint level 7
P1r3	Ramp rate 3	P1H7	Hold time 7
P1L3	Setpoint level 3	P1r8	Ramp rate 8
P1H3	Hold time 3	P1L8	Setpoint level 8
P1r4	Ramp rate 4	P1H8	Hold time 8

PROFILES MODULE (8-PR) (Cont'd)

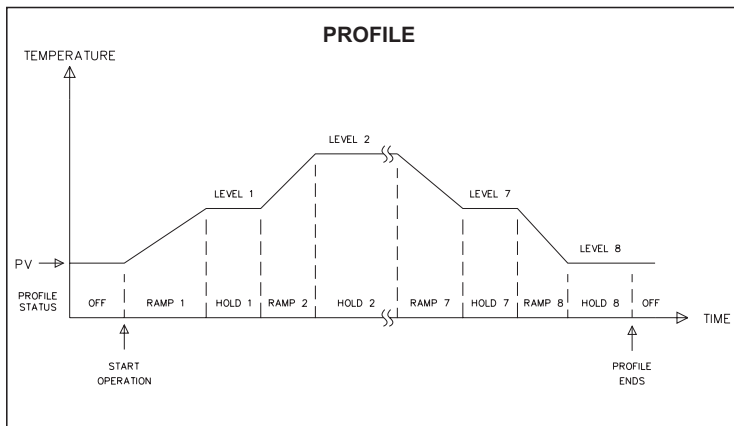

Changes can be made to any profile parameter while the profile is running. Ramp rate, hold time, and setpoint level changes take effect as the profile advances. If a change is made to a phase that is active, the change is not recognized until the next time the profile is run.

From the normal display mode, the phase time remaining and target setpoint value allow temporary changes to a running profile. These changes take effect immediately.

Profile Cycle Count (PnCC)

Once a profile is started, it runs the programmed number of cycles and then automatically defaults to the off mode. If this parameter is changed while the profile is running, the new value does not take effect until the profile is stopped (off mode). It is not possible to examine the number of profile cycle counts that a profile has completed. A cycle count value of 0 prevents the profile from operating. A cycle count value of 250 allows continuous profile cycling.

Profile Linking (PnLn)

Each profile can have up to eight ramp and eight hold phases programmed. If more than eight phases are required, profiles may be linked together. Linking allows the next profile to automatically start when the current profile has completed its cycle count. A single profile can be expanded up to 32 ramp and hold phases of execution by linking.

P1Ln - Selecting YES links profile 1 to profile 2.

P2Ln - Selecting YES links profile 2 to profile 3.

P3Ln - Selecting YES links profile 3 to profile 4.

P4Ln - Selecting YES links profile 4 to profile 1.

Profiles execute the prescribed number of cycle counts prior to linking to the next profile. A linked profile uses the last setpoint value of the previous profile as its starting point. The linking parameter can be changed during profile operation.

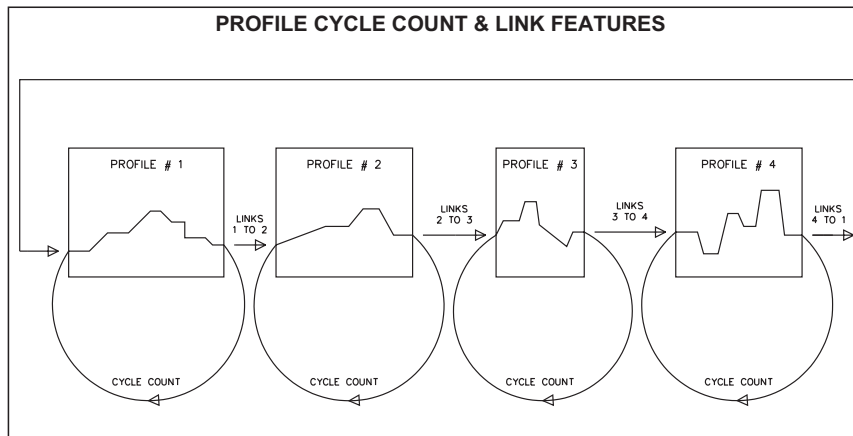

Profile Power Cycle Status (PnSt)

Upon controller power-on, several profile operating modes exist. Each profile has an independent power cycle status.

STOP - Stop places a profile into the Off mode, regardless of the mode prior to power down.

CONT - Continue resumes the operation of a running profile (including event output states) at the point where power was removed to the controller.

Strt - Start automatically re-starts a profile. This is useful for automatic execution, soft-start profile at power-up, or automatic execution of a standard profile.

Power cycle status may be changed while a profile is running. The options of the power cycle status may create conflicts between one or more profiles. The priority structure for the power cycle status is:

Priority #1 - The profile that was running and programmed for continue resumes operation when power is restored.

Priority #2 - If the profile that was running prior to power down is not programmed for continue, any profile programmed for start will re-start. Profile 1 has the highest priority.

Profile Error Band (PnEb)

Profile temperature conformity can be assured by using the profile Error Band parameter. If the process temperature deviates outside the error band value while a profile is running, the controller enters the delay mode. In the delay mode, the time base of the profile is held (delayed) until the process temperature is within the deviation error band. At this time, the profile continues running unless the process temperature again deviates. These actions assure that the actual process temperature conforms to the profile. The error band can be programmed for a positive or negative value which is expressed in degrees.

PnEb - -999 to 9999 degrees

A Positive Error Band value operates on hold phases only. This is useful when temperature soak time must be assured without affecting ramp phase time. A Negative Error Band value allows a profile to enter the delay mode on both ramp AND hold phases. This parameter may be altered during profile operation and the new values takes effect immediately. A value of 0 disables Error Band detection.

Ramp Phase (Pnrr)

The ramp phase is defined as automatic changing (ramping) of the setpoint value over a discrete time period at a predefined rate. The ramp rate is expressed in tenths of degree per minute.

Pnrr - 0.1 to 999.9 degrees/minute

The slope of the ramp phase (up or down) is automatically determined by the controller using the current setpoint value and target setpoint value. Upon starting a profile, the setpoint value begins ramping from the measured input temperature value to the target setpoint value. A profile can begin ramping from a defined setpoint level by entering 0.0 for the first ramp phase and 0.0 for the first hold phase. Entering 0.0 causes the profile to advance directly to the target setpoint value and begin the hold phase. This is known as a Step Ramp Phase. Timed Event outputs update at a Step Ramp Phase. The next ramp phase starts after the hold phase times-out.

A "staged" ramp approach is possible by using hold phase times of 0.0 minutes and redefining the new ramp rate(s).

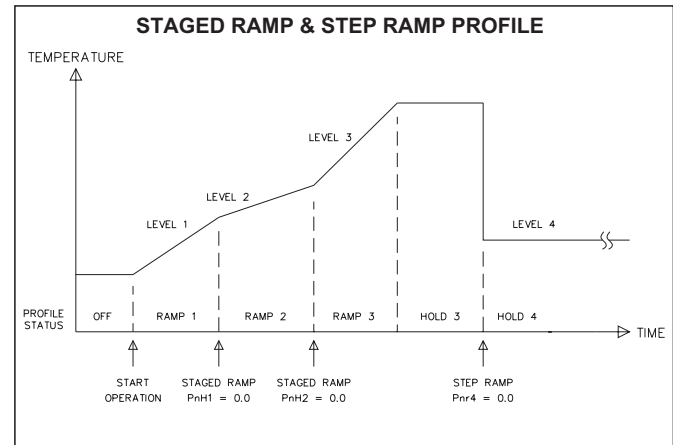

Setpoint Value (PnLn)

The controller ramps to the Target Setpoint Value and then maintains the Target Setpoint Value over the hold phase time. The setpoint value is constrained to the setpoint limit values (SPLO & SPHI).

PnLn - -999 to 9999 degrees

Hold Phase (PnHn)

The controller maintains the target setpoint value constant during a hold phase for a fixed period of time. The hold phase is expressed in tenths of minutes.

0.1 to 999.9 minutes

Holds times longer than 999.9 minutes are possible by joining two or more hold phases. Hold phases are joined by setting the in-between ramp rate to 0.0, which skips the ramp phase.

A hold phase time value of 0.0 minutes skips the hold phase. Although Event Outputs assigned to that phase are updated. Two or more ramp phases (staged ramps) may be joined together by setting the in-between hold phase time to 0.0 minutes.

Timed Event Output(s) (Pn 1 to Pn 16)

The alarm channels can be independently configured to operate as an Alarm Output or a Timed Event Output. *The alarm(s)* must be configured in the Alarm Module (4-AL). If configured as an alarm, the output state assignments are ignored.

Timed Event Outputs use AL1 and/or AL2 to signal or activate other equipment during execution of a profile. The Timed Event Outputs are updated at the start of each ramp and hold phase and remain defined for the duration of that phase. Front panel annunciators AL1 or AL2 light, if the Timed Event Output phase is programmed to activate the corresponding output. The table lists the four assignment choices for each phase:

Mnemonic	Description
1F2F	Alarm 1 off, Alarm 2 off
1F2N	Alarm 1 off, Alarm 2 on
1N2F	Alarm 1 on, Alarm 2 off
1N2N	Alarm 1 on, Alarm 2 on

Each phase of the profile corresponds to an Event Output number. One of the output state assignments is programmed to each profile phase. The table lists the correspondence.

Timed Event Output Number	Profile Phase Mnemonic	Description
Pn 1	Pnr1	Ramp Rate 1
Pn 2	PnH1	Hold Time 1
Pn 3	Pnr2	Ramp Rate 2
Pn 4	PnH2	Hold Time 2
Pn 5	Pnr3	Ramp Rate 3
Pn 6	PnH3	Hold Time 3
Pn 7	Pnr4	Ramp Rate 4
Pn 8	PnH4	Hold Time 4
Pn 9	Pnr5	Ramp Rate 5
Pn 10	PnH5	Hold Time 5
Pn 11	Pnr6	Ramp Rate 6
Pn 12	PnH6	Hold Time 6
Pn 13	Pnr7	Ramp Rate 7
Pn 14	PnH7	Hold Time 7
Pn 15	Pnr8	Ramp Rate 8
Pn 16	PnH8	Hold Time 8

Note: Each Timed Event Output number can be programmed to one of the output states (1F2F, 1F2N, 1N2F, or 1N2N).

If using the Timed Event Outputs for Profile #4, and the other profiles are set for "Stop" operation, the unit will power-up with the outputs in an indeterminate state. To define the Timed Event Outputs under this condition, assign all of the Timed Event Outputs in Profile #4 to off.

Timed Event Output(s) (Pn 1 to Pn 16) (Cont'd)

It is possible to have the Event Outputs operate during profile phases by creating 'phantom' phases, whose sole function is to allow a new state of Event Outputs.

Each profile corresponds to a Timed Event Output.

The Event Output(s) may be manually reset to the off state at any time during profile execution. A timed event output may be reset via the user input (if programmed), the front panel buttons (in the hidden mode), or the RS-485 serial communication option. Once reset they remain in that state until the profile advances to the next phase and the event output updates.

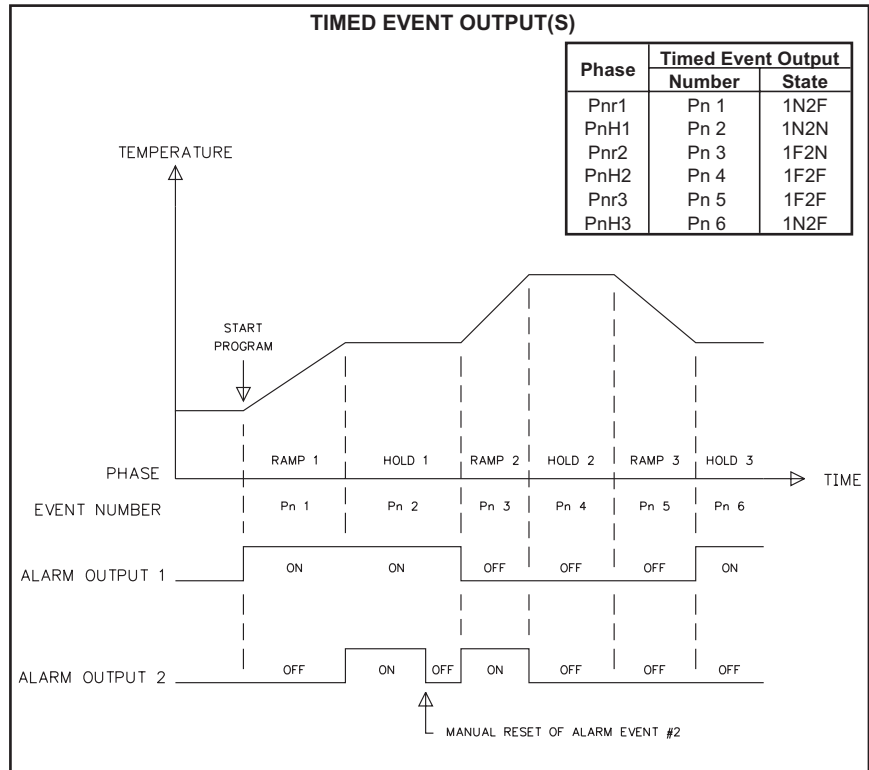

Profile Example

The following example shows the set-up of a profile that executes one time and uses the timed event outputs.

General Requirements:

1. Program data into profile 1.
2. Delay profile if temperature is not within 8 degrees, only during hold phases.
3. Continue profile if power is removed to the controller.
4. Implement User Input for profile 1 run/pause operation.

Profile Requirements:

- A. Ramp up from idle process temperature of 85° to 350° at 4.0°/minute (ramp time = 66.3 minutes). Hold at 350° for 20.0 minutes.
- B. Ramp up from 350° to 500° at 3.0°/minute (ramp time = 50.0 minutes). Hold at 500° for 60.0 minutes.
- C. Step ramp up from 500° to 750°. No hold phase at 750°.
- D. Ramp up from 750° to 875° at 7.5°/minute (ramp time = 16.7 minutes). Hold at 875° for 2.5 hours (150 minutes).
- E. Ramp down from 875° to 250° at 10.0°/minute (ramp time = 62.5 minutes). Engage auxiliary cooling during this ramp (Event output 1).
- F. No hold phase at 250°. Turn off auxiliary cooling.
- G. Ramp down from 250° to 100° at 3.75°/minute (ramp time = 40.0 minutes). No hold phase at 100°. Turn on end of program signal (Event output #2).
- H. End program at 100°.

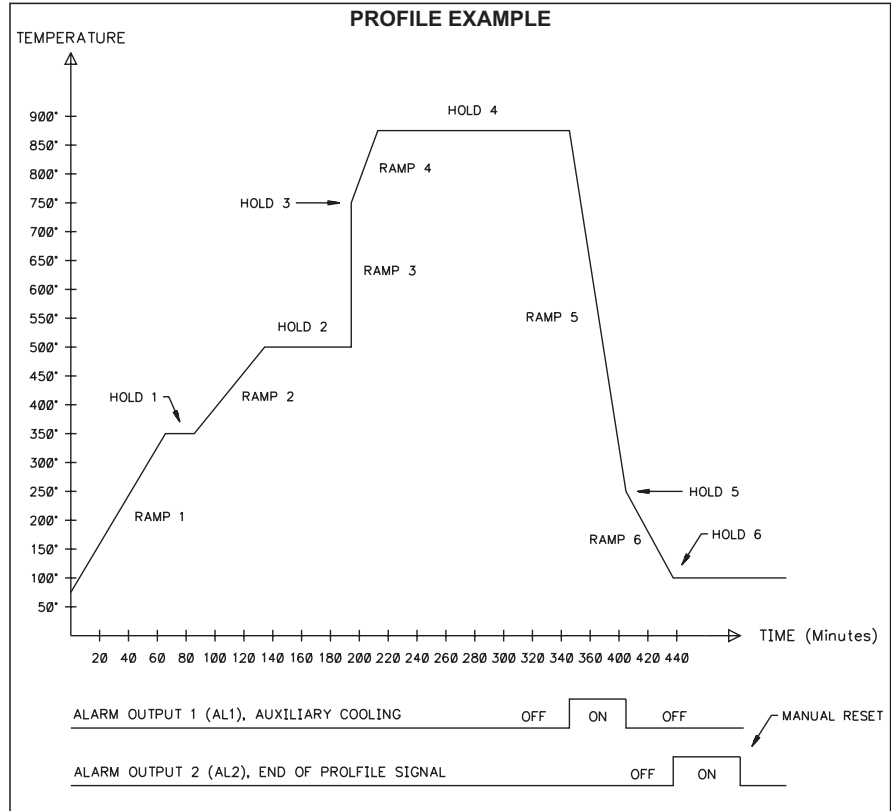

The Programming Data For The Example:

Input Module 1 (1-IN)

Mnemonic	Value	Description
InPt	P1rH	User input is programmed for run/pause operation

Alarm Module 4 (4-AL)

Mnemonic	Value	Description
Act 1	P-Ev	Program alarm 1 for timed event output
Act 2	P-Ev	Program alarm 2 for timed event output

Profile Module 8 (8-Pr)

Mnemonic	Value	Description
P1CC	1	Cycle profile once after started
P1Ln	no	Do not link to profile 2 when done
P1St	Cont	Continue profile operation when power is restored
P1Eb	8	Delay mode if temperature deviates $\pm 8^{\circ}$
P1r1	4.0	Ramp rate 1 is 4.0/minute
P1L1	350	Setpoint level 1 is 350
P1H1	20.0	Hold time 1 is 20.0 minutes
P1r2	3.0	Ramp rate 2 is 3.0/minute
P1L2	500	Setpoint level 2 is 500
P1H2	60.0	Hold time 2 is 60.0 minutes
P1r3	0.0	Ramp rate 3 is step ramp
P1L3	750	Setpoint level 3 is 750
P1H3	0.0	Hold time 3 is skipped
P1r4	7.5	Ramp rate 4 is 7.5/minute
P1L4	875	Setpoint Level 4 is 875
P1H4	150.0	Hold time 4 is 150.0 minutes
P1r5	10.0	Ramp rate 5 is 10.0/minute
P1L5	250	Setpoint level 5 is 250
P1H5	0.0	Hold time 5 is skipped
P1r6	3.8	Ramp rate 6 is 3.8/minute
P1L6	100	Setpoint level 6 is 100
P1H6	0.0	Hold time 6 is skipped
P1r7	-0.1	Ramp rate 7 ends profile

Profile Module 8 (8-Pr) (Cont'd)

Mnemonic	Value	Description
P1 1	1F2F	Keep both outputs off
P1 2	1F2F	Keep both outputs off
P1 3	1F2F	Keep both outputs off
P1 4	1F2F	Keep both outputs off
P1 5	1F2F	Keep both outputs off
P1 6	1F2F	Keep both outputs off
P1 7	1F2F	Keep both outputs off
P1 8	1F2F	Keep both outputs off
P1 9	1N2F	Turn on auxiliary cooling
P110	1F2F	Turn off auxiliary cooling
P111	1F2F	Keep both outputs off
P112	1F2N	Turn on end of profile signal

FACTORY SERVICE OPERATIONS MODULE (9-FS)

The Factory Service Operations are programming functions which are performed on an infrequent basis. They include: controller calibration, and reset programming to factory configuration setting. Given the ramifications of these operations, access to each is protected by an access code number. Entering code 66 will restore all parameters to factory settings, the unit will indicate the operation after the PAR button is pressed, by displaying "rSEt" in the lower display momentarily. The calibration operations are detailed in Appendix "F".

Note: Entering code 66 will reset all programming parameters to the factory settings.

QUICK REFERENCE TABLE: CONFIGURATION INPUT MODULE 1 (1-IN)

Display	Parameter	Range and Units (Factory Setting Value)	Description/ Comments
tYPE	Input type	tc-t - Type T TC tc-E -Type E TC tc-J - Type J TC tc-k - Type K TC tc-r - Type R TC tc-S - Type S TC tc-B - Type B TC tc-N - Type N TC LIN - Linear mV display	If changed, check PID settings and input select jumper position. (jumper in TC position)
		r385 - 385 curve RTD r392 - 392 curve RTD rLIN - Linear ohms display (tc-J)	(jumper in RTD position)
SCAL	Temperature scale	°F/°C (°F)	If scale is changed, all parameters must be checked.
dCPt	Temperature resolution	0 or 0.0 (0)	If resolution changed, all parameters must be checked.
FLtr	Digital filtering for input signal	0 to 3 (1)	Increase number for more filtering effect.
SPAN	Input signal slope (correction factor)	0.001 to 9.999 (1.000)	Normally set to 1.000
SHFt	Input signal offset (correction shift)	-999 to 9999 1 or 0.1 degree (0)	Normally set to 0
SPLO	Lower limit setpoint range	-999 to 9999 1 or 0.1 degree (0)	Set low limit below high limit.
SPHI	Upper limit setpoint range	-999 to 9999 1 or 0.1 degree (9999)	Set high limit above low limit.

Display	Parameter	Range and Units (Factory Setting Value)	Description/ Comments
SPrP	Setpoint ramp rate	0.0 to 999.9 degrees/minute (0.0)	0.0 is off (no auto ramping) (Not related to profile operation.)
InPt	User input	PLOC - Program disable ILOC - Integral action on/off trnF - Auto/manual transfer SPrP - Ramp rate on/off ALrS - Reset alarm output(s) Pmt - Print request CP - Control point load P1rH - Run/pause a profile or start profile 1 P1rS - Profile 1 stop/restart (PLOC)	

QUICK REFERENCE TABLE: CONFIGURATION OUTPUT MODULE 2 (2-OP)

Display	Parameter	Range and Units (Factory Setting Value)	Description/ Comments
CYct	Cycle time	0 to 120 seconds (2)	0 turns OP1 off.
OPAC	Control action	drct - cooling rEv - heating (rev)	For both PID & ON/OFF control.
OPLO	Output power lower limit range	0% to 100%, OP1 -100% to 100%, OP1 & OP2 (0, no cooling) (-100, cooling)	Set OPLO < OPHI If cooling option is installed.
OPHI	Output power upper limit range	0% to 100%, OP1 -100% to 100%, OP1 & OP2 (100)	Set OPHI > OPLO If cooling option is installed.
OPFL	Sensor fail power preset	0% to 100%, OP1 -100% to 100%, OP1 & OP2 (0)	Set to a value to safely control the process in the event of input sensor failure.
CHYS	ON/OFF control hysteresis	1 to 250 1 or 0.1 degree (1)	Heating side only.
tcod	Auto-tune damping code	0 to 4 (0)	0 = fastest response 4 = slowest response
ANAS	Linear DC output assignment	OP - % output power INP - input temp. SP - setpoint value dEv - deviation (OP)	This parameter does not appear if analog option is not installed.
ANLO	Linear DC output low scaling value	-999 to 9999 (0.0)	Units depend on ANAS selection. This parameter does not appear if analog option is not installed.
ANHI	Linear DC output high scaling value	-999 to 9999 (100.0)	Units depend on ANAS selection. This parameter does not appear if analog option is not installed.

QUICK REFERENCE TABLE: CONFIGURATION LOCKOUT MODULE 3 (3-LC)

Display	Parameter	Range and Units (Factory Setting Value)	Description/ Comments
SP	Setpoint access	LOC - lockout rEd - read only Ent - enter (Ent)	Allows access to temperature setpoint
OP	Output power access	LOC - lockout rEd - read only Ent - enter (Ent)	Allows direct access to output power. %PW indicator illuminates when parameter is selected in display.
P-CS	Profile status display	LOC - lockout rEd - read only Ent - enter (rEd)	Allows access to profile status. PGM indicator illuminates when parameter is selected in display.
P-tr	Profile time remaining	LOC - lockout rEd - read only Ent - enter (rEd)	Allows access to phase time remaining. PGM indicator illuminates when parameter is selected in display
UdSP	Units display	LOC - lockout rEd - read only Ent - enter (rEd)	Allows display of °F or °C
Code	Access code	0 to 250 (0)	Refer to front panel disable section for access levels.
PId	PID values enable	LOC - lockout rEd - read only Ent - enter (LOC)	Protected mode lockout
AL	Alarm values enable	LOC - lockout rEd - read only Ent - enter (LOC)	Protected mode lockout
ALrS	Reset alarm/timed event outputs enable	LOC - lockout ENBL - enable (LOC)	Hidden mode lockout

Display	Parameter	Range and Units (Factory Setting Value)	Description/ Comments
CPAC	Control point access	LOC - lockout ENBL - enable (LOC)	Hidden mode lockout
PrAC	Ramp/hold profile access	LOC - lockout ENBL - enable (LOC)	Hidden mode lockout
trnF	Automatic / Manual (user) transfer enable	LOC - lockout ENBL - enable (LOC)	Hidden mode lockout
tuNE	Auto-tune enable	LOC - lockout ENBL - enable (LOC)	Hidden mode lockout

QUICK REFERENCE TABLE: CONFIGURATION ALARMS MODULE 4 (4-AL)

Unit returns to configuration access point if alarm(s) are not installed.

Display	Parameter	Range and Units (Factory Setting Value)	Description/ Comments
Act1	Alarm 1 operation mode	A-HI absolute high A-LO absolute low d-HI deviation high d-LO deviation low b-IN band inside b-ot band outside P-Ev timed event output (A-HI)	If changed, check alarm values. If P-Ev is selected, remaining parameters for Alarm 1 does not appear.
rSt1	Alarm 1 reset mode	Auto - automatic LAtc - manual reset (Auto)	Manual reset via hidden mode.
Stb1	Alarm 1 standby function (delay)	yes/no (no)	Power-up standby delay
AL-1	Alarm 1 value	-999 to 9999 1 or .1 degree (0)	If band alarm action, positive values only.
Act2	Alarm 2 operation mode	A-HI absolute high A-LO absolute low d-HI deviation high d-LO deviation low b-IN band inside b-ot band outside P-Ev timed event output (A-HI)	If changed, check alarm values. If P-Ev is selected, remaining parameters for Alarm 2 does not appear.
rSt2	Alarm 2 reset mode	Auto - automatic LAtc - manual reset (Auto)	Manual reset via hidden mode.
Stb2	Alarm 2 standby function (delay)	yes/no (no)	Power-up standby delay
AL-2	Alarm 2 value	-999 to 9999 1 or .1 degree (0)	If band alarm action, positive values only.
AHYS	Alarm Hysteresis value	1 to 250 1 or .1 degree (1)	Applies to both alarms. Set to eliminated chatter.

QUICK REFERENCE TABLE: CONFIGURATION COOLING MODULE 5 (5-02)

Unit returns to configuration access point if cooling option not installed.

Display	Parameter	Range and Units (Factory Setting Value)	Description/ Comments
CYC2	Cooling output cycle time	0 to 120 sec (2)	0 turns OP2 off.
GAN2	Relative cooling gain	0.0 to 10.0 (1.0)	0.0 places cooling output into ON/OFF control mode and db-2 becomes hysteresis value.
db-2	Heating/cooling overlap-deadband	-999 to 9999 (0)	Positive value is deadband. Negative value is overlap. If GAN2 = 0, this parameter is cooling ON/OFF control hysteresis.

QUICK REFERENCE TABLE: CONFIGURATION SERIAL COMMUNICATIONS MODULE 6 (6-SC)

Unit returns to configuration access point if RS-485 serial option is not installed.

Display	Parameter	Range and Units (Factory Setting Value)	Description/ Comments
bAUd	Baud rate	300 to 9600 (1200)	Baud rate of unit must match other equipment.
PArb	Parity bit	odd, even, no parity (odd)	Parity of unit must match other equipment.
Add	Unit address	0 to 99 (0)	For multiple units, each unit must have a unique address.
Abr	Abbreviated or full transmission	yes/no (no)	Selecting yes, the controller does NOT transmit mnemonics.
PrAt	Auto print rate	0 to 9999 (0)	0 disables auto print function
PoPt	Print options	Yes/no (no)	Selecting yes allows print options to be programmed.
INP	Input Temperature	Yes/no (yes)	
SEt	Setpoint	Yes/no (yes)	
OPr	% Output Power	Yes/no (yes)	
Pdb	% Proportional Band	Yes/no (no)	
INt	Integral Time	Yes/no (no)	
dEr	Derivative Time	Yes/no (no)	
AL1	Alarm 1	Yes/no (no)	
AL2	Alarm 2	Yes/no (no)	
dEv	Deviation From Setpoint	Yes/no (no)	
OFp	% Output Power Offset	Yes/no (no)	
r-P	Setpoint Ramp Rate	Yes/no (no)	
CrG	Cooling Relative Gain	Yes/no (no)	
Cdb	Cooling Deadband	Yes/no (no)	
P-t	Profile Phase Time Remaining	Yes/no (no)	
P-S	Profile Operation Status	Yes/no (no)	

QUICK REFERENCE TABLE: CONFIGURATION CONTROL POINT MODULE 7 (7-CP)

Display	Parameter	Range and Units (Factory Setting Value)	Description/ Comments
CSEt	Control Point set-up	NO CP-1 CP-2 CP-3 CP-4 (NO)	NO - Return to CONF Control Point 1 Control Point 2 Control Point 3 Control Point 4
<i>The parameters for the four Control Points are the same. (n = control point 1, 2, 3, or 4.)</i>			
SP-n	Setpoint value for Control Point n	SPLO to SPHI 1 or .1 degree (0)	Limited to setpoint limit values.
PId	PID gain set for Control Point n	NO - disable PID, return to CSEt yES - continue with entry of PID (NO)	PID values to be loaded with setpoint entry, when implemented.
Pb-n	Proportional band for Control Point n	0.0 to 999.9% (4.0)	0.0% = ON/OFF control
It-n	Integral time for Control Point n	0 to 9999 seconds (120)	0 is off. Does not appear in Pb-n = 0.0%
dt-n	Derivative time for Control Point n	0 to 9999 seconds (30)	0 is off. Does not appear in Pb-n = 0.0%
<i>Return to "CSet" to program other Control Points if desired.</i>			

QUICK REFERENCE TABLE: CONFIGURATION PROFILE MODULE 8 (8-PR)

Display	Parameter	Range and Units (Factory Setting Value)	Description/ Comments
PSEt	Setpoint Profile	NO Pr-1 Pr-2 Pr-3 Pr-4 PE-1 PE-2 PE-3 PE-4 (NO)	NO - Return to CNFP Profile 1 Profile 2 Profile 3 Profile 4 Time event output for profile 1 Time event output for profile 2 Time event output for profile 3 Time event output for profile 4
<i>The parameters for the four profiles are the same. (Pn = profile 1, 2, 3, or 4)</i>			
PnCC	Profile n cycle count	0-250 (0)	0 = off 250 = continuous
PnLn	Profile n link option	YES/NO (NO)	Link if more than 8 ramp/soak phases are required.
PnSt	Profile n power-on status	Stop- Stop profile CONT - Continue profile Strt - Start profile (Stop)	Continue has priority.
PnEb	Profile n error band	-999 to 9999 1 or .1 degree (0)	0 = off. (+) Values hold phases only (-) values ramp and hold phases
Pnr1	Profile n ramp rate	0.0 to 999.9 degrees/minute (0.0)	0.0 = step (instant ramp) -0.1 ends the profile.
PnL1	Profile n setpoint level 1	SPLO to SPHI 1 or .1 degree (0)	Constrained to setpoint limit values.
PnH1	Profile n hold time 1	0.0 to 999.9 minutes (0.0)	0.0 = no hold phase.
<i>Program up to 8 ramp/hold phases. Profile ends when ramp = -0.1 or PnH8 is programmed.</i>			

Display	Parameter	Range and Units (Factory Setting Value)	Description/ Comments
Pnr8	Profile n ramp rate 8	0.0 to 999.9 degrees/minute (0.0)	Same as ramp 1.
PnL8	Profile n setpoint level 8	SPLO to SPH 1 or .1 degree (0)	Same as setpoint 1.
PnH8	Profile n hold time 8	0.0 to 999.9 minutes (0.0)	Same as hold 1.
<i>Profile returns to "PSEt" stage.</i>			
<i>The parameters for the four timed event outputs are the same. (Pn = Timed Event Output for profile 1, 2, 3, or 4.)</i>			
Pn 1	Event output number 1 for profile n	1F2F 1F2N 1N2F 1N2N (1F2F)	Assign alarms to timed event output in alarm action. F = OFF; N = ON 1 = AL1; 2 = AL2
<i>Each event output has the same programmable options. Event updates end when profile ends.</i>			
Pn 16	Event output number 16, for profile n	1F2F 1F2N 1F2F 1N2N (1F2F)	Assign alarms to timed event output in alarm action. F = OFF; N = ON 1 = AL1; 2 = AL2
<i>Event Output step returns to "PSEt" stage.</i>			

QUICK REFERENCE TABLE: CONFIGURATION FACTORY SERVICE OPERATIONS MODULE 9 (9-FS)

Display	Parameter	Range and Units (Factory Setting Value)	Description/ Comments
Code	Enter factory service function code	48 - Calibrate instrument	Refer to Appendix F for details.
		66 - Reset parameters to factory settings	

RS-485 SERIAL COMMUNICATIONS INTERFACE

RS-485 communications allows for transmitting and receiving of data over a single pair of wires. This optional feature can be used for monitoring various values, resetting output(s), and changing values, all from a remote location. Typical devices that are connected to a TSC unit are a printer, a terminal, a programmable controller, or a host computer.

The RS-485 differential (balanced) design has good noise immunity and allows for communication distances of up to 4000 feet. Up to 32 units can be connected on a pair of wires and a common. The RS-485 is isolated from the controller input signal common to eliminate ground loop problems associated with the input probe. The unit's address can be programmed from 0 to 99. An Optional RLC Serial Converter Module (RS-422 to 20 mA current loop) can be installed to expand the unit's flexibility.

COMMUNICATION FORMAT

The half-duplex communication operation sends data by switching voltage levels on the common pair of wires. Data is received by monitoring the levels and interpreting the codes that were transmitted.

In order for data to be interpreted correctly, there must be identical formats and baud rates between the communicating devices. The formats available for the TSC unit are 1 start bit, 7 data bits, No parity or 1 parity bit (odd or even) and 1 stop bit. The programmable baud rates are; 300, 600, 1200, 2400, 4800, or 9600 baud.

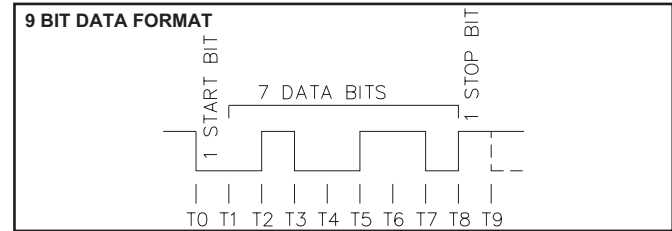
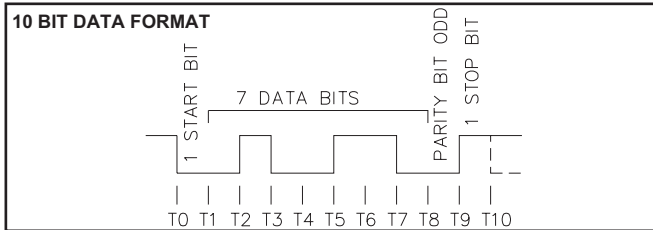

Before serial communication can take place, the unit must be programmed to the same baud rate and parity as the connected equipment. In addition, the loop address number and print options should be known. When used with a terminal or host computer and only one unit is employed, an address of zero (0) may be used to eliminate the requirement for the address specifier when sending a command. If more than one unit is on the line, each unit should be assigned a different address number.

SENDING COMMANDS AND DATA

When sending commands to a TSC unit, a command string must be constructed. The command string may consist of command codes, value identifiers, and numerical data. Below is a list of commands and value identifiers that are used when communicating with the TSC unit.

COMMAND	DESCRIPTION
N (4EH)	Address command; Followed by a one or two digit address number 0-99.
P (50H)	Transmit print options command; Transmits the options selected in the Program Options (PoPt) section
R (52H)	Reset command; Followed by one of the Value Identifiers (G or H)
T (54H)	Transmit value command; Followed by one of the Value Identifiers (A-M, O, Q).
C (43H)	Control action command; Followed by the Value Identifier (S or U) and number.
V (56H)	Change value command; Followed by one Value Identifier (B-H & J-M, O), then the proper numerical data.

VALUE IDENTIFIER	DESCRIPTION	SERIAL MNEMONIC	UNITS
A	Temperature Display Value	TMP	F/C
B	Setpoint	SET	F/C
C	Output Power	PWR	%
D	Proportional Band	PBD	%
E	Integral Time	INT	S
F	Derivative Time	DER	S
G	Alarm 1	AL1	F/C
H	Alarm 2	AL2	F/C
I	Deviation	DEV	F/C
J	Output Power Offset	OPF	%
K	Setpoint Ramp Rate *	RMP	R
L	Cooling Relative Gain	CRG	G
M	Cooling Deadband	CDB	F/C
O	Program Phase Time Remaining	TIM	M
Q	Program Phase Status	STS	--
S	Control Mode 1 - Automatic 2 - Manual (User)	--	--
U	1 = Start Profile 1 Operation 2 = Start Profile 2 Operation 3 = Start Profile 3 Operation 4 = Start Profile 4 Operation 5 = Stop Profile Operation 6 = Pause Profile Operation 7 = Continue Profile Operation 8 = Advance Profile to Next Phase	-- -- -- -- -- -- -- --	-- -- -- -- -- -- -- --

Note: The % output power can be changed only if the controller is in the manual mode of operation.

Profile data cannot be configured via the serial interface. Only status changes can be made to a running profile.

* The Auto Setpoint Ramp Rate is not associated with a profile. This parameter is programmed in the Input Parameter Module (1-IN) (see Setpoint Ramp Rate for details).

A command string is constructed by using a command, a value identifier, and a data value if required. The Data value need not contain the decimal point since it is fixed within the unit, when programmed at the front panel. The TSC will accept the decimal point, however it does not interpret them in any way. Leading zeros can be eliminated, but all trailing zeros must be present.

Example: If an alarm value of 750.0 is to be sent, the data value can be transmitted as 750.0 or 7500. If a 750 is transmitted, the alarm value is changed to 75.0 in the unit.

The address command allows a transmission string to be directed to a specific unit on the serial communications line. When the unit address is zero, transmission of the address command is not required. For applications that require several units, it is recommended that each unit on the line be assigned a specific address.

If they are assigned the same address, a Transmit Value Command, will cause all the units to respond simultaneously, resulting in a communication collision.

The command string is constructed in a specific logical sequence. The TSC does not accept command strings that do not follow this sequence. Only one operation can be performed per command string.

- The following procedure should be used when constructing a command string.
1. The first two to three characters of the command string must consist of the Address Command (N) and the address number of the unit (0-99). If the unit address is zero, the address command and number need NOT be sent.
 2. The next character in the command string is the command that the unit is to perform (P, R, T, C, or V).
 3. A Value Identifier is next if it pertains to the command. The command P (print) does not require a Value Identifier.
 4. The numerical data will be next in the command string if the “Change Value” or “Control Action” command is used.
 5. All command strings must be terminated with an asterisk * (2AH). This character indicates to the unit that the command string is complete and begins processing the command.

Below are typical examples of command strings.

- Ex. 1 Change Proportional Band Value to 13.0% on the unit with an address of 2.
Command String: N2VD130*
- Ex. 2 Transmit the Temperature Value of the unit with an address of 3.
Command String: N3TA*
- Ex. 3 Reset Alarm Output 1 of the unit with an address of 0.
Command String: RG*
- Ex. 4 Start profile 1 of the unit with an address of 13.
Command String: N13CU1*

If illegal commands or characters are sent to the TSC, the string must be re-transmitted.

SENDING COMMANDS AND DATA (Cont'd)

When writing application programs in Basic, the transmission of spaces or carriage return and line feed should be inhibited by using the semicolon delimiter with the "PRINT" statement. The unit does not accept a carriage return or line feed as valid characters.

It is recommended that a "Transmit Value" command follow a "Change Value" Command. If this is done, the reception of the data can provide a timing reference for sending another command and insures that the change has occurred. When a "Change Value or Reset" command is sent to the unit, there is time required for the unit to process the command string. The diagrams show the timing considerations that need to be made.

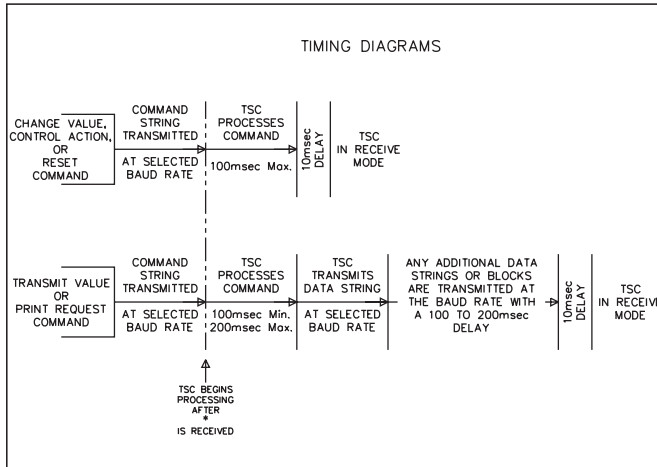

RECEIVING DATA

Data is transmitted from the TSC when a "T" Transmit Value or a "P" Transmit Print Options command is sent to the unit via the serial port. Also, when the User Input, programmed for the Print Request function, is activated. The print rate features allows the selected print options to be transmitted at a programmable automatic rate via the serial port. The format for a typical transmission string with mnemonics is shown below:

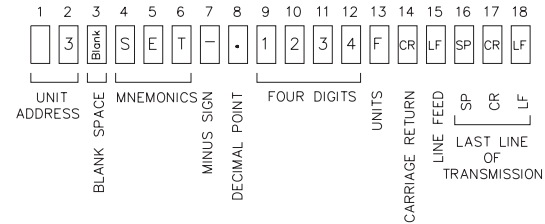

The first two digits transmitted are the unit address followed by one blank space. If the unit address is 0, the first locations are blank. The next three characters are the mnemonics followed by one or more blank spaces. The numerical data value is transmitted next followed by the identifying units. Negative values are indicated by a "-" sign.

The decimal point position "floats" within the data field depending on the actual value it represents. The numeric data is right justified without leading zeros.

When a "T" command or print request is issued, the above character string is sent for each line of a block transmission. An extra <SP><CR><LF> is transmitted following the last line of transmission from a print request, to provide separation between print outs.

If abbreviated transmission is selected, just numeric data is sent. If abbreviated transmission is NOT selected, the unit transmits Mnemonics and the units.

If more than one string is transmitted, there is a 100 msec minimum to 200 msec maximum built-in time delay after each transmission string and after each block of transmission. When interfacing to a printer, sending mnemonics are usually desirable. Examples of transmissions are shown below:

```
1 TMP 500F<CR><LF>100 - 200 msec      Mnemonics Sent
1 SET 525F<CR><LF>100 - 200 msec
1 PWR 20%<CR><LF><SP><CR><LF>100 - 200 msec
-673.5<CR><LF>100 - 200 msec          NO Mnemonics Sent
```

The Print Options provide a choice of which TSC data values are to be transmitted. The TSC will transmit the Print Options when either the User Input, programmed for the print request function is activated, a “P” (Transmit Print Options) command is sent to the TSC via the serial port, or the Automatic Print Rate is set for a specific time. The Print Options are programmed in the Serial Communications Module (6-SC) with the available options:

1. Print Display Temperature Value.
2. Print Setpoint Value.
3. Print % Output Power Value.
4. Print % Proportional Band Value.
5. Print Integral Time Value.
6. Print Derivative Time Value.
7. Print Alarm 1 Value.
8. Print Alarm 2 Value.
9. Print Deviation From Setpoint Value.
10. Print % Output Power Offset Value.
11. Print Setpoint Ramp Rate Value.
12. Print Cooling Relative Gain Value.
13. Print Cooling Deadband Value.
14. Print Profile Phase Time Remaining.
15. Print Profile Status.

A print out from a TSC unit with an address of 1 and all print options selected is shown below:

```
1 TMP      500F
1 SET      525F
1 PWR      20.0%
1 PBD      4.0%
1 INT      120S
1 DER      30S
1 AL1      600F
1 AL2      475F
1 DEV      -25F
1 OFP      0.0%
1 RMP      0.0R
1 CRG      1.0G
1 CDB      10F
1 TIM      1.6M
1 STS      P2H3
```

Note: If the cooling option is installed, AL2 is not printed or functional.

SERIAL CONNECTIONS

When wiring the terminal block at the rear of the unit, refer to the label with the terminal description for installing each wire in its proper location. It is recommended that shielded (screened) cable be used for serial communications. This unit meets the EMC specifications using Alpha #2404 cable or equivalent. There are higher grades of shielded cable, such as four conductor twisted pair, that offer an even higher degree of noise immunity. Only two transceiver wires and a common are needed.

The two data (transceiver) wires connect to the TX/RX(+) and TX/RX(-) terminals, appropriately.

The cable should consist of a shielded twisted pair and in some applications a signal ground may be required to establish a ground reference. The signal ground is required if the equipment does not have internal bias resistors connected to the RS-485 transceiver lines. The signal ground is connected at the RS-485 common of only one TSC unit to the RS-485 equipment. If necessary, the shield can be used as the signal ground.

The signal input common is isolated from the RS-485 common and the analog output “-” terminal.

Note: Do NOT connect any of the commons to the 4-20 mA output “-” terminal.

Terminal Descriptions

RS-485 COMM. - Common may be required for communication hook-up.

TX/RX (+) & TX/RX (-) - The TSC transmits and receives on these two terminals which are connected to the external device.

TX EN. - Used with a Red Lion Controls (RLC) GCM422 Serial Converter Module (RS422 to 20 mA Loop). Otherwise not normally used.

Connecting To A Host Terminal

Six TSC units are used to control a process in a plant. The TSC units are located at the proper location to optimize the process. A communication line is run to an industrial computer located in the production office. The drawing shows the line connection. Each TSC is programmed for a different address and are all programmed for the same baud rate and parity as the computer (ex 9600 baud, parity even).

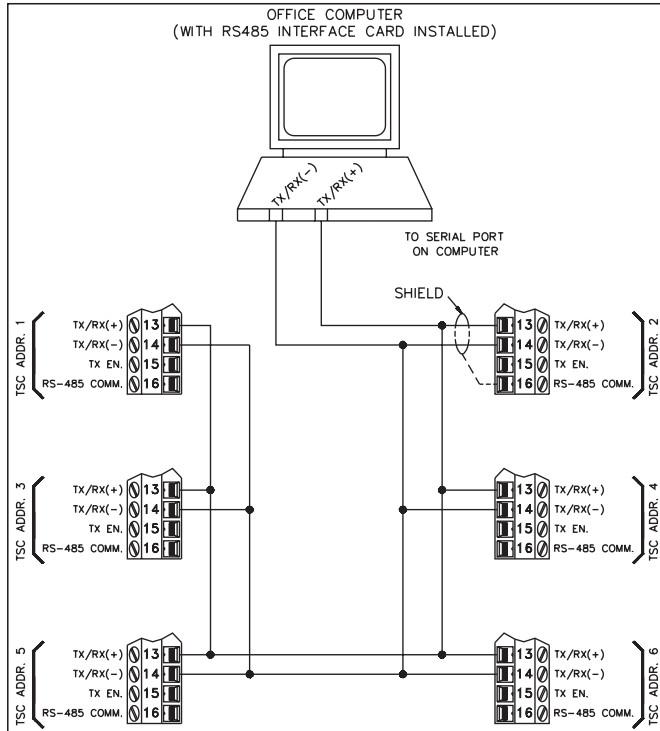

An application program is written to send and receive data from the units using the proper commands.

TROUBLESHOOTING SERIAL COMMUNICATIONS

If problems are encountered when interfacing the TSC(s) and host device or printer, the following check list can be used to help find a solution.

1. Check all wiring. Refer to the previous application examples and use them as a guide to check your serial communication wiring. Proper polarity of all units and other peripherals must be observed.
2. If the TSC is connected to a "host computer", device or printer, check to make sure that the computer or device is configured with the same baud rate and communication format as the TSC. The communication format the TSC will accept is; 1 start bit, 7 data bits, no parity or 1 parity bit (odd or even), and 1 stop bit.
3. Check the TSC's unit address. If the Address command is not used when transmitting a command to the TSC, the TSC's address must be set to 0. See "Sending Commands & Data" section for command structure.
4. If two-way communications are to be established between the TSC and a computer, have the computer receive transmissions from the TSC first. Activating the User Input, programmed for the print request function, will initiate transmissions from the TSC.
5. When sending commands to the TSC, an asterisk * (2Ah) must terminate the command. After system power-up an asterisk must first be sent to clear the TSC input buffer.
6. In multiple unit configurations, make sure each unit has a different address other than zero.
7. If all of the above has been done, try reversing the polarity of the transceiver wires between the TSC(s) and the RS-485 interface card. Some cards have the polarity reversed.

PID CONTROL

PROPORTIONAL BAND

Proportional band is defined as the “band” of temperature the process changes to cause the percent output power to change from 0% to 100%. The band may or may not be centered about the setpoint value depending upon the steady state requirements of the process. The band is shifted by manual offset or integral action (automatic reset) to maintain zero error. Proportional band is expressed as percent of input sensor range.

(Ex. Thermocouple type T with a temperature range of 600°C is used and is indicated in degrees C with a proportional band of 5%. This yields a band of $600^{\circ}\text{C} \times 5\% = 30^{\circ}\text{C}$)

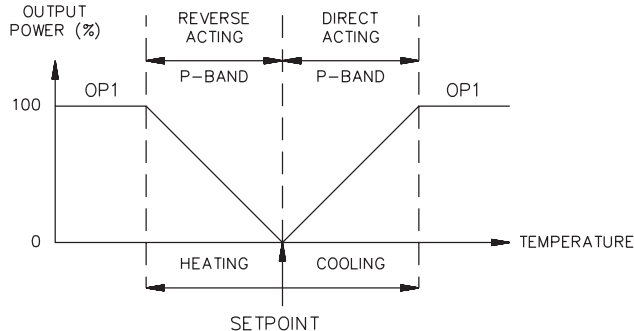

The proportional band should be set to obtain the best response to a disturbance while minimizing overshoot. Low proportional band settings (high gain) result in quick controller response at expense of stability and increased overshoot. Settings that are excessively low will produce continuous oscillations at setpoint. High proportional band settings (low gain) results in a sluggish response with long periods of process “droop”. A proportional band of 0.0% forces the controller into ON/OFF control mode with its characteristic cycling at setpoint (see ON/OFF Control).

INTEGRAL TIME

Integral time is defined as the time, in seconds, in which the output due to integral action alone equals the output due to proportional action with a constant process error. As long as a constant error exists, integral action will “repeat” the proportional action every integral time. Integral action shifts the center point position of the proportional band to eliminate error in the steady state. The units of integral time are seconds per repeat.

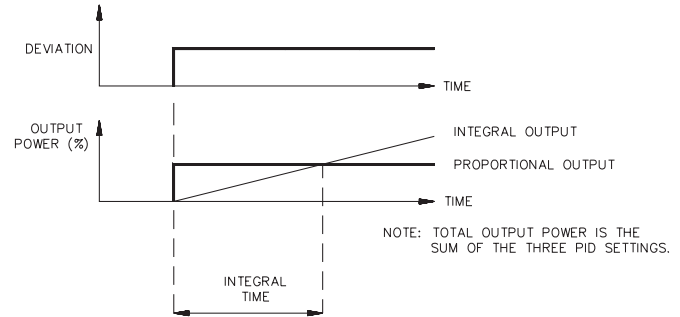

Integral action (also known as “automatic reset”) changes the output power to bring the process to setpoint. Integral times that are too fast (small times) do not allow the process to respond to the new output value and, in effect, “over compensate” which leads to an unstable process with excessive overshoot. Integral times that are too slow (large times) produce a response which is sluggish to eliminate steady state errors. Integral action may be disabled by setting the term to 0. If done so, the previous integral output power value is maintained to keep the output at a constant level.

INTEGRAL TIME (Cont'd)

If integral action is disabled (Automatic Reset), manual reset is available by modifying the output power offset ("OPOF" initially set to zero) to eliminate steady state errors. This parameter appears in unprotected parameter mode when integral time is set to zero. The controller has the feature to prevent integral action when operating outside the proportional band. This prevents "reset wind-up".

Note: The Proportional band shift due to integral action may itself be "reset" by temporarily setting the controller into the ON/OFF control mode (proportional band = 0).

DERIVATIVE TIME

Derivative time is defined as the time, in seconds, in which the output due to proportional action alone equals the output due to derivative action with a ramping process error. As long as ramping error exists, the derivative action will be "repeated" by proportional action every derivative time. The units of derivative time are seconds per repeat.

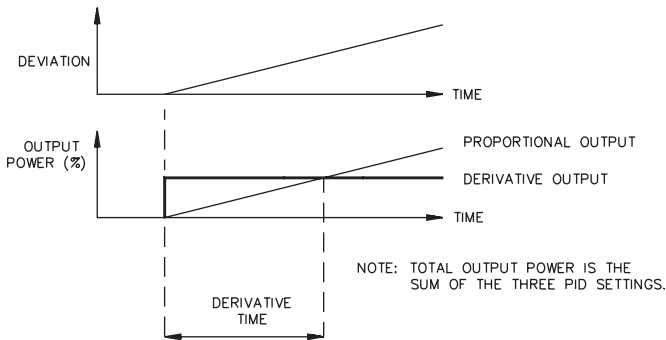

Derivative action is used to shorten the process response time and helps to stabilize the process by providing an output based on the rate of change of the process. In effect, derivative action anticipates where the process is headed and changes the output before it actually "arrives". Increasing the derivative time helps to stabilize the response, but too much derivative time coupled

with noisy signal processes, may cause the output to fluctuate too greatly yielding poor control. None or too little derivative action usually results in decreased stability with higher overshoots. No derivative action usually requires a wider proportional and slower integral times to maintain the same degree of stability as with derivative action. Derivative action is defeated by setting the time to zero.

OUTPUT POWER OFFSET (MANUAL RESET)

If the integral time is set to 0 (automatic reset is off), it may be necessary to modify the output power to eliminate errors in the steady state. The output power offset (OPOF) parameter will appear in the unprotected mode, if the integral time = 0. If integral action (automatic reset) is later invoked, the previous output power offset remains in effect.

PID ADJUSTMENTS

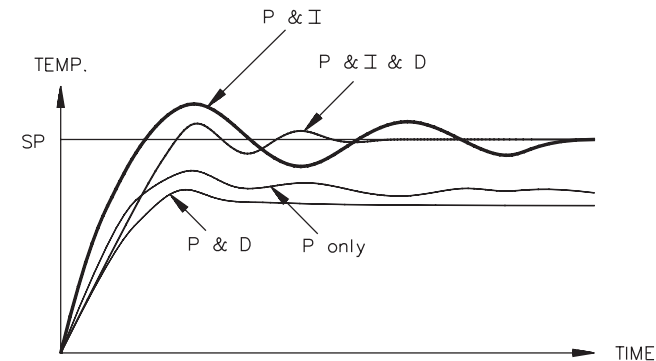

To aid in the adjustment of the PID parameters for improved process control, a temperature chart recorder is necessary to provide a visual means of analyzing the process. Compare the actual process response to the PID response figures with a step change to the process. Make changes to the PID parameters in no more than 20% increments from the starting value and allow the process sufficient time to stabilize before evaluating the effects of the new parameter settings.

PROCESS RESPONSE EXTREMES

OVERSHOOT AND OSCILLATIONS

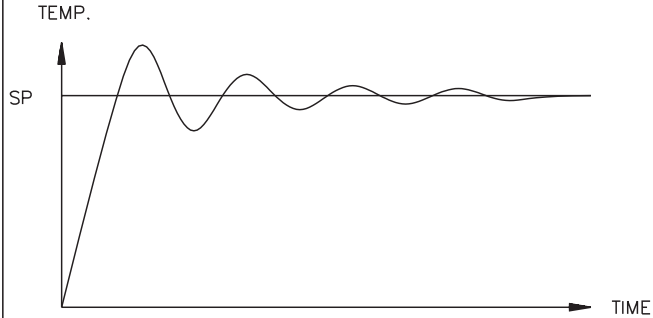

TO DAMPEN RESPONSE:

- INCREASE PROPORTIONAL BAND.
- INCREASE INTEGRAL TIME.
- USE SETPOINT RAMPING.
- USE OUTPUT POWER LIMITS.
- RE-INVOKE AUTO-TUNE WITH A HIGHER DAMPENING CODE.
- INCREASE DERIVATIVE TIME.
- CHECK CYCLE TIME.

SLOW RESPONSE

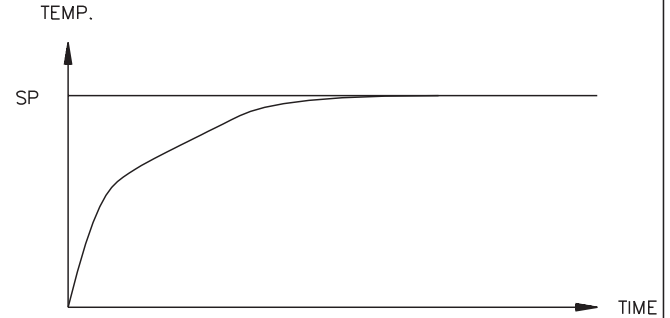

TO QUICKEN RESPONSE:

- DECREASE PROPORTIONAL BAND.
- DECREASE INTEGRAL TIME.
- INCREASE OR DEFEAT SETPOINT RAMPING.
- EXTEND OUTPUT POWER LIMITS.
- RE-INVOKE AUTO-TUNE WITH A LOWER DAMPENING CODE.
- DECREASE DERIVATIVE TIME.

ON/OFF CONTROL

The controller can operate in the ON/OFF control mode by setting the proportional band = 0.0. The ON/OFF control hysteresis band (CHYS) parameter can be used to eliminate output chatter around setpoint. The cooling output can also be used in the ON/OFF control by setting the relative gain = 0.0

The phase of the control action can be reversed by the output control action parameter. ON/OFF control is usually characterized by significant temperature oscillations about the setpoint value. Large control hysteresis values makes the oscillations larger. ON/OFF control should only be used where the constant oscillations have little effect on the process.

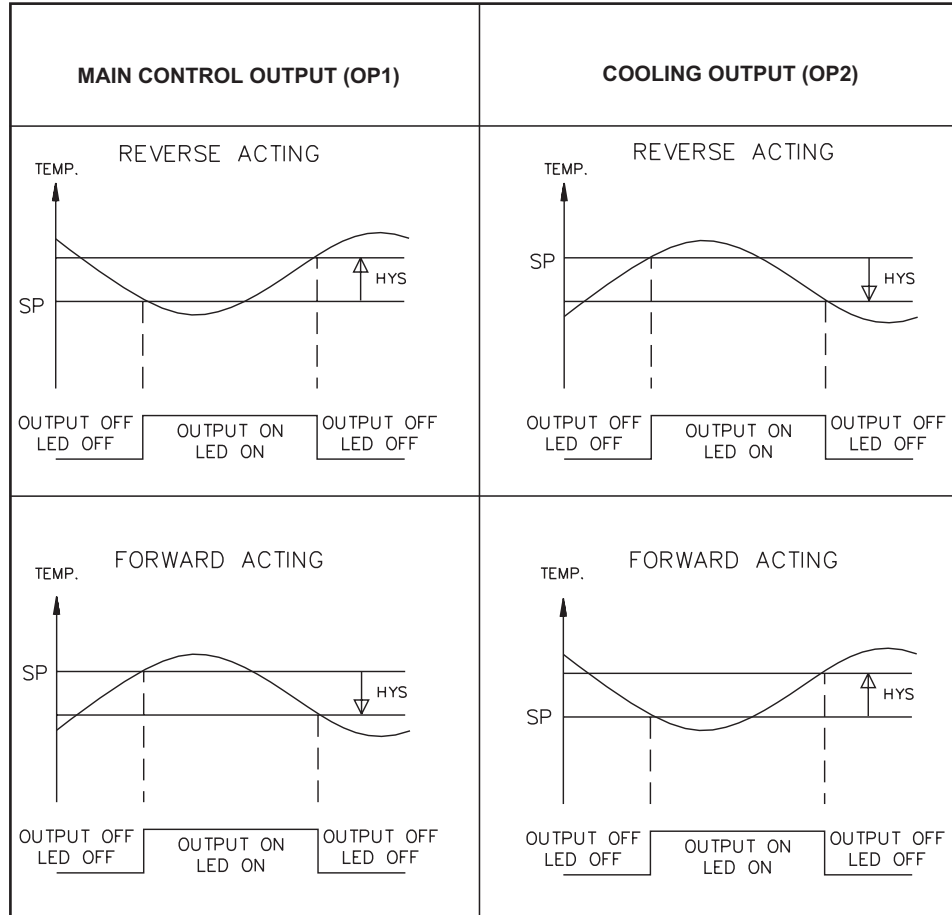

ON/OFF CONTROL

ON/OFF and PID control can be used for the heat and cool output in several combinations. The following lists the valid control modes:

OP1 & OP2 VALID CONTROL MODES				
OP1 MODE	OP2 MODE	MANUAL MODE OUTPUT POWER RANGE	OP1 STATE	OP2 STATE
PID	—	0% to +100.0%	OP1-TP	—
ON/OFF (PrOP=0.0)	—	+100.0%	OP1-ON	—
		Any other setting	OP1-OFF	—
PID	PID	-100.0% to +100.0%	OP1-TP	OP2-TP
PID (GAN2=0.0)	ON/OFF	0% to +100.0%	OP1-TP	OP2-OFF
		-100.0% to 0%	OP1-TP	OP2-ON
ON/OFF (PrOP=0.0)	ON/OFF (GAN2=0.0)	+100.0%	OP1-ON	OP2-OFF
		-100.0%	OP1-OFF	OP2-ON
		Any other settings	OP1-OFF	OP2-OFF
TP - Time Proportioning				
Note: In manual mode, the % output power is not limited to the output power limits (OPLO & OPHI).				

AUTO-TUNE

Auto-Tune is a user initiated function in which the controller automatically determines the optimum PID settings based upon the process characteristics. The desired temperature setpoint should be entered first. Auto-Tune may then be initiated at start-up, from setpoint, or at any other process temperature point. Auto-Tune may be invoked while a profile is running and after Auto-Tune is complete, the profile resumes operation.

After Auto-Tune is complete, the PID settings remain constant until user modified. As shown in the Auto-Tune Operation figure, Auto-Tune cycles the process at a control point 3/4 of the distance between the current process temperature where Auto-Tune was initiated and the temperature setpoint. The 3/4 control point was selected to reduce the chance of temperature overshoot at setpoint when Auto-Tuning at start-up. If Auto-Tuning from setpoint and temperature overshoot is unacceptable, place the controller in the user (manual) mode and reduce the power to lower the process temperature. Allow the temperature to stabilize and execute Auto-Tune from the lower temperature. After starting Auto-Tune, the secondary display indicates the current phase (Aut1, Aut2, Aut3, Aut4, & Aut5). If the controller remains in an Auto-Tune phase unusually long, the process or connections may be faulty. Auto-Tune may be terminated at any time without disturbing the previous PID constants. As an alternative to auto-tuning, the manual tuning procedure can be used to give satisfactory results.

Prior to initiating Auto-Tune, it is essential that the controller be configured to the application. In particular, control hysteresis (CHYS) and Auto-Tune damping code (tcod) must be set in the Output Parameters section. Generally, control hysteresis of 2 - 5 degrees is adequate. The damping code may be set to yield the response characteristics shown in the damping code figure.

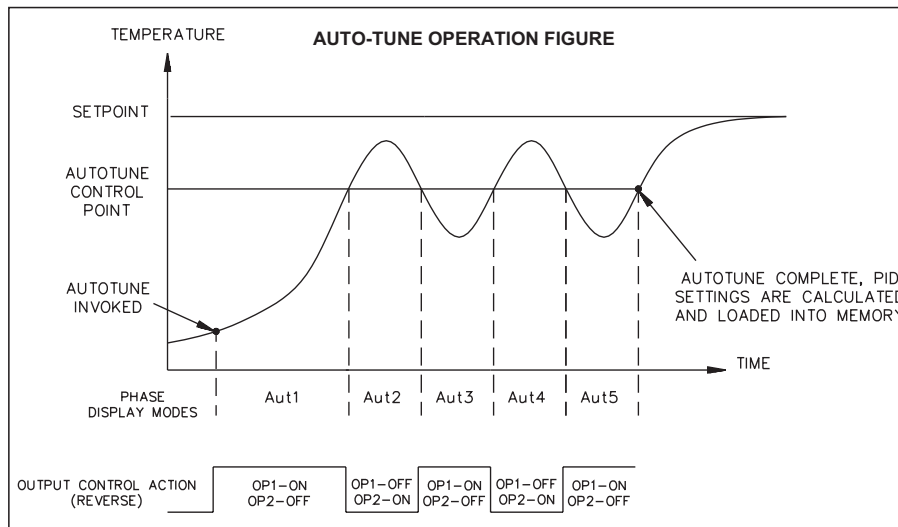

AUTO-TUNE (Cont'd)

A damping code setting of 0 gives the fastest response with some overshoot, and a code of 4 gives the slowest response with minimum overshoot.

For heat/cool systems, use a damping code of 1 or 2. On these systems, the relative cooling gain (Gan2) and heat/cool overlap (db-2) must be set by the user (the controller will not alter these parameters). (See Cooling section for adjustment of these parameters). During Auto-Tune, it is important that external load disturbances be minimized, and if present, other zone controllers idled as these will have an effect on the PID constant determination. Keep in mind for large thermal systems with long time constants, Auto-Tune may take hours to complete.

DAMPING CODE FIGURE

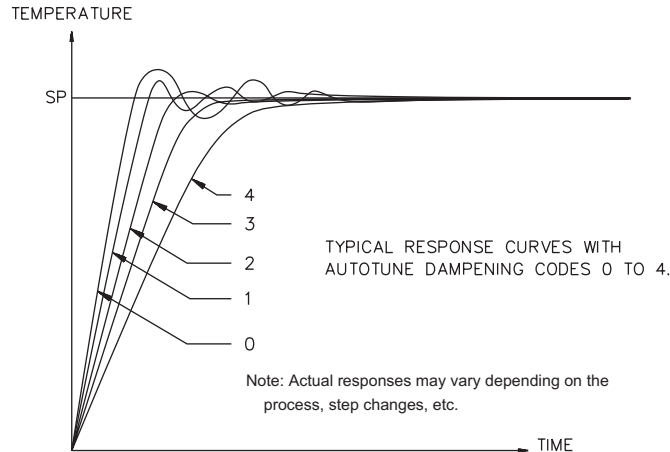

To Initiate Auto-Tune:

Make sure that Auto-Tuning is enabled in parameter lockouts module.
Place the controller into the normal display mode.
Press PAR for 3 seconds from normal display mode.
Scroll to "tUNE" by use of PAR, if necessary.
Select "YES" and press PAR.
Auto-Tune is initiated.

To Cancel Auto-Tune: (Old PID settings remain in effect).

- A) Make sure that Auto-Tuning is enabled in parameter lockouts module.
Place the controller into the normal display mode.
Press PAR for 3 seconds from normal display mode.
Scroll to "tUNE" by use of PAR, if necessary.
Select "NO" and press PAR.
Auto-Tune canceled.
- B) Or reset the controller by disconnecting AC power.

Note: If using the linear DC output for control, full power will be applied (+100% OP1 or -100% OP2) regardless of the output power limit settings.

APPENDIX "A" - APPLICATION EXAMPLE

TSC Glass Tempering Application

A manufacturer of glass items needs to anneal (temper) their products to reduce the brittleness of the glass structure. The tempering process requires the glass to be heated and subsequently cooled at a controlled rate to change the structure of the glass. Different tempering profiles are required for different types of glass products.

A TSC is employed to control the temperature profile of the annealing oven. Four different temperature profiles are stored in the controller. The 4-20 mA analog output option is utilized to cool the annealing oven during the cool down ramp phases. An event output is used to quickly cool the oven at the end of the batch run (alarm 1). Alarm 2 is used to signal the operator whenever the temperature is outside the prescribed profile.

Note: Units equipped with the RS-485 option have different terminal designers. See "Output Variations with or without the RS-485 Option".

The programming for this profile is as follows:

Parameter	Value	Description
"P1r1"	5.0	Ramp from ambient temp. during heat phase at 5.0°/min.
"P1L1"	300	Target setpoint level 300°
"P1H1"	40.0	Heat at 300° for 40.0 minutes
"P1r2"	3.0	Ramp down 3.0°/min. during cooling phase
"P1L2"	150	Target Setpoint is 150°
"P1H2"	0.0	Do not hold at 150° (used as "phantom" hold time for triggering event output for auxiliary cooling)
"P1r3"	-0.1	End Program
"P1 1"	1F2F	Turn off output 1 (output 2 is alarm)
"P1 2"	1F2F	Keep off output 1
"P1 3"	1F2F	Keep off output 1
"P1 4"	1N2F	Turn on output 1 for Auxiliary Exhaust Fan

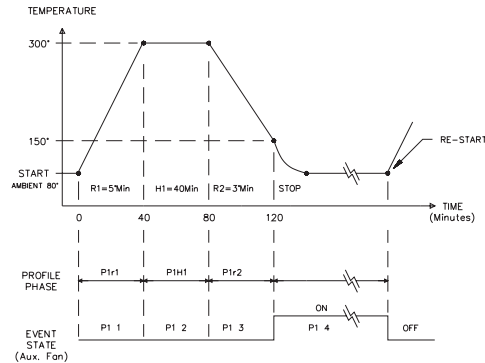
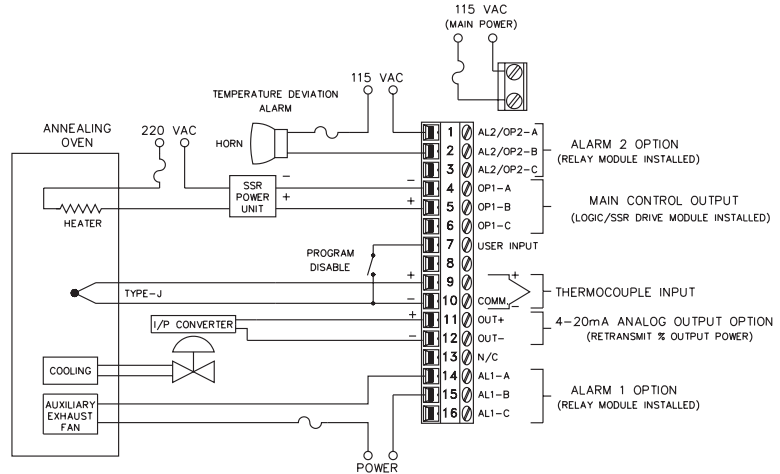

APPENDIX "B" - SPECIFICATIONS AND DIMENSIONS

1. DISPLAY: Dual 4-digit

Upper Temperature Display: 0.4" (10.2 mm) High Red LED

Lower Auxiliary Display: 0.3" (7.6 mm) High Green LED

Display Messages:

- "LOL" - Appears when measurement exceeds + sensor range.
- "ULUL" - Appears when measurement exceeds - sensor range.
- "OPEN" - Appears when open sensor is detected.
- "SHrt" - Appears when shorted sensor is detected (RTD only).
- "...." - Appears when display value exceeds + display range.
- "-..." - Appears when display value exceeds - display range.

2. POWER: Switch selectable 115/230 VAC (+10%, -15%) no observable line variation effect, 48-62 Hz, 10 VA

3. ANNUNCIATORS:

6 LED Backlight Status Indicators:

- %PW - Lower auxiliary display shows power output in (%).
- PGM - Lower auxiliary display shows profile status or profile time remaining.
- MAN - Controller is in manual mode.
- OP1 - Main control output is active.
- AL1 - Alarm #1 is active.
- AL2 - Alarm #2 is active (For dual alarm option).
- OP2 - Cooling output is active (For cooling option).

4. CONTROLS: Four front panel push buttons for setup and modification of controller functions and one external input.

DIMENSIONS In inches (mm)

Note: Recommended minimum clearance (behind the panel) for panel latch installation is 5.5" (140)H x 2.1" (53.4)W.

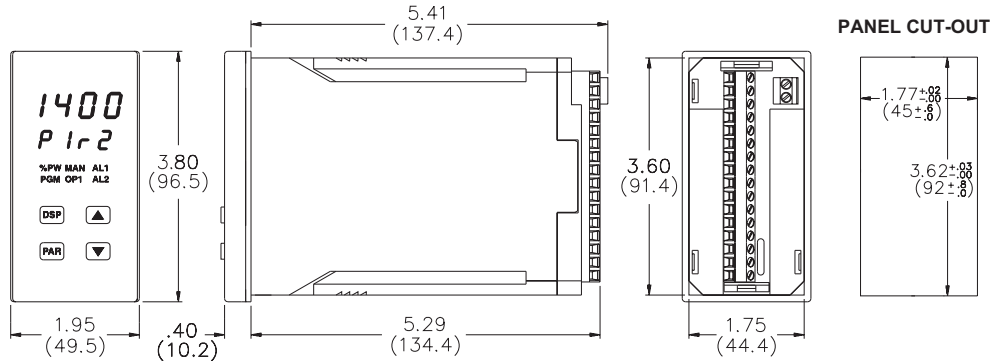

5. SETPOINT PROFILE:

Profiles: 4

Segments Per Profile: 8 ramp/hold segments (*linkable to 32 segments*).

Ramp Rate: 0.1 to 999.9 degrees/minute or step ramp.

Hold Time: Off or from 0.1 to 999.9 minutes, can be extended to 500 hours by linking.

Error Band Conformity: Off or from 1 to 9999 degrees deviation, + value for hold phases, - value for both ramp and hold phases.

Power-On Modes: Stop, auto-start, or profile resume.

Start Mode: Ramps from process temperature.

Program Auto Cycle: 1 to 249, or continuous.

Event Outputs: 2, time activated with profile [uses Alarm output(s)].

Control: Front panel buttons, user input, or RS-485 communications.

6. CONTROL POINTS:

Setpoints: 4

PID gain sets: 4

Control: Front panel buttons or user input.

7. SENSOR INPUT:

Sample Period: 100 msec

Response Time: 300 msec (*to within 99% of final value w/step input; typically, response is limited to response time of probe*).

Failed Sensor Response:

Main Control Output(s): Programmable preset output.

Display: "OPEN".

Alarms: Upscale drive.

DC Linear: Programmable preset output.

Normal Mode Rejection: 40 dB @ 50/60 Hz
(*improves with increased digital filtering*).

Common Mode Rejection: 100 dB, DC to 50/60 Hz.

Protection: Input overload voltage; 240 VAC @ 30 sec max.

8. THERMOCOUPLE:

Types: T, E, J, K, R, S, B, N or Linear mV.

Input Impedance: 20 M Ω , all types.

Lead Resistance Effect: 20 μ V/350 Ω .

Cold Junction Compensation: Less than $\pm 1^{\circ}\text{C}$ error over 0-50 $^{\circ}\text{C}$ ambient temperature range. Disabled for linear mV type.

Resolution: 1 $^{\circ}\text{C}/\text{F}$ all types, or 0.1 $^{\circ}\text{C}/\text{F}$ for T, E, J, K, and N only.

9. RTD: 2, 3 or 4 wire, 100 Ω platinum,
alpha = 0.00385 (DIN 43760),
alpha = 0.003916

Excitation: 0.175 mA

Resolution: 1 or 0.1 degree

Lead Resistance: 7 Ω max.

10. RANGE AND ACCURACY:

Errors include NIST conformity and A/D conversion errors at 23 $^{\circ}\text{C}$ after 20 minutes warm-up. Thermocouple errors include cold junction effect. Errors are expressed as \pm (% of reading) and \pm 3/4 LSD unless otherwise noted.

TC TYPE	RANGE	ACCURACY	WIRE COLOR (ANSI)
T	-200 to +400 $^{\circ}\text{C}$ -328 to +752 $^{\circ}\text{F}$	0.20% + 1.5 $^{\circ}\text{C}$ 0.20% + 2.7 $^{\circ}\text{F}$	blue
E	-200 to +750 $^{\circ}\text{C}$ -328 to +1382 $^{\circ}\text{F}$	0.20% + 1.5 $^{\circ}\text{C}$ 0.20% + 2.7 $^{\circ}\text{F}$	violet
J	-200 to +760 $^{\circ}\text{C}$ -328 to +1400 $^{\circ}\text{F}$	0.15% + 1.5 $^{\circ}\text{C}$ 0.15% + 2.7 $^{\circ}\text{F}$	white
K	-200 to +1250 $^{\circ}\text{C}$ -328 to +2282 $^{\circ}\text{F}$	0.20% + 1.5 $^{\circ}\text{C}$ 0.20% + 2.7 $^{\circ}\text{F}$	yellow
R	0 to +1768 $^{\circ}\text{C}$ +32 to 3214 $^{\circ}\text{F}$	0.15% + 2.5 $^{\circ}\text{C}$ 0.15% + 4.5 $^{\circ}\text{F}$	black
S	0 to +1768 $^{\circ}\text{C}$ +32 to 3214 $^{\circ}\text{F}$	0.15% + 2.5 $^{\circ}\text{C}$ 0.15% + 4.5 $^{\circ}\text{F}$	black
B	+200 to +1820 $^{\circ}\text{C}$ +300 to +3300 $^{\circ}\text{F}$	0.15% + 2.5 $^{\circ}\text{C}$ 0.15% + 4.5 $^{\circ}\text{F}$	grey
N	-200 to +1300 $^{\circ}\text{C}$ -328 to +2372 $^{\circ}\text{F}$	0.20% + 1.5 $^{\circ}\text{C}$ 0.20% + 2.5 $^{\circ}\text{F}$	orange
mV	-5.00 to 56.00	0.15% + 1 LSD	---
RTD (385)	-200 to +600 $^{\circ}\text{C}$ -328 to +1100 $^{\circ}\text{F}$	0.10% + 0.5 $^{\circ}\text{C}$ 0.10% + 0.9 $^{\circ}\text{F}$	---
RTD (392)	-200 to +600 $^{\circ}\text{C}$ -328 to +1100 $^{\circ}\text{F}$	0.10% + 0.5 $^{\circ}\text{C}$ 0.10% + 0.9 $^{\circ}\text{F}$	---
OHMS	1.0 to 320.0	0.15% + 1 LSD	---

APPENDIX “B” - SPECIFICATIONS & DIMENSIONS (Cont’d)

11. OUTPUT MODULES [Optional] (For All Output Channels):

Relay:

Type: Form-C (Form-A with RS-485 option)

Rating: 5 Amps @ 120/240 VAC or 28 VDC (resistive load),
1/8 HP @ 120 VAC (inductive load).

Life Expectancy: 100,000 cycles at maximum rating. (Decreasing load and/or increasing cycle time, increases life expectancy).

Logic/SSR Drive: Can drive up to three SSR Power Units.

Type: Non-isolated switched DC, 12 VDC typical

Drive: 45 mA max.

Protection: Short-circuit protected.

Triac:

Type: Isolated, Zero Crossing Detection.

Ratings:

Voltage: 120/240 VAC

Max Load Current: 1 AMP @ 35°C
0.75 AMP @ 50°C

Min Load Current: 10 mA

Off State Leakage Current: 7 mA max. @ 60 Hz

Operating Frequency: 20 to 500 Hz

Protection: Internal Transient Snubber, Fused.

12. MAIN CONTROL OUTPUT (Heating or Cooling):

Control: PID or ON/OFF.

Output: Time proportioning or linear DC.

Hardware: Plug-in, replaceable output modules.

Cycle time: Programmable.

Auto-Tune: When performed, sets proportional band, integral time, and derivative time values.

Probe Break Action: Programmable.

13. COOLING OUTPUT (Optional):

Control: PID or ON/OFF.

Output: Time proportioning or linear DC.

Hardware: Plug-in, replaceable output modules.

Cycle time: Programmable.

Proportional Gain Adjust: Programmable.

Heat/Cool DeadBand: Programmable.

14. LINEAR DC DRIVE (Optional): With digital scale and offset, programmable deadband and update time.

4-20 mA:

Resolution: 1 part in 3500 typical

Accuracy: $\pm(0.1\%$ of reading + 25 μ A)

Compliance: 10 V (500 Ω max. loop impedance)

0 to 10 VDC:

Resolution: 1 part in 3500 typical

Accuracy: $\pm(0.1\%$ of reading + 35 mV)

Min Load Resistance: 10 K Ω (1 mA max.)

Source: % output power, setpoint, deviation, or temperature.

(Available for heat or cool, but not both.)

15. ALARMS (Optional):

Hardware: Plug-in, replaceable output module.

Modes: Absolute high acting
Absolute low acting
Deviation high acting
Deviation low acting
Inside band acting
Outside band acting
Timed event output(s)

Reset Action: Programmable; automatic or latched.

Delay: Programmable; enable or disable.

Hysteresis: Programmable.

Probe Break Action: Upscale.

Annunciator: LED backlight for “AL1”, “AL2”, (Alarm #2 not available with cooling output).

16. SERIAL COMMUNICATIONS (Optional):

Type: RS-485 Multi-point, Balanced Interface.

Communication Format:

Baud Rate: Programmable from 300 to 9600.

Parity: Programmable for odd, even, or no parity.

Frame: 1 start bit, 7 data bits, 1 or no parity bit, 1 stop bit.

Unit Address: Programmable from 0-99, maximum of 32 units per line.

Transmit Delay: 100 msec Minimum, 200 msec Maximum.

RS-485 Common: Isolated from signal input common.

Auto Print Time: Off to 9999 seconds between print-outs.

17. USER INPUT: Internally pulled to +5 VDC; V_{IN} Max = 5.25 VDC, $V_{IL} = 0.85 V_{MAX}$; $V_{IH} = 2.0 V_{MIN}$, Response time 100 msec maximum.

Functions:

Program Lock	Print Request
Integral Action Lock	Load Control Point
Auto/Manual Transfer	Run/Hold Profile 1
Setpoint Ramp Select	Run/Stop Profile 1
Reset Alarms	

18. ENVIRONMENTAL CONDITIONS:

Operating Temperature: 0° to 50°C
Storage Temperature: -40° to 80°C
Operating and Storage Humidity: 85% max. Relative humidity (non-condensing) from 0 to 50°C.
Span Drift: ≤ 100 ppm/°C
Zero Drift: $\leq 1\mu$ V/°C
Altitude: Up to 2000 meters

19. CERTIFICATIONS AND COMPLIANCES:

SAFETY

UL Listed, File # E137808, UL508, CSA C22.2 No. 14-M95 LISTED by Und. Lab. Inc. to U.S. and Canadian safety standards
UL Recognized Component, File # E156876, UL873, CSA C22.2 No. 24 Recognized to U.S. and Canadian requirements under the Component Recognition Program of Underwriters Laboratories, Inc.
Type 2 or 4X Enclosure rating (Face only), UL50
IECEE CB Scheme Test Certificate # UL1239-156876/USA, CB Scheme Test Report # 96ME50279-070794
Issued by Underwriters Laboratories, Inc.
IEC 1010-1, EN 61010-1: Safety requirements for electrical equipment for measurement, control, and laboratory use, Part 1.
IP65 Enclosure rating (Face only), IEC 529

ELECTROMAGNETIC COMPATIBILITY

Immunity to EN 50082-2

Electrostatic discharge	EN 61000-4-2	Level 2; 4 Kv contact Level 3; 8 Kv air
Electromagnetic RF fields	EN 61000-4-3	Level 3; 10 V/m ¹ 80 MHz - 1 GHz
Fast transients (burst)	EN 61000-4-4	Level 4; 2 Kv I/O Level 3; 2 Kv power
RF conducted interference	EN 61000-4-6	Level 3; 10 V/rms ² 150 KHz - 80 MHz

Emissions to EN 50081-2

RF interference	EN 55011	Enclosure class A Power mains class A
-----------------	----------	--

Notes:

- 1. Self-recoverable loss of performance during EMI disturbance at 10 V/m: Analog output signal may deviate during EMI disturbance.
For operation without loss of performance:
Install 1 ferrite core 1 turn, RLC #FCOR0000 or equivalent, to power lines at unit.

or
Install power line filter, RLC #LFIL0000 or equivalent.*
- 2. Self-recoverable loss of performance during EMI disturbance at 10 Vrms: Analog output signal may deviate during EMI disturbance.
For operation without loss of performance:
a. Install 1 ferrite core 1 turn, RLC #FCOR0000 or equivalent, to power lines at unit.

or
Install power line filter, RLC #LFIL0000 or equivalent.
b. Install 1 ferrite core 1 turn, RLC #FCOR0000 or equivalent, to analog output cable at unit.*

Refer to the EMC Installation Guidelines section of the manual for additional information.

20. CONNECTION: Jaw-type terminal block.

Wire Range: 12-30 AWG copper wire

Torque: 5-7 inch-lbs (56-79 N-cm)

21. CONSTRUCTION:

Front Panel: Flame and scratch resistant tinted plastic.

Case: High impact black plastic. (Mounting collar included).

NEMA 4X/IP65 model only: Sealed bezel utilizing 2 captive mounting screws (panel gasket included). This unit is rated for NEMA 4X/IP65 indoor use. Installation Category II, Pollution Degree 2.

22. WEIGHT: 1.3 lbs. (0.6 kgs)

APPENDIX “C” - TROUBLESHOOTING

The majority of problems can be traced to improper connections or incorrect set-up parameters. Be sure all connections are clean and tight, that the correct output module is fitted, and that the set-up parameters are correct. For further technical assistance, contact technical support at the numbers listed on the back cover of the instruction manual.

PROBLEMS	POSSIBLE CAUSE	REMEDIES
NO DISPLAY	<ol style="list-style-type: none"> 1. Power off 2. Voltage selector switch in the wrong position. 3. Brown out condition 4. Loose connection or improperly wired. 5. Bezel assembly not fully seated into rear of unit. 	<ol style="list-style-type: none"> 1. Check power. 2. Check selector switch position. 3. Verify power reading. 4. Check connections. 5. Check installation.
INDICATOR NOT WORKING	<ol style="list-style-type: none"> 1. Incorrect parameter set-up 	<ol style="list-style-type: none"> 1. Check set-up parameters. <ol style="list-style-type: none"> a. Power-up unit for self-test.
“E-FP” IN DISPLAY	<ol style="list-style-type: none"> 1. Defective front panel button. 	<ol style="list-style-type: none"> 1. Press DSP to escape, then check all buttons for proper operation. 2. Replace unit.
“E-UP” IN DISPLAY	<ol style="list-style-type: none"> 1. Internal problem with controller. 	<ol style="list-style-type: none"> 1. Replace unit.
“E-E2” IN DISPLAY	<ol style="list-style-type: none"> 1. Loss of set-up parameters due to noise spike. 	<ol style="list-style-type: none"> 1. Press DSP to clear then check ALL set-up parameters. <ol style="list-style-type: none"> a. Check sensor input & AC line for excessive noise. b. If fault persists, replace unit.
“E-CJ” FLASHING IN UPPER DISPLAY	<ol style="list-style-type: none"> 1. Input jumper set for RTD and input programming set for thermocouple. 	<ol style="list-style-type: none"> 1. Check input jumper position.
“...” or “-...” IN DISPLAY	<ol style="list-style-type: none"> 1. Temperature over 999.9 or under -99.9. 2. Defective or mis-calibrated cold junction circuit. 3. Loss of set-up parameters. 4. Internal malfunction. 	<ol style="list-style-type: none"> 1. Change to 1° resolution. <ol style="list-style-type: none"> a. Verify temperature reading. 2. Check cold junction calibration. 3. Check set-up parameters. 4. Check calibration.

APPENDIX “C” - TROUBLESHOOTING (Cont’d)

PROBLEMS	POSSIBLE CAUSE	REMEDIES
“OPEN” IN DISPLAY	<ol style="list-style-type: none"> 1. Probe disconnected. 2. Input selector jumper in wrong position. 3. Broken or burned out probe. 4. Corroded or broken terminations. 5. Excessive process temperature. 	<ol style="list-style-type: none"> 1. Connect probe. 2. Verify correct jumper position. 3. Replace probe. 4. Check connections. 5. Check process parameters.
“LOL” IN DISPLAY	<ol style="list-style-type: none"> 1. Temperature exceeds range of input probe. 2. Excessive positive probe temperature. 3. Loss of set-up parameters. 	<ol style="list-style-type: none"> 1. Change to input sensor with a higher temperature range. 2. Reduce temperature. 3. Check set-up.
“ULUL” IN DISPLAY	<ol style="list-style-type: none"> 1. Temperature below range of input probe. 2. Excessive negative probe temperature. 3. Loss of set-up parameters. 	<ol style="list-style-type: none"> 1. Change to input sensor with lower bottom range. 2. Increase temperature. 3. Check set-up parameters.
“SHrt” IN DISPLAY	<ol style="list-style-type: none"> 1. RTD probe shorted. 	<ol style="list-style-type: none"> 1. Check wiring. 2. Replace RTD probe.
DISPLAY INCORRECT OR DISPLAY WANDERS	<ol style="list-style-type: none"> 1. Incorrect probe. 2. Connections reversed. 3. Loose or corroded connections. 4. Wrong thermocouple extension wire. 5. Failing or failed probe. 6. Probe placed in unsuitable location or insulated from actual process temperature. 7. Controller needs calibration. 	<ol style="list-style-type: none"> 1. Verify that input type selector and programming agree. 2. Check connections. 3. Check connections. 4. Check extension wire. 5. Check or replace probe. 6. Evaluate probe placement. <ol style="list-style-type: none"> a. Increase digital input filtering. 7. Check calibration. (see Appendix “E” Calibration Accuracy)

APPENDIX “C” - TROUBLESHOOTING (Cont’d)

PROBLEMS	POSSIBLE CAUSE	REMEDIES
TEMPERATURE NOT STABLE OR SLUGGISH	<ol style="list-style-type: none"> 1. Incorrect PID values. 2. Heater undersized. 3. Improper probe location. 	<ol style="list-style-type: none"> 1. See PID CONTROL. 2. Increase heating power. 3. Evaluate probe location.
OUTPUTS NOT WORKING	<ol style="list-style-type: none"> 1. Improperly wired. 2. Incorrect output module. 3. Defective output module. 	<ol style="list-style-type: none"> 1. Check wiring. 2. Check output module. 3. Check or replace output module.
LINEAR DC OUTPUT NOT WORKING	<ol style="list-style-type: none"> 1. Too high load resistance. 2. Incorrect programming or scaling. 3. Connections reversed. 4. DC voltage source in loop. 	<ol style="list-style-type: none"> 1. Check that maximum load resistance is < 500 Ω (10 V). 2. Check programming. 3. Check connections. 4. This is an active loop. Remove all DC voltage sources.
CONTROLLER LOCKS UP OR RESETS	<ol style="list-style-type: none"> 1. Noise spikes entering controller due to load switching transients. 2. Defective controller. 	<ol style="list-style-type: none"> 1. a. Use Triac output module, if possible. b. Use RC snubbers or similar noise suppressors at load point. (Do NOT use at the controller.) c. Use separate AC feed line to controller. d. Locate controller & signal lines away from noise producing mechanisms (solenoids, transformers, relays, etc.). e. See “Installation Considerations Of Electronic Instruments Controls In Industrial Environments” in RLC catalog. 2. Replace unit.

OUTPUT LEAKAGE CURRENT

The AL1 and AL2/OP2 outputs of the TSC have an RC Network (Snubber) on the Normally Open contacts. High energy noise spikes are generated whenever current through an inductive load (such as motors, solenoids or relay coils) is interrupted. This noise may interfere with the unit doing the switching and other nearby equipment causing erratic operation and accelerate relay contact wear.

The Snubber Network is specifically designed with a capacitor and resistor connected in series and installed across relay contacts. The network will have a small amount of AC leakage current even when the TSC's Relay Module is "off". The leakage current is 2.1 mA nominal at a line voltage of 120 VAC, and 4.3 mA nominal at 240 VAC respectively. Leakage current may cause some loads to stay on or to turn on when the Relay Module is turned off. This would only occur in unusual applications (such as with a relay with unusually low holding current or an LED). The leakage current may be eliminated by disabling the snubber, however, doing so will degrade the EMC performance of the unit.

First determine which output is associated with the leakage current: either AL1 or AL2/OP2. Remove the Bezel Assembly from the case (see Removing Bezel Assembly, page 9). The snubbers are located on the Option PCB (on the right side of the unit when viewed from the front). The snubbers consist of a capacitor and a resistor. The two resistors are located along the upper rear edge of the Option PCB. They are green in color and have color code stripes of yellow, violet, black and gold. There will be markings on the PCB close to the resistors that say "SNUB1" and "SNUB2" for AL1 and AL2/OP2 respectively. Using a pair of diagonal cutters, cut both leads of the appropriate resistor and remove it from the unit. Be sure to remove the resistor for only the problem alarm channel; leave the other channel's snubber functional in case it is needed.

The above stated leakage currents are valid when using the Relay Module (OMD00000). The Triac Module (OMD00001) has its own built in snubber and will introduce additional leakage current into the circuit. The Triac Module has leakage current of 2.1 mA nominal at a line voltage of 120 VAC, and 4.3 mA nominal at 240 VAC.

Note: The Snubber Network will be in one of the two configurations shown at right, depending on model ordered.

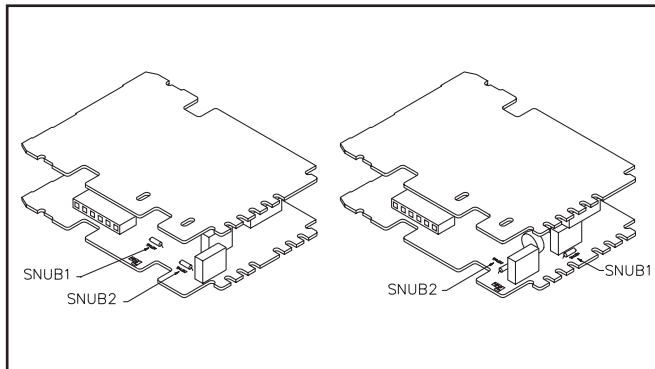

APPENDIX "D" - MANUAL TUNING

OPEN LOOP STEP RESPONSE METHOD

The Open Loop Step Response Method is a tuning procedure that does not induce process oscillations. This method involves making a step change to the process and observing the process reaction. A strip paper recorder or other high resolution data logging equipment is required for this procedure. This procedure requires that all disturbances to the process are minimized because the data is influenced by these disturbances.

- 1) Connect a chart recorder to log temperature and set the paper speed appropriate for the process.
- 2) Set the controller to manual (user) control mode.
- 3) Allow the process to stabilize (line out).
- 4) Make a step change of 10% or more in the controller output. It may be necessary to increase the size of the step to yield a sufficient process reaction curve.
- 5) Record the response of the process. Use the information from the table to calculate the controller tuning values. The PID tuning parameters are determined graphically from the Process Reaction Curve Figure. Draw a vertical line at the moment the step change was made. Draw a line (labeled tangent) through the process reaction curve at its maximum upward slope. Extend this line to intersect the vertical line. Extend this line to intersect the vertical line.

Example: From the Process reaction Curve

$a = 30^\circ$, $t = 300$ sec, step = 10%, thermocouple range = 1700°F .

For fast response:

Prop = 35.3%
 Intt = 900 sec
 dert = 120 sec
 OPdP = 15

Parameter	Fast Response	Damped Response	Slow Response
Proportional Band (%)	$\frac{20000a}{\text{Range} \times \text{Step\%}}$ 3t	$\frac{40000a}{\text{Range} \times \text{Step\%}}$ 4t	$\frac{60000a}{\text{Range} \times \text{Step\%}}$ 5t
Integral Time (Sec)	3t	4t	5t
Derivative Time (Sec)	0.4t	0.4t	0.4t
Output Power Dampening (Sec)	t/20	t/15	t/10

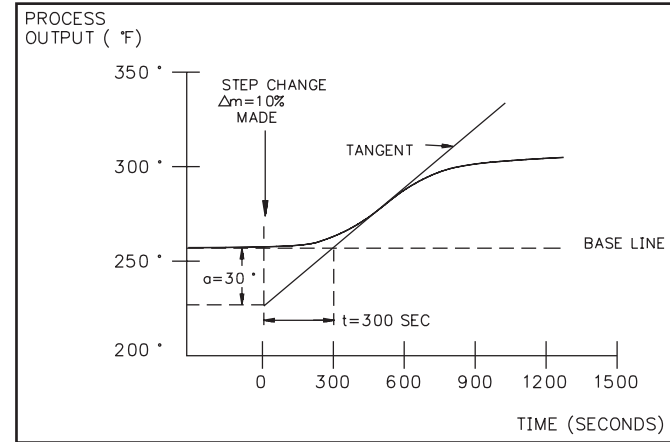

Process Reaction Curve

CLOSED LOOP CYCLING METHOD

An alternative to auto-tuning is manual tuning. This tuning method induces oscillations into the process in the same way as the controller's auto-tune function. If oscillations are not acceptable, the open-loop tuning method can be used.

The following is a manual tuning procedure for determination of the PID control constants.

1. Connect a chart recorder to log temperature and set the paper speed appropriate for the process.
2. Set the controller to automatic (auto) control mode.
3. Set proportional band to 999.9%. (maximum setting)
4. Set integral time and derivative time to 0 seconds.
5. Decrease proportional band (increase controller gain) by factors of two until process just begins to oscillate and the oscillations are sustained. Make a small change in setpoint to provide a stimulus for oscillations. Allow adequate time for the process to respond. If oscillations appear to grow, increase proportional band. Adjust the proportional band until steady oscillations appear.
6. Note the peak-to-peak amplitude of the cycle (a) in degrees and the period of oscillation (t) in seconds.

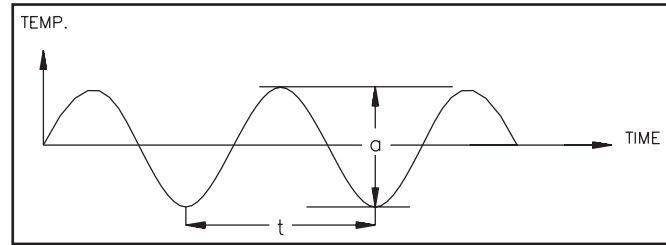

Closed Loop Tuning

Parameter	Fast Response	Damped Response	Slow Response
Proportional Band (%)	200a/range	400a/range	600a/range
Integral Time (sec)	1t	2t	3t
Derivative Time (sec)	0.2t	0.25t	0.25t
Output Power Dampening (sec)	t/40	t/30	t/20

APPENDIX “E” - CALIBRATION

Calibration Check

The instrument has been fully calibrated at the factory for ALL thermocouple and RTD types. If the unit appears to be indicating or controlling incorrectly, refer to the troubleshooting section before attempting this procedure.

If the controller is suspected of reading incorrectly, the instrument may be checked for indication accuracy without disturbing the factory calibration. The four parameters to be checked are: mV reading, thermocouple cold junction temperature, RTD ohms reading, and linear DC output. The following procedures are used for this purpose.

Note: Allow 1/2 hour warm-up with the controller in an upright position in such a manner to allow adequate ventilation to the case before checking these parameters.

mV Reading Check

- 1) Place the input sensor selection jumper in the TC position.
- 2) Connect a DC mV source with an accuracy of 0.01% or better to terminal #9 (+) & #10 (-).
- 3) Select the controller to indicate linear mV (LIN), in configure input parameters.
- 4) Compare the controller readout to the standard at various points over the range (-5.00 mV to 54.00 mV).
The tolerance is 0.15% of reading \pm 1 LSD
- 5) Calibrate the controller if the readings are out of tolerance.

Thermocouple Cold Junction Temperature Check

- 1) Place the input sensor selection jumper in the TC position.
- 2) Place a reference temperature probe in immediate vicinity of terminal #9 & #10.
- 3) Install a shorting wire to terminals #9 & #10.
- 4) With thermocouple type T selected, compare controller readout with a calibrated probe. Allow sufficient time for temperatures to equalize. The tolerance is \pm 1°C.
- 5) Calibrate the cold junction temperature if out of tolerance.

RTD Ohms Reading

- 1) Place the input sensor jumper in the RTD position.
- 2) Connect RTD simulator to terminals #8, #9, & #10 (with an accuracy of 0.1 ohm or better).
- 3) Select the controller for linear OHMS (rLIN) readout, in configure input parameters.
- 4) Compare the controller readout with the RTD simulator at various points over the range 0.0 to 300.0 ohms.
The tolerance is 0.15% of reading \pm 1 LSD.
- 5) Calibrate the controller RTD ohms if out of tolerance.

Linear DC Output Check

- 4 to 20 mA
- 1) Connect an ammeter to the linear output (#11 & #12) with an accuracy of 0.1% or better.
 - 2) Set “ANAS” (analog assignment) to “INP”, in configure input parameters.
 - 3) Drive the input signal level below the programmed “ANLO” value.
Check for 4 mA (\pm 0.02 mA).
 - 4) Drive the input signal level above the programmed “ANHI” value.
Check for 20 mA (\pm 0.03 mA).
 - 5) Calibrate the controller linear DC output if out of tolerance.

0 to 10 VDC

- 1) Connect a voltmeter to the linear output (#11 & #12).
- 2) Set “ANAS” (Analog Assignment) to “INP”, in Configure Input Parameters.
- 3) Drive the input signal level below the programmed “ANLO” value.
Check for 0 VDC (\pm 20 mV).
- 4) Drive the input signal level above the programmed “ANHI” value.
Check for 10 VDC (\pm 30 mV).
- 5) Calibrate the controller linear DC output if out of tolerance.

CALIBRATION

When calibration is required (generally every two years), this procedure should only be performed by qualified technicians using appropriate equipment. Equipment source accuracies of 0.01% or better are required.

The procedure consists of four parts: applying accurate mV signals, setting the thermocouple cold junction temperature, applying precision resistances and measuring accurate mA currents. Allow a 30 minute warm-up period before starting this procedure. Do not use thermocouple wire at any stage of calibration.

This procedure may be aborted by disconnecting power to the controller before exiting the configuration mode. The existing calibration settings remain in affect.

Note: After completing any of the calibration sequences, the controller will default the input sensor type to thermocouple type "j" (tc-j). Be sure to set input sensor for proper type.

Configure Step 9 - Factory Service Operations (9-FS)

Display	Parameter		Description/Comments
Code	Enter factory service function code	48	Calibrate instrument
CAL	Millivolt calibration	yes/no	Calibration required for both RTD and TC input. If this procedure is performed the cold junction temp. and RTD ohms calibration procedures in turn must be completed.
CJC	Thermocouple cold junction temperature calibration	yes/no	Not required if only using RTD input. This procedure can only be performed AFTER an accurate mV calibration.
rtd	RTD resistance calibration	yes/no	Not required if only using TC input. This procedure can only be performed AFTER an accurate mV calibration.
ANCL	analog output	yes/no	This parameter does not appear if analog output option is not installed.

Millivolt Calibration (CAL)

Connect precision millivolt source with an accuracy of 0.01% to terminals (+) #9 and (-) #10.

Display	Parameter	Description/Comments
StP1	0.0 mV step	Apply 0.0 mV, wait 10 seconds, press PAR
StP2	9.0 mV step	Apply 9.0 mV, wait 10 seconds, press PAR
StP3	18.0 mV step	Apply 18.0 mV, wait 10 seconds, press PAR
StP4	27.0 mV step	Apply 27.0 mV, wait 10 seconds, press PAR
StP5	36.0 mV step	Apply 36.0 mV, wait 10 seconds, press PAR
StP6	45.0 mV step	Apply 45.0 mV, wait 10 seconds, press PAR
StP7	54.0 mV step	Apply 54.0 mV, wait 10 seconds, press PAR
Stp-	Pause	The controller imposes a 5 second delay. (Keep the 54mV signal applied) The unit advances to CJC - NO.

Thermocouple Cold Junction Calibration (CJC)

This procedure must be performed AFTER an accurate mV calibration. Place the internal input sensor selection jumper to “TC” position. Place precision thermometer (accuracy of 0.1C) in the immediate vicinity of terminals #9 and #10.

Display	Parameter	Description/Comments
CJ F	Cold junction	Allow 5 minutes for temperatures to equalize.
CJ C	temperature	Observe indicated cold junction temperature and compare with precision thermometer. If equal press PAR. If not equal, directly key-in the correct cold junction temperature. Press PAR.

RTD Ohms Calibration(rtd)

This procedure must be performed AFTER an accurate mV calibration. Place the internal input sensor selection jumper to “RTD” position. Connect one leg of precision resistance (accuracy of 0.1 ohm) to terminals #8 and #9 together, and other leg to #10.

Display	Parameter	Description/Comments
Rtd1	0.0 ohms step	Connect 0.0 ohms resistance (jumper wire), wait ten seconds, press PAR.
Rtd2	277.0 ohms step	Connect 277.0 ohm resistance, wait ten seconds, press PAR.

Analog Output Calibration (ANCL)

4 to 20 mA

Press PAR until ANCL appears in the display. Connect precision ammeter (0.1% accuracy) to rear terminals (+) #11 and (-) #12.

Display	Parameter	Description/Comments
ANC1	Analog output 4 mA code value	Observe current reading. If 4.00 mA, press PAR. If not equal, modify existing code value using up and down buttons to achieve 4.00 mA. Press PAR.
ANC2	Analog output 20 mA code value	Observe current reading. If 20.00 mA, Press PAR. If not equal, modify existing code value using up and down buttons to achieve 20.00 mA. Press PAR.

Analog Output Calibration (ANCL) (Cont'd)

0 to 10 VDC

Press PAR until ANCL appears in the display. Connect a precision voltmeter (0.1% accuracy) to rear terminals (+) #11 and (-) #12.

Display	Parameter	Description/Comments
ANC1	Analog output 0 VDC code value	Observe voltage reading. If 0.00 VDC, press PAR. If not equal, modify existing code value using up and down buttons to achieve 0.00 VDC. Press PAR.
ANC2	Analog output 10 VDC code value	Observe voltage reading. If 10.00 VDC, Press PAR. If not equal, modify existing code value using up and down buttons to achieve 10.00 VDC. Press PAR.

APPENDIX "F" - USER PARAMETER VALUE CHART

Unit Number _____

Mnemonic	Parameter	User Setting
SP	Temperature Setpoint	_____
OPOF	Output Power Offset	_____
OP	Output Power	_____
ProP	Proportional Band	_____
InIt	Integral Time	_____
dErT	Derivative Time	_____
AL-1	Alarm 1	_____
AL-2	Alarm 2	_____

Configure Input

tYPE	Input Sensor Type	_____
SCAL	Temperature Scale Units	_____
dCPt	Temperature Resolution	_____
FLtr	Digital Filtering	_____
SPAN	Input Slope	_____
SHFt	Input Offset	_____
SPLO	Setpoint Lower Limit	_____
SPHI	Setpoint Upper Limit	_____
SPrP	Auto Ramp Rate	_____
InPt	User Input	_____

Configure Output

CYct	Cycle Time	_____
OPAC	Control Action	_____
OPLO	Output Power Lower Limit Range	_____
OPHI	Output Power Upper Limit Range	_____
OPFL	Sensor Fail Power Preset	_____
CHYS	ON/OFF Control Hysteresis	_____
tcod	Auto-Tune Damping Code	_____
ANAS	Linear Output Assignment	_____
ANLO	Linear Output Scale Value	_____
ANHI	Linear Output Scale Value	_____

Configure Lockouts

Mnemonic	Parameter	User Setting
SP	Access Setpoint	_____
OP	Access Output Power	_____
P-cs	Access Profile Status	_____
P-tr	Access Time Remaining	_____
UdSP	Access Display Units	_____
Code	Access Code Number	_____
PID	Access PID Values	_____
AL	Access Alarm(s) Values	_____
ALrS	Enable Reset Alarm(s)	_____
CPAC	Enable Control Points	_____
PrAC	Enable Profile Status	_____
trnF	Enable Auto/Man Transfer	_____
tUNE	Enable Auto-Tune	_____

Configure Alarms

Act1	Alarm 1 Operation Mode	_____
rSt1	Alarm 1 Reset Mode	_____
Stb1	Alarm 1 Standby Enabled	_____
AL-1	Alarm 1 Value	_____
Act2	Alarm 2 Operation Mode	_____
rSt2	Alarm 2 Reset Mode	_____
Stb2	Alarm 2 Standby Enabled	_____
AL-1	Alarm 2 Value	_____
AHYS	Alarm Hysteresis Value	_____

Configure Cooling

CYC2	OP2 Output Cycle Time	_____
GAN2	Relative Cooling Gain	_____
db-2	Heat-Cool Overlap/Deadband	_____

Configure Serial Communications

Mnemonic	Parameter	User Setting
bAUd	Baud Rate	_____
PARb	Parity Bit	_____
Addr	Unit Address	_____
Abrv	Abbrev. or Full Transmission	_____
PrAt	Automatic Print Rate	_____
PoPt	Print Options	_____
	INP	_____
	SEt	_____
	OPr	_____
	Pdb	_____
	INt	_____
	dEr	_____
	AL1	_____
	AL2	_____
	dEv	_____
	OFF	_____
	r P	_____
	Crg	_____
	Cdb	_____
	P-t	_____
	P-s	_____

APPENDIX “F” - USER PARAMETER VALUE CHART (Cont’d)

Configure Control Points

Mnemonic	Parameter	User Setting			
		CP-1	CP-2	CP-3	CP-4
SP	Setpoint Value	_____	_____	_____	_____
PID	YES/NO Load With Setpoint Value	_____	_____	_____	_____
Pb	Proportional Band	_____	_____	_____	_____
It	Integral Time	_____	_____	_____	_____
dt	Derivative Time	_____	_____	_____	_____

Mnemonic	Parameter	User Setting			
		Pr-1	Pr-2	Pr-3	Pr-4
PnH6	Profile Hold Time 6	_____	_____	_____	_____
Pnr7	Profile Ramp Rate 7	_____	_____	_____	_____
Pnl7	Profile Setpoint Level 7	_____	_____	_____	_____
PnH7	Profile Hold Time 7	_____	_____	_____	_____
Pnr8	Profile Ramp Rate 8	_____	_____	_____	_____
Pnl8	Profile Setpoint Level 8	_____	_____	_____	_____
PnH8	Profile Hold Time 8	_____	_____	_____	_____

Configure Profiles

Mnemonic	Parameter	User Setting			
		Pr-1	Pr-2	Pr-3	Pr-4
PnCC	Profile Cycle Count	_____	_____	_____	_____
PnlN	Profile Link	_____	_____	_____	_____
PnSt	Profile Status	_____	_____	_____	_____
PnEb	Profile Error Band	_____	_____	_____	_____
Pnr1	Profile Ramp Rate 1	_____	_____	_____	_____
Pnl1	Profile Setpoint Level 1	_____	_____	_____	_____
PnH1	Profile Hold Time 1	_____	_____	_____	_____
Pnr2	Profile Ramp Rate 2	_____	_____	_____	_____
Pnl2	Profile Setpoint Level 2	_____	_____	_____	_____
PnH2	Profile Hold Time 2	_____	_____	_____	_____
Pnr3	Profile Ramp Rate 3	_____	_____	_____	_____
Pnl3	Profile Setpoint Level 3	_____	_____	_____	_____
PnH3	Profile Hold Time 3	_____	_____	_____	_____
Pnr4	Profile Ramp Rate 4	_____	_____	_____	_____
Pnl4	Profile Setpoint Level 4	_____	_____	_____	_____
PnH4	Profile Hold Time 4	_____	_____	_____	_____
Pnr5	Profile Ramp Rate 5	_____	_____	_____	_____
Pnl5	Profile Setpoint Level 5	_____	_____	_____	_____
PnH5	Profile Hold Time 5	_____	_____	_____	_____
Pnr6	Profile Ramp Rate 6	_____	_____	_____	_____
Pnl6	Profile Setpoint Level 6	_____	_____	_____	_____

Configure	Timed Event Outputs	User Setting			
		PE-1	PE-2	PE-3	PE-4
Pn 1	Event 1	_____	_____	_____	_____
Pn 2	Event 2	_____	_____	_____	_____
Pn 3	Event 3	_____	_____	_____	_____
Pn 4	Event 4	_____	_____	_____	_____
Pn 5	Event 5	_____	_____	_____	_____
Pn 6	Event 6	_____	_____	_____	_____
Pn 7	Event 7	_____	_____	_____	_____
Pn 8	Event 8	_____	_____	_____	_____
Pn 9	Event 9	_____	_____	_____	_____
Pn 10	Event 10	_____	_____	_____	_____
Pn 11	Event 11	_____	_____	_____	_____
Pn 12	Event 12	_____	_____	_____	_____
Pn 13	Event 13	_____	_____	_____	_____
Pn 14	Event 14	_____	_____	_____	_____
Pn 15	Event 15	_____	_____	_____	_____
Pn 16	Event 16	_____	_____	_____	_____

Controller Operating Mode

Automatic or Manual _____

Auto-Tune Invoked at _____

APPENDIX “G” - ORDERING INFORMATION

MODEL NO.	DESCRIPTION	NEMA 4X/IP65 BEZEL	4 to 20 mA ANALOG OUTPUT	0 to 10 VDC ANALOG OUTPUT	ALARM OUTPUTS	COOLING OUTPUT	RS485 COM	PART NUMBER
TSC	Temperature Setpoint Controller	NO	YES	NO	2	NO	NO	TSC01001
		YES	YES	NO	2	NO	NO	TSC11001
		YES	YES	NO	1	YES	NO	TSC11002
		YES	YES	NO	2	NO	YES	TSC11004
		YES	YES	NO	1	YES	YES	TSC11005
		YES	NO	YES	2	NO	YES	TSC12004
		YES	NO	YES	1	YES	YES	TSC12005
	Relay Module							OMD00000
	Triac Module							OMD00001
	Logic/SSR Drive Module							OMD00003
PMK5	Panel Mount Adapter Kit (1/4 DIN to 1/8 DIN)							PMK50000
RLY5	SSR Power Unit							RLY50000
RLY6	Single Phase 25 A DIN Rail Mount Solid State Relay							RLY60000
RLY6A	Single Phase 40 A DIN Rail Mount Solid State Relay							RLY6A000
RLY7	Three Phase DIN Rail Mount Solid State Relay							RLY70000
These models have dual alarm outputs, or single alarm with cooling outputs, with shared common terminals (Form AA Type). As a result, these outputs should be fitted with the same type of output module. The main output (OP1) may be fitted with any type of output module.								

Note: Output Modules are NOT supplied with the controller. When specifying the controller, be sure to purchase the appropriate output module for the Main Control Output and if necessary, the alarm output(s) and cooling output. The controller can be fitted with any combination of output modules that do not have the RS-485 option.

The Logic/SSR Drive Module is a switched DC source, intended to drive the DC input of an SSR power unit. It should never be connected to a line voltage.

All modules are shipped separately and must be installed by the user.

This page is intentionally left blank.

LIMITED WARRANTY

The Company warrants the products it manufactures against defects in materials and workmanship for a period limited to one year from the date of shipment, provided the products have been stored, handled, installed, and used under proper conditions. The Company's liability under this limited warranty shall extend only to the repair or replacement of a defective product, at The Company's option. The Company disclaims all liability for any affirmation, promise or representation with respect to the products.

The customer agrees to hold Red Lion Controls harmless from, defend, and indemnify RLC against damages, claims, and expenses arising out of subsequent sales of RLC products or products containing components manufactured by RLC and based upon personal injuries, deaths, property damage, lost profits, and other matters which Buyer, its employees, or sub-contractors are or may be to any extent liable, including without limitation penalties imposed by the Consumer Product Safety Act (P.L. 92-573) and liability imposed upon any person pursuant to the Magnuson-Moss Warranty Act (P.L. 93-637), as now in effect or as amended hereafter.

No warranties expressed or implied are created with respect to The Company's products except those expressly contained herein. The Customer acknowledges the disclaimers and limitations contained and relies on no other warranties or affirmations.

Red Lion Controls
20 Willow Springs Circle
York PA 17402
Tel +1 (717) 767-6511
Fax +1 (717) 764-0839

Red Lion Controls BV
Basicweg 11b
NL - 3821 BR Amersfoort
Tel +31 (0) 334 723 225
Fax +31 (0) 334 893 793

Red Lion Controls AP
31, Kaki Bukit Road 3,
#06-04/05 TechLink
Singapore 417818
Tel +65 6744-6613
Fax +65 6743-3360