



ML4.1-8-H-40-RT/95/110

Diffuse mode sensor with background suppression

# ML4.1-8-H-40-RT/95/110

with M8, 4-pin metal connector



- ◆ Miniature design
- ◆ Precise background suppression
- ◆ Powerful push-pull output
- ◆ Very small black-white difference
- ◆ Red light design
- ◆ Not sensitive to ambient light, even with switched energy saving lamps

**General specifications**

Detection range	10 ... 40 mm
Light source	LED
Black/White difference (6%/90%)	approx. 3 mm
Approvals	CE, cULus
Background suppression	starts from 50 mm
Light type	red, modulated light
Diameter of the light spot	4 mm
Angle of divergence	approx. 6 °
Ambient light limit	40000 Lux

**Indicators/operating means**

Operating display	LED, green
Function display	LED yellow, lights up with receiver lit

**Electrical specifications**

Operating voltage	10 ... 30 V DC
Ripple	10 %
No-load supply current I <sub>0</sub>	25 mA

**Output**

Switching type	Light/dark on selectable electrically switchable
Signal output	Push-pull output, short-circuit proof, protected against reverse polarity
Switching voltage	max. 30 V DC
Switching current	max. 200 mA
Switching frequency f	500 Hz
Response time	1 ms

**Standard conformity**

Standards	EN 60947-5-2
-----------	--------------

**Ambient conditions**

Ambient temperature	-20 ... 60 °C (253 ... 333 K)
Storage temperature	-20 ... 75 °C (253 ... 348 K)

**Mechanical specifications**

Protection degree	IP65
Connection	M8 connector, 4-pin
Material	
Housing	ABS GV5
Optical face	glass
Mass	15 g

Release date: 2007-05-25 09:55 Date of issue: 2007-05-25 419271\_ENG.xml



Curves/Diagrams

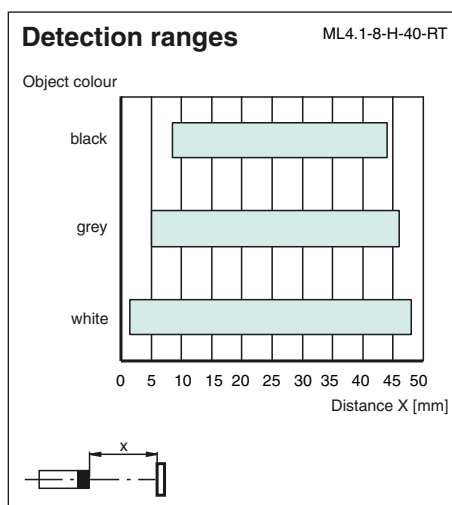
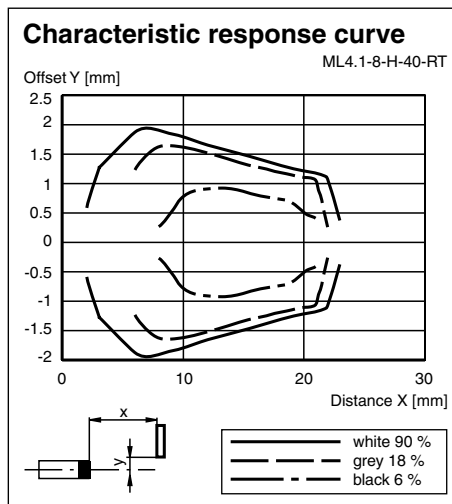
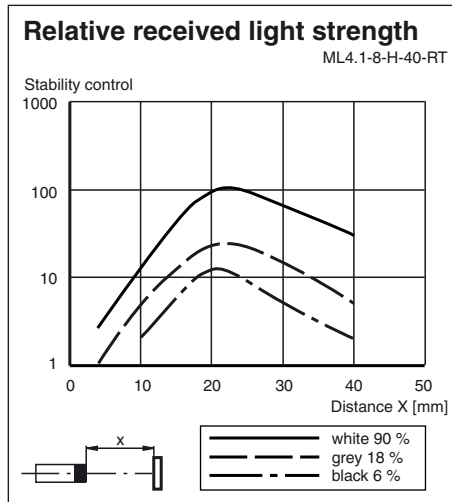

Dimensions

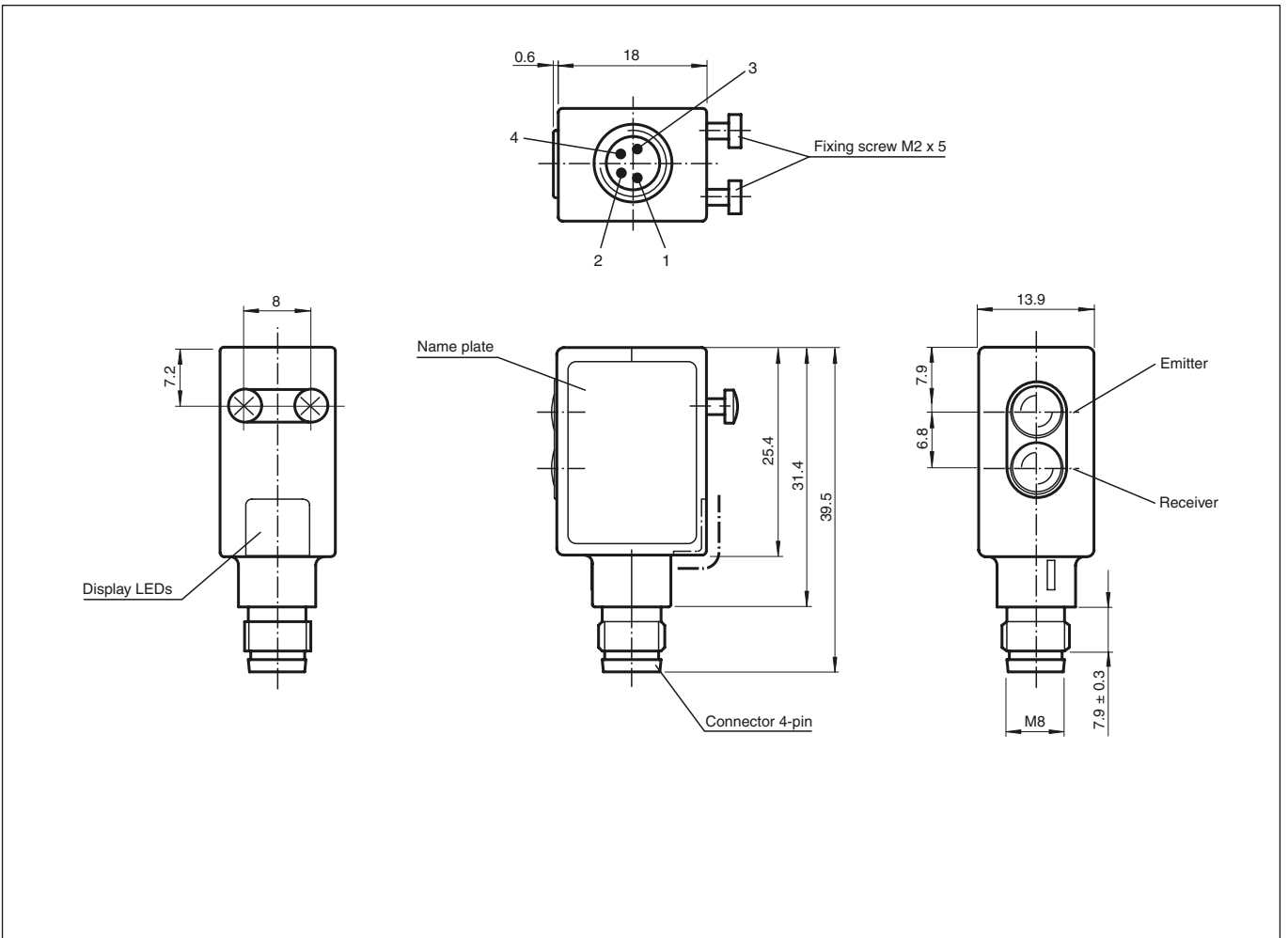

Electrical connection

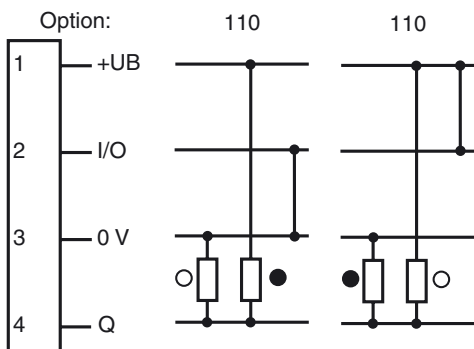

○ = light on, ● = dark on

Release date: 2007-05-25 09:55 Date of issue: 2007-05-25 419271\_ENG.xml