

Aluminum Conduit Bodies, Covers and Gaskets

For Rigid Conduit & IMC.

NEC/CEC — Suitable for use in the following
Hazardous Locations:
Class I, Division 2 per NEC 501.10(B)(4)

Applications

- To provide access to conductors for pulling, splicing, maintenance and future changes/upgrades.
- Allows connection of straight conduit runs, branch conduit runs and 90° bends.

Features

- Tapered threaded hubs (NPT).
- Internal volume and maximum wire clearly marked on castings.

Standard Materials

- Bodies: copperfree (max. 4/10 of 1%) aluminum
 - 1/2" thru 2": pressure cast
 - 2-1/2" thru 4": sand cast
- Blank covers: malleable iron, steel or copperfree (max. 4/10 of 1%) aluminum
- Cover screws: stainless steel
- Gaskets: neoprene or composition fiber

Standard Finishes

- Aluminum bodies: epoxy powder coat
- Stamped aluminum covers: natural finish
- Cast aluminum covers: epoxy powder coat

NEC/CEC Certifications and Compliances

- UL Standards: 514A
- UL Listed: E-18095w
- CSA Standard: C22.2 No. 18
- CSA Certified: 009795
- NEMA Standard: FB-1, FB-2.10

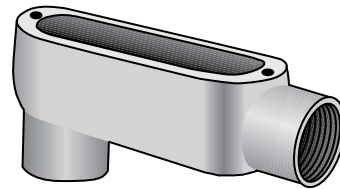

Type LB-A

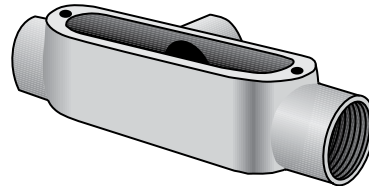

Type T-A

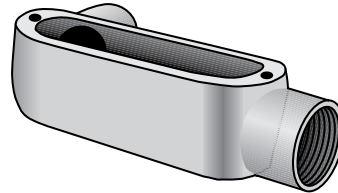

Type LL-A

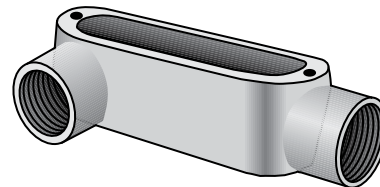

Type LR-A

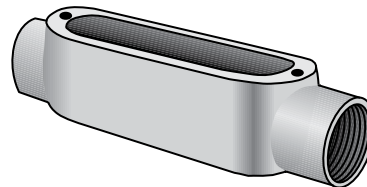

Type C-A

Aluminum Conduit Bodies, Covers and Gaskets

For Rigid Conduit & IMC.

NEC/CEC — Suitable for use in the following
Hazardous Locations:
Class I, Division 2 per NEC 501.10(B)(4)

| Aluminum Conduit Bodies | | | | |
|-------------------------|----------------|------|----------------|-----|
| Hub Size (Inches) | Max. Wire Fill | LB-A | Max. Wire Fill | T-A |

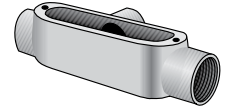
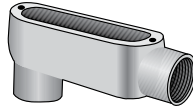

Diecast

| | | | | |
|-------|-----------|---------|-----------|--------|
| 1/2 | ① | LB-50A | ① | T-50A |
| 3/4 | (3) # 6 | LB-75A | (3) # 6 | T-75A |
| 1 | (3) # 4 | LB-100A | (3) # 4 | T-100A |
| 1-1/4 | (3) # 2 | LB-125A | (3) # 2 | T-125A |
| 1-1/2 | (3) # 1/0 | LB-150A | (3) # 1 | T-150A |
| 2 | (3) # 4/0 | LB-200A | (3) # 2/0 | T-200A |

Sandcast

| | | | | |
|-------|---------|---------|---------|--------|
| 2-1/2 | (3) 300 | LB-250A | (3) 300 | T-250A |
| 3 | (3) 400 | LB-300A | (3) 300 | T-300A |
| 3-1/2 | (3) 500 | LB-350A | (3) 350 | T-350A |
| 4 | (3) 500 | LB-400A | (3) 350 | T-400A |

| Hub Size (Inches) | Max. Wire Fill | LL-A | Max. Wire Fill | LR-A |
|-------------------|----------------|------|----------------|------|
|-------------------|----------------|------|----------------|------|

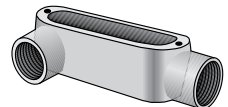
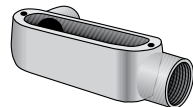

Diecast

| | | | | |
|-------|-----------|---------|-----------|---------|
| 1/2 | ① | LL-50A | ① | LR-50A |
| 3/4 | (3) # 6 | LL-75A | (3) # 6 | LR-75A |
| 1 | (3) # 4 | LL-100A | (3) # 4 | LR-100A |
| 1-1/4 | (3) # 2 | LL-125A | (3) # 2 | LR-125A |
| 1-1/2 | (3) # 1 | LL-150A | (3) # 1 | LR-150A |
| 2 | (3) # 2/0 | LL-200A | (3) # 2/0 | LR-200A |

Sandcast

| | | | | |
|-------|---------|---------|---------|---------|
| 2-1/2 | (3) 300 | LL-250A | (3) 300 | LR-250A |
| 3 | (3) 350 | LL-300A | (3) 350 | LR-300A |
| 3-1/2 | (3) 350 | LL-350A | (3) 350 | LR-350A |
| 4 | (3) 350 | LL-400A | (3) 350 | LR-400A |

① All 1/2" Max Wire Fill Calculations per the NEC - Annex C - Table C8.

Aluminum Conduit Bodies, Covers and Gaskets

For Rigid Conduit & IMC.

NEC/CEC — Suitable for use in the following
Hazardous Locations:
Class I, Division 2 per NEC 501.10(B)(4)

Aluminum Conduit Bodies

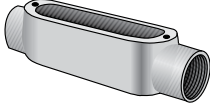
| Hub Size (Inches) | Max. Wire Fill | Diecast | Sandcast |
|----------------------|----------------|------------------------------------------------------------------------------------|----------|
| | | C-A | |
| | |  | |
| 1/2 | ① | C-50A | — |
| 3/4 | (3) # 6 | C-75A | — |
| 1 | (3) # 4 | C-100A | — |
| 1-1/4 | (3) # 2 | C-125A | — |
| 1-1/2 | (3) # 1/0 | C-150A | — |
| 2 | (3) # 3/0 | C-200A | — |
| 2-1/2 | (3) 300 | — | C-250A |
| 3 | (3) 300 | — | C-300A |
| 3-1/2 | (3) 350 | — | C-350A |
| 4 | (3) 350 | — | C-400A |

| Hub Size (Inches) | Max. Wire Fill | Sandcast | | |
|----------------------|----------------|--------------------------------------------------------------------------------------|----------------|--------|
| | | TB-A | Max. Wire Fill | X-A |
| | |  | | |
| 1/2 | ① | TB-50A | ① | X-50A |
| 3/4 | (3) # 6 | TB-75A | (3) # 6 | X-75A |
| 1 | (3) # 6 | TB-100A | (3) # 4 | X-100A |
| 1-1/4 | (3) # 6 | TB-125A | — | X-125A |
| 1-1/2 | (3) # 4 | TB-150A | — | X-150A |
| 2 | (3) # 1/0 | TB-200A | — | X-200A |
| 2-1/2 | — | — | — | — |
| 3 | — | — | — | — |
| 3-1/2 | — | — | — | — |
| 4 | — | — | — | — |



① All 1/2" Max Wire Fill Calculations per the NEC - Annex C - Table C8.

Aluminum Conduit Bodies, Covers and Gaskets

For Rigid Conduit & IMC.

NEC/CEC — Suitable for use in the following
 Hazardous Locations:
 Class I, Division 2 per NEC 501.10(B)(4)

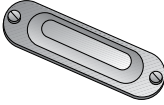
Blank Covers and Gaskets ①

| Body Size (Inches) | Domed Top Design Cover | Solid Cover Sealing Gasket | |
|-----------------------|-----------------------------------------------------------------------------------|-------------------------------------------------------------------------------------|----------------|
| | | Velbuna | Neoprene |
| |  |  | |
| 1/2 | BS-50A | SG-50 | SGN-50 |
| 3/4 | BS-75A | SG-75 | SGN-75 |
| 1 | BS-100A | SG-100 | SGN-100 |
| 1-1/4 - 1-1/2 | BS-125A | SG-125 | SGN-125 |
| 2 | BS-200A | SG-200 | SGN-200 |
| 2-1/2 - 3 | BS-250A | SG-250 | SGN-250 |
| 3-1/2 - 4 | BS-350A ① | SG-350 | SGN-350 |

① Flat Top Design Cover

Aluminum Conduit Bodies, Covers and Gaskets

For Rigid Conduit & IMC.

NEC/CEC — Suitable for use in the following
Hazardous Locations:
Class I, Division 2 per NEC 501.10(B)(4)

Dimensions in Millimeters (Inches)

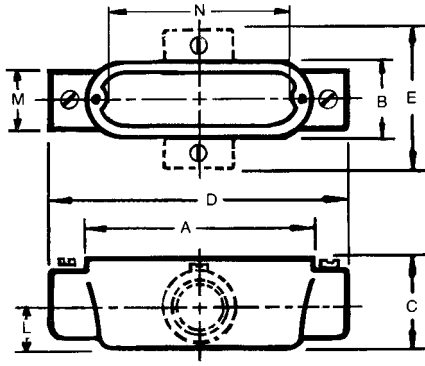

Types C, T, TB, X

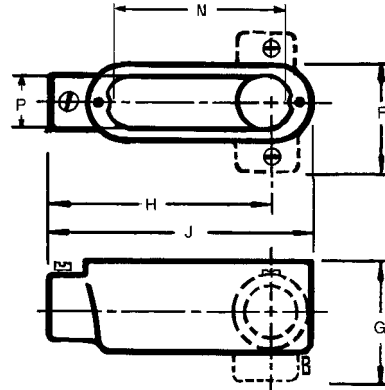

Types LB, LL, LR

| Hub Size (Inches) | Dimensions In Millimeters (Inches) | | | | | | | | | | | | | |
|----------------------|------------------------------------|-----------------|-----------------|------------------|----------------|-----------------|-----------------|------------------|------------------|----------------|-----------------|------------------|-----------------|--|
| | A | B | C | D | E | F | G | H | J | L | M | N | P | |
| Pressure Cast | | | | | | | | | | | | | | |
| 1/2 | 100.1 (3.94) | 33.3 (1.31) | 35.1 (1.38) | 120.7 (4.75) | 65.0 (2.56) | 50.8 (2.00) | 52.3 (2.06) | 88.9 (3.50) | 109.5 (4.31) | 16.0 (0.63) | 28.7 (1.13) | 79.8 (3.14) | 26.7 (1.05) | |
| 3/4 | 117.6 (4.63) | 39.6 (1.56) | 41.4 (1.63) | 143.0 (5.63) | 76.2 (3.00) | 57.2 (2.25) | 62.0 (2.44) | 104.9 (4.13) | 130.3 (5.13) | 19.1 (0.75) | 35.1 (1.38) | 96.0 (3.78) | 32.3 (1.27) | |
| 1 | 136.7 (5.38) | 46.0 (1.81) | 47.8 (1.88) | 169.9 (6.69) | 88.9 (3.50) | 66.8 (2.63) | 71.4 (2.81) | 124.0 (4.88) | 152.4 (6.00) | 23.9 (0.94) | 42.9 (1.69) | 114.3 (4.50) | 38.6 (1.52) | |
| 1-1/4 | 182.6 (7.19) | 63.5 (2.50) | 69.9 (2.75) | 217.4 (8.56) | — | 88.9 (3.50) | 98.6 (3.88) | 166.6 (6.56) | 200.2 (7.88) | 26.9 (1.06) | 54.1 (2.13) | 152.4 (6.00) | 57.2 (2.25) | |
| 1-1/2 | 182.6 (7.19) | 63.5 (2.50) | 69.9 (2.75) | 217.4 (8.56) | — | 88.9 (3.50) | 96.8 (3.81) | 163.6 (6.44) | 200.2 (7.88) | 30.2 (1.19) | 60.5 (2.38) | 152.4 (6.00) | 57.2 (2.25) | |
| 2 | 241.3 (9.50) | 79.5 (3.13) | 87.4 (3.44) | 274.6 (10.81) | — | 106.4 (4.19) | 115.8 (4.56) | 211.1 (8.31) | 258.8 (10.19) | 38.1 (1.50) | 74.7 (2.94) | 204.7 (8.06) | 69.9 (2.75) | |
| Sand Cast | | | | | | | | | | | | | | |
| 2-1/2 | 311.2 (12.25) | 109.5 (4.31) | 98.6 (3.88) | 384.3 (15.13) | — | 146.1 (5.75) | 133.4 (5.25) | 301.8 (11.88) | 347.7 (13.69) | 46.0 (1.81) | 85.9 (3.38) | 270.0 (10.63) | 93.7 (3.69) | |
| 3 | 311.2 (12.25) | 109.5 (4.31) | 117.6 (4.63) | 384.3 (15.13) | — | 146.1 (5.75) | 152.4 (6.00) | 293.6 (11.56) | 347.7 (13.69) | 55.6 (2.19) | 104.9 (4.13) | 270.0 (10.63) | 93.7 (3.69) | |
| 3-1/2 | 378.0 (14.88) | 139.7 (5.50) | 131.8 (5.19) | 460.5 (18.13) | — | 181.1 (7.13) | 173.0 (6.81) | 355.6 (14.00) | 419.1 (16.50) | 63.5 (2.50) | 120.7 (4.75) | 333.5 (13.13) | 124.0 (4.88) | |
| 4 | 378.0 (14.88) | 139.7 (5.50) | 141.2 (5.56) | 460.5 (18.13) | — | 181.1 (7.13) | 182.6 (7.19) | 349.3 (13.75) | 419.1 (16.50) | 69.9 (2.75) | 130.3 (5.13) | 333.5 (13.13) | 124.0 (4.88) | |

Aluminum Conduit Bodies, Covers and Gaskets

For Rigid Conduit & IMC.

NEC/CEC — Suitable for use in the following
Hazardous Locations:
Class I, Division 2 per NEC 501.10(B)(4)

Applications

- To provide access to conductors for pulling, splicing, maintenance and future changes/ upgrades.
- Allows connection of straight conduit runs, branch conduit runs and 90° bends.

Features

- Tapered threaded hubs (NPT).
- Packaged complete with cover and gasket under one Catalog Number.
- Ready to use.

Standard Materials

- Conduit Body: copperfree (max. 4/10 of 1%) aluminum
- Cover: **Type BS** copperfree (max. 4/10 of 1%) aluminum
- Gasket: **Type SGN** Neoprene

Standard Finishes

- Conduit Body - epoxy powder coat enamel

NEC/CEC Certifications and Compliances

- UL Standards: 514A
- UL Listed: E-18095
- CSA Standard: C22.2 No. 18
- CSA Certified: LR-9795
- NEMA Standard: FB-1, FB-2.10

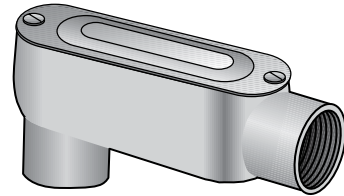

Type LB-ACG

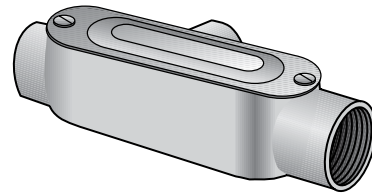

Type T-ACG

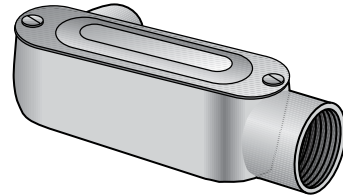

Type LL-ACG

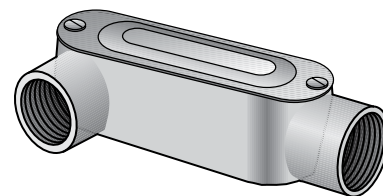

Type LR-ACG

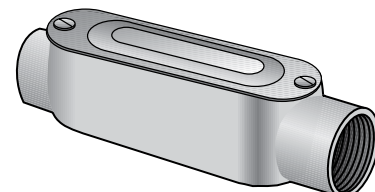

Type C-ACG

OZ/GEDNEY™

COMMERCIAL AND INDUSTRIAL FITTINGS: CONDUIT BODIES



Aluminum Conduit Bodies, Covers and Gaskets

For Rigid Conduit & IMC.

NEC/CEC — Suitable for use in the following
Hazardous Locations:
Class I, Division 2 per NEC 501.10(B)(4)

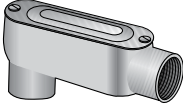
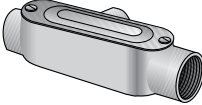
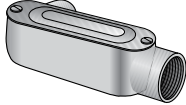
Aluminum Conduit Bodies

| Hub Size (Inches) | Max. Wire Fill | LB-ACG | Max. Wire Fill | T-ACG | Max. Wire Fill | LL-ACG |
|-------------------|----------------|-----------------------------------------------------------------------------------|----------------|------------------------------------------------------------------------------------|----------------|-------------------------------------------------------------------------------------|
| | |  | |  | |  |
| 1/2 | ① | LB-50ACG | ① | T-50ACG | ① | LL-50ACG |
| 3/4 | (3) # 6 | LB-75ACG | (3) # 6 | T-75ACG | (3) # 6 | LL-75ACG |
| 1 | (3) # 4 | LB-100ACG | (3) # 4 | T-100ACG | (3) # 4 | LL-100ACG |
| 1-1/4 | (3) # 2 | LB-125ACG | (3) # 2 | T-125ACG | (3) # 2 | LL-125ACG |
| 1-1/2 | (3) # 1/0 | LB-150ACG | (3) # 1 | T-150ACG | (3) # 1 | LL-150ACG |
| 2 | (3) # 4/0 | LB-200ACG | (3) # 2/0 | T-200ACG | (3) # 2/0 | LL-200ACG |

| Hub Size (Inches) | Max. Wire Fill | LR-ACG | Max. Wire Fill | C-ACG |
|-------------------|----------------|------------------------------------------------------------------------------------|----------------|--------------------------------------------------------------------------------------|
| | |  | |  |
| 1/2 | ① | LR-50ACG | ① | C-50ACG |
| 3/4 | (3) # 6 | LR-75ACG | (3) # 6 | C-75ACG |
| 1 | (3) # 4 | LR-100ACG | (3) # 4 | C-100ACG |
| 1-1/4 | (3) # 2 | LR-125ACG | (3) # 2 | C-125ACG |
| 1-1/2 | (3) # 1 | LR-150ACG | (3) # 1/0 | C-150ACG |
| 2 | (3) # 2/0 | LR-200ACG | (3) # 3/0 | C-200ACG |

① All 1/2" Max Wire Fill Calculations per the NEC - Annex C - Table C8.

Aluminum Conduit Bodies, Covers and Gaskets

For Rigid Conduit & IMC.

NEC/CEC — Suitable for use in the following
Hazardous Locations:
Class I, Division 2 per NEC 501.10(B)(4)

Dimensions in Millimeters (Inches)

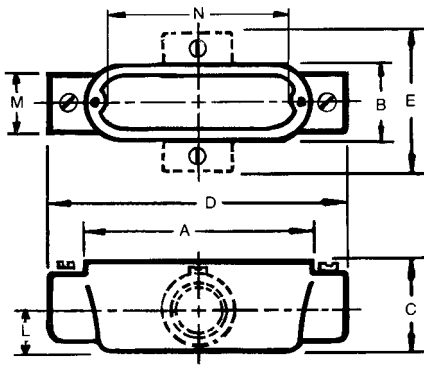

Types C, T, TB, X

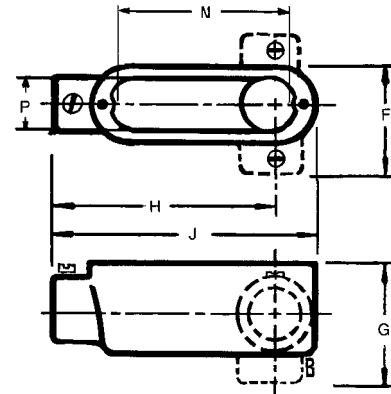

Types LB, LL, LR

| Hub Size (Inches) | Dimensions In Millimeters (Inches) | | | | | | | | | | | | | |
|----------------------|------------------------------------|-----------------|-----------------|------------------|----------------|-----------------|-----------------|------------------|------------------|----------------|-----------------|------------------|-----------------|--|
| | A | B | C | D | E | F | G | H | J | L | M | N | P | |
| Pressure Cast | | | | | | | | | | | | | | |
| 1/2 | 100.1 (3.94) | 33.3 (1.31) | 35.1 (1.38) | 120.7 (4.75) | 65.0 (2.56) | 50.8 (2.00) | 52.3 (2.06) | 88.9 (3.50) | 109.5 (4.31) | 16.0 (0.63) | 28.7 (1.13) | 79.8 (3.14) | 26.7 (1.05) | |
| 3/4 | 117.6 (4.63) | 39.6 (1.56) | 41.4 (1.63) | 143.0 (5.63) | 76.2 (3.00) | 57.2 (2.25) | 62.0 (2.44) | 104.9 (4.13) | 130.3 (5.13) | 19.1 (0.75) | 35.1 (1.38) | 96.0 (3.78) | 32.3 (1.27) | |
| 1 | 136.7 (5.38) | 46.0 (1.81) | 47.8 (1.88) | 169.9 (6.69) | 88.9 (3.50) | 66.8 (2.63) | 71.4 (2.81) | 124.0 (4.88) | 152.4 (6.00) | 23.9 (0.94) | 42.9 (1.69) | 114.3 (4.50) | 38.6 (1.52) | |
| 1-1/4 | 182.6 (7.19) | 63.5 (2.50) | 69.9 (2.75) | 217.4 (8.56) | — | 88.9 (3.50) | 98.6 (3.88) | 166.6 (6.56) | 200.2 (7.88) | 26.9 (1.06) | 54.1 (2.13) | 152.4 (6.00) | 57.2 (2.25) | |
| 1-1/2 | 182.6 (7.19) | 63.5 (2.50) | 69.9 (2.75) | 217.4 (8.56) | — | 88.9 (3.50) | 96.8 (3.81) | 163.6 (6.44) | 200.2 (7.88) | 30.2 (1.19) | 60.5 (2.38) | 152.4 (6.00) | 57.2 (2.25) | |
| 2 | 241.3 (9.50) | 79.5 (3.13) | 87.4 (3.44) | 274.6 (10.81) | — | 106.4 (4.19) | 115.8 (4.56) | 211.1 (8.31) | 258.8 (10.19) | 38.1 (1.50) | 74.7 (2.94) | 204.7 (8.06) | 69.9 (2.75) | |
| Sand Cast | | | | | | | | | | | | | | |
| 2-1/2 | 311.2 (12.25) | 109.5 (4.31) | 98.6 (3.88) | 384.3 (15.13) | — | 146.1 (5.75) | 133.4 (5.25) | 301.8 (11.88) | 347.7 (13.69) | 46.0 (1.81) | 85.9 (3.38) | 270.0 (10.63) | 93.7 (3.69) | |
| 3 | 311.2 (12.25) | 109.5 (4.31) | 117.6 (4.63) | 384.3 (15.13) | — | 146.1 (5.75) | 152.4 (6.00) | 293.6 (11.56) | 347.7 (13.69) | 55.6 (2.19) | 104.9 (4.13) | 270.0 (10.63) | 93.7 (3.69) | |
| 3-1/2 | 378.0 (14.88) | 139.7 (5.50) | 131.8 (5.19) | 460.5 (18.13) | — | 181.1 (7.13) | 173.0 (6.81) | 355.6 (14.00) | 419.1 (16.50) | 63.5 (2.50) | 120.7 (4.75) | 333.5 (13.13) | 124.0 (4.88) | |
| 4 | 378.0 (14.88) | 139.7 (5.50) | 141.2 (5.56) | 460.5 (18.13) | — | 181.1 (7.13) | 182.6 (7.19) | 349.3 (13.75) | 419.1 (16.50) | 69.9 (2.75) | 130.3 (5.13) | 333.5 (13.13) | 124.0 (4.88) | |

OX/GEDNEY

COMMERCIAL AND INDUSTRIAL FITTINGS: CONDUIT BODIES

Aluminum Conduit Bodies, Covers and Gaskets

Set Screw Type for EMT (Thinwall Conduit).

NEC/CEC — Suitable for use in the following
Hazardous Locations:
Class I, Division 2 per NEC 501.10(B)(4)

Applications

- To provide access to conductors for pulling, splicing, maintenance and future changes/ upgrades.
- Allows connection of straight conduit runs, branch conduit runs and 90° bends.

Features

- Slotted hex head steel hardened cup-point set screw for EMT.
- Internal volume and maximum wire clearly marked on castings.

Standard Materials

- Diecast copperfree (max. 4/10 of 1%) aluminum

Standard Finishes

- Aluminum enamel

NEC/CEC Certifications and Compliances

- UL Standards: 514A
- UL Listed: E-18095
- CSA Standard: C22.2 No. 18
- CSA Certified: 009795
- NEMA Standard: FB-1, FB-2.10

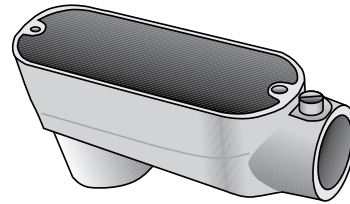

Type LB-TW

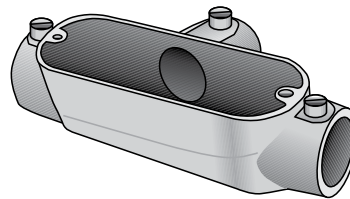

Type T-TW

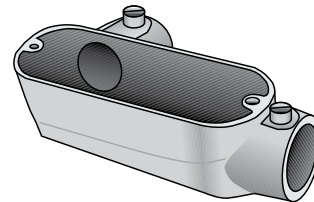

Type LL-TW

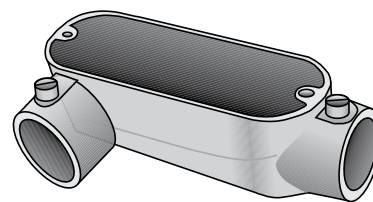

Type LR-TW

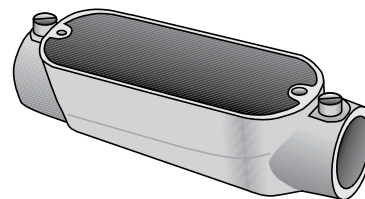

Type C-TW

Aluminum Conduit Bodies, Covers and Gaskets

Set Screw Type for EMT (Thinwall Conduit).

NEC/CEC — Suitable for use in the following
Hazardous Locations:
Class I, Division 2 per NEC 501.10(B)(4)

Aluminum Conduit Bodies

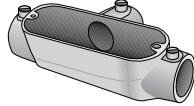
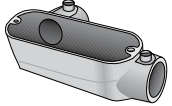
| Hub Size (Inches) | Max. Wire Fill | LB-TW | Max. Wire Fill | T-TW | Max. Wire Fill | LL-TW |
|-------------------|----------------|-----------------------------------------------------------------------------------|----------------|------------------------------------------------------------------------------------|----------------|-------------------------------------------------------------------------------------|
| | |  | |  | |  |
| 1/2 | ① | LB-50ATW | ① | T-50ATW | ① | LL-50ATW |
| 3/4 | (3) # 6 | LB-75ATW | (3) # 6 | T-75ATW | (3) # 6 | LL-75ATW |
| 1 | (3) # 4 | LB-100ATW | (3) # 4 | T-100ATW | (3) # 4 | LL-100ATW |
| 1-1/4 | (3) # 2 | LB-125ATW | (3) # 2 | T-125ATW | (3) # 2 | LL-125ATW |
| 1-1/2 | (3) # 1/0 | LB-150ATW | (3) # 1 | T-150ATW | (3) # 1 | LL-150ATW |
| 2 | (3) # 4/0 | LB-200ATW | (3) # 2/0 | T-200ATW | (3) # 2/0 | LL-200ATW |

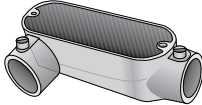
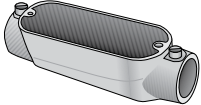
| Hub Size (Inches) | Max. Wire Fill | LR-TW | Max. Wire Fill | C-TW |
|-------------------|----------------|------------------------------------------------------------------------------------|----------------|--------------------------------------------------------------------------------------|
| | |  | |  |
| 1/2 | ① | LR-50ATW | ① | C-50ATW |
| 3/4 | (3) # 6 | LR-75ATW | (3) # 6 | C-75ATW |
| 1 | (3) # 4 | LR-100ATW | (3) # 4 | C-100ATW |
| 1-1/4 | (3) # 2 | LR-125ATW | (3) # 2 | C-125ATW |
| 1-1/2 | (3) # 1 | LR-150ATW | (3) # 1/0 | C-150ATW |
| 2 | (3) # 2/0 | LR-200ATW | (3) # 3/0 | C-200ATW |



① All 1/2" Max Wire Fill Calculations per the NEC - Annex C - Table C8.

Aluminum Conduit Bodies, Covers and Gaskets

For Rigid Conduit & IMC.

NEC/CEC — Suitable for use in the following
Hazardous Locations:
Class I, Division 2 per NEC 501.10(B)(4)

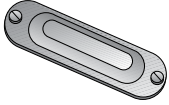
Blank Covers and Gaskets ①

| Body Size (Inches) | Domed Top Design Cover | Solid Cover Sealing Gasket | |
|-----------------------|-----------------------------------------------------------------------------------|------------------------------------------------------------------------------------|----------------|
| | | Velbuna | Neoprene |
| |  |  | |
| 1/2 | BS-50A | SG-50 | SGN-50 |
| 3/4 | BS-75A | SG-75 | SGN-75 |
| 1 | BS-100A | SG-100 | SGN-100 |
| 1-1/4 - 1-1/2 | BS-125A | SG-125 | SGN-125 |
| 2 | BS-200A | SG-200 | SGN-200 |
| 2-1/2 - 3 | BS-250A | SG-250 | SGN-250 |
| 3-1/2 - 4 | BS-350A ① | SG-350 | SGN-350 |

① Flat Top Design Cover

Aluminum Conduit Bodies, Covers and Gaskets

For Rigid Conduit & IMC.

NEC/CEC — Suitable for use in the following
Hazardous Locations:
Class I, Division 2 per NEC 501.10(B)(4)

Dimensions in Millimeters (Inches)

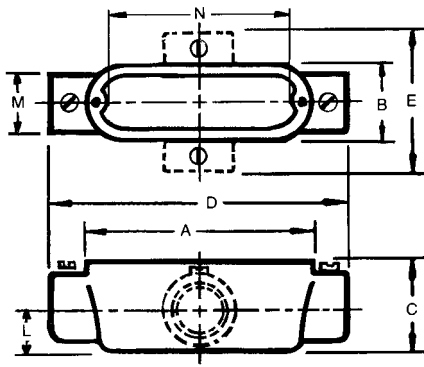

Types C, T, TB, X

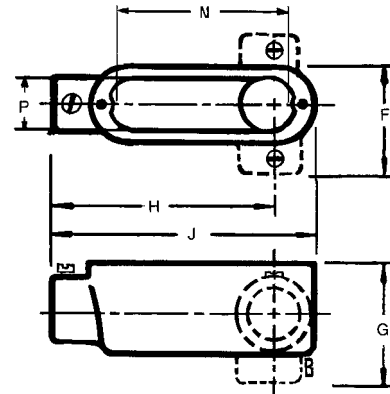

Types LB, LL, LR

| Hub Size (Inches) | Dimensions In Millimeters (Inches) | | | | | | | | | | | | |
|----------------------|------------------------------------|-----------------|-----------------|------------------|----------------|-----------------|-----------------|------------------|------------------|----------------|-----------------|------------------|-----------------|
| | A | B | C | D | E | F | G | H | J | L | M | N | P |
| Pressure Cast | | | | | | | | | | | | | |
| 1/2 | 100.1 (3.94) | 33.3 (1.31) | 35.1 (1.38) | 120.7 (4.75) | 65.0 (2.56) | 50.8 (2.00) | 52.3 (2.06) | 88.9 (3.50) | 109.5 (4.31) | 16.0 (0.63) | 28.7 (1.13) | 79.8 (3.14) | 26.7 (1.05) |
| 3/4 | 117.6 (4.63) | 39.6 (1.56) | 41.4 (1.63) | 143.0 (5.63) | 76.2 (3.00) | 57.2 (2.25) | 62.0 (2.44) | 104.9 (4.13) | 130.3 (5.13) | 19.1 (0.75) | 35.1 (1.38) | 96.0 (3.78) | 32.3 (1.27) |
| 1 | 136.7 (5.38) | 46.0 (1.81) | 47.8 (1.88) | 169.9 (6.69) | 88.9 (3.50) | 66.8 (2.63) | 71.4 (2.81) | 124.0 (4.88) | 152.4 (6.00) | 23.9 (0.94) | 42.9 (1.69) | 114.3 (4.50) | 38.6 (1.52) |
| 1-1/4 | 182.6 (7.19) | 63.5 (2.50) | 69.9 (2.75) | 217.4 (8.56) | — | 88.9 (3.50) | 98.6 (3.88) | 166.6 (6.56) | 200.2 (7.88) | 26.9 (1.06) | 54.1 (2.13) | 152.4 (6.00) | 57.2 (2.25) |
| 1-1/2 | 182.6 (7.19) | 63.5 (2.50) | 69.9 (2.75) | 217.4 (8.56) | — | 88.9 (3.50) | 96.8 (3.81) | 163.6 (6.44) | 200.2 (7.88) | 30.2 (1.19) | 60.5 (2.38) | 152.4 (6.00) | 57.2 (2.25) |
| 2 | 241.3 (9.50) | 79.5 (3.13) | 87.4 (3.44) | 274.6 (10.81) | — | 106.4 (4.19) | 115.8 (4.56) | 211.1 (8.31) | 258.8 (10.19) | 38.1 (1.50) | 74.7 (2.94) | 204.7 (8.06) | 69.9 (2.75) |
| Sand Cast | | | | | | | | | | | | | |
| 2-1/2 | 311.2 (12.25) | 109.5 (4.31) | 98.6 (3.88) | 384.3 (15.13) | — | 146.1 (5.75) | 133.4 (5.25) | 301.8 (11.88) | 347.7 (13.69) | 46.0 (1.81) | 85.9 (3.38) | 270.0 (10.63) | 93.7 (3.69) |
| 3 | 311.2 (12.25) | 109.5 (4.31) | 117.6 (4.63) | 384.3 (15.13) | — | 146.1 (5.75) | 152.4 (6.00) | 293.6 (11.56) | 347.7 (13.69) | 55.6 (2.19) | 104.9 (4.13) | 270.0 (10.63) | 93.7 (3.69) |
| 3-1/2 | 378.0 (14.88) | 139.7 (5.50) | 131.8 (5.19) | 460.5 (18.13) | — | 181.1 (7.13) | 173.0 (6.81) | 355.6 (14.00) | 419.1 (16.50) | 63.5 (2.50) | 120.7 (4.75) | 333.5 (13.13) | 124.0 (4.88) |
| 4 | 378.0 (14.88) | 139.7 (5.50) | 141.2 (5.56) | 460.5 (18.13) | — | 181.1 (7.13) | 182.6 (7.19) | 349.3 (13.75) | 419.1 (16.50) | 69.9 (2.75) | 130.3 (5.13) | 333.5 (13.13) | 124.0 (4.88) |

OX/GEDNEY

COMMERCIAL AND INDUSTRIAL FITTINGS: CONDUIT BODIES