

Miniature Circuit Breakers and Supplementary Protectors

Miniature Circuit Breakers and Supplementary Protectors



1.1 Industrial Circuit Breakers

QUICKLAG®	V4-T1-2
QUICKLAG Plug-On Types HQP, QPHW, QHPX, QHPW	V4-T1-5
QUICKLAG Plug-On Ground Fault and Equipment Protectors, Types QPGF, QPHGF, QPGFEP, QPHGFEP	V4-T1-8
Bolt-On Types BAB, QBHW, HBAX, HBAW	V4-T1-11
Bolt-On Arc Fault Circuit Interrupter Types QBAF, QBCAF	V4-T1-14
Bolt-On Ground Fault and Equipment Protectors, Types QBGF, QBHGF, QBGFEP, QBHGFEP	V4-T1-17
Cable-In/Cable-Out Types QC, QCD, QCHW, QHCX, QHCW	V4-T1-20
Cable-In/Cable-Out, 1/2-Inch Wide, Types QCR, QCF, QCRH, QCFH	V4-T1-24
Cable-In/Cable-Out Ground Fault and Equipment Protectors, Types QCGF, QCHGF, QCGFEP, QCHGFEP	V4-T1-28
Solenoid-Operated, Remote-Controlled Latching Types BABRP, BABRSP, BRRP and CLRP	V4-T1-31
Solenoid Operator—Remote-Controlled Latching for Type GHBS, GBHS and GHQRSP Breakers	V4-T1-34
International Rated Types HQP, BA, QC, GFMB, GFXBC	V4-T1-37
Special Application Breakers, Types HQP, BA, QC	V4-T1-40

1.2 UL 489 DIN Rail Miniature Circuit Breakers

FAZ-NA Circuit Breakers	V4-T1-49
-------------------------------	----------

1.3 UL 1077 DIN Rail Supplementary Protectors

FAZ Circuit Breakers	V4-T1-67
----------------------------	----------

1.4 UL 1053 DIN Rail RCCB

UL 1053 DIN Rail RCCB 480/277 Vac	V4-T1-87
UL 1053 DIN Rail RCCB 208Y/120 Vac	V4-T1-93



1.1

Miniature Circuit Breakers and Supplementary Protectors

Industrial Circuit Breakers

1

Miniature Circuit Breakers and Supplementary Protectors



Contents

Description

Quick Reference

QUICKLAG

Quick Reference

Eaton's QUICKLAG Industrial Circuit Breakers ① Plug-In, Bolt-On, Cable-In/Cable-Out

Circuit Breaker Type	Circuit Breaker Type Code	Continuous Ampere Rating at 40°C	Number of Poles	Vac		Federal Spec. W-C-375b	Interrupting Ratings rms Symmetrical Amperes						Page Number
				Vac	Vdc		Vac Ratings			Vdc Ratings ②			
							120	120/240	240	24-48	62.5	80	
HQP	P	10-70	1	120/240	24, 48, 62.5	10a, 11a, 12a	—	10,000	—	5000	③	—	V4-T1-6
HQP	P	10-125	2	120/240	24, 48, 80	10a, 12a	—	10,000	—	5000	5000	5000	V4-T1-6
HQP	P	10-100	2, 3	240	—	10b, 11b, 12b	—	—	10,000	—	—	—	V4-T1-6
QPHW	P	15-70	1	120/240	24, 48, 62.5	14a	—	22,000	—	5000	③	—	V4-T1-6
QPHW	P	15-125	2	120/240	24, 48, 80	14a	—	22,000	—	5000	5000	5000	V4-T1-6
QPHW	P	15-100	2, 3	240	—	14b	—	—	22,000	—	—	—	V4-T1-6
QHPX	P	15-70	1	120/240	24, 48, 62.5	—	—	42,000	—	5000	③	—	V4-T1-7
QHPX	P	15-100	2	120/240	24, 48, 80	—	—	42,000	—	5000	5000	5000	V4-T1-7
QHPX	P	15-100	3	240	—	—	—	—	42,000	—	—	—	V4-T1-7
QHPW	P	15-30	1	120/240	24, 48, 62.5	15a	—	65,000	—	5000	③	—	V4-T1-7
QHPW	P	15-30	2	120/240	24, 48, 80	15a	—	65,000	—	5000	5000	5000	V4-T1-7
QHPW	P	15-20	3	240	—	15b	—	—	65,000	—	—	—	V4-T1-7
QPGF	P, GF	15-40	1	120	—	10a, 11a, 12a	10,000	—	—	—	—	—	V4-T1-9
QPGF	P, GF	15-50	2	120/240	—	10a, 11a, 12a	—	10,000	—	—	—	—	V4-T1-9

Notes

① QUICKLAG circuit breakers are suitable for application in relative humidity 0-95% noncondensing.

② Two-pole DC interrupting ratings based on two poles connected in series. Not UL® listed.

③ 62.5 Vac interrupting rating is 3800 AIC 10-50A and 2500 AIC 55-100A continuous.

Circuit Breaker Type Codes: **P** Plug-In; **B** Bolt-On; **C** Cable-In/Cable-Out; **GF** Ground Fault, 5 mA; **GFEP** Ground Fault, 30 mA.

For Types GHBS, GBHS and BABRP solenoid-operated, remote-controlled circuit breakers, see **Pages V4-T1-31 to V4-T1-36**.

Eaton's QUICKLAG Industrial Circuit Breakers ① Plug-In, Bolt-On, Cable-In/Cable-Out, continued

Circuit Breaker Type	Circuit Breaker Type Code	Continuous Ampere Rating at 40°C	Number of Poles	Vac		Federal Spec. W-C-375b	Interrupting Ratings rms Symmetrical Amperes						Page Number
				Vac	Vdc		Vac Ratings			Vdc Ratings ②			
							120	120/240	240	24-48	62.5	80	
QPHGF	P, GF	15-30	1	120	—	10a, 11a, 12a	22,000	—	—	—	—	—	V4-T1-9
QPHGF	P, GF	15-50	2	120/240	—	10a, 11a, 12a	—	22,000	—	—	—	—	V4-T1-9
QPGFEP	P, GFEP	15-40	1	120	—	—	10,000	—	—	—	—	—	V4-T1-9
QPGFEP	P, GFEP	15-50	2	120/240	—	—	—	10,000	—	—	—	—	V4-T1-9
QPHGFEP	P, GFEP	15-30	1	120	—	—	22,000	—	—	—	—	—	V4-T1-9
BABRSP	B	15-30	1	120	—	—	10,000	—	—	—	—	—	V4-T1-12
BABRSP	B	15-30	2	120/240	—	—	—	10,000	—	—	—	—	V4-T1-12
BRRP	P	15-30	1	120	—	—	10,000	—	—	—	—	—	V4-T1-32
BRRP	P	15-30	2	120/240	—	—	—	10,000	—	—	—	—	V4-T1-32
CLRP	P	15-30	1	120	—	—	10,000	—	—	—	—	—	V4-T1-32
CLRP	P	15-30	2	120/240	—	—	—	10,000	—	—	—	—	V4-T1-32
BAB	B	10-70	1	120/240	24, 48, 62.5	10a, 11a, 12a	—	10,000	—	5000	③	—	V4-T1-12
BAB	B	10-125	2	120/240	24, 48, 80	10a, 12a	—	10,000	—	5000	5000	5000	V4-T1-12
BAB	B	10-100	2, 3	240	—	10b, 11b, 12b	—	—	10,000	—	—	—	V4-T1-12
BABRP	B	15-30	1	120	—	—	10,000	—	—	—	—	—	V4-T1-32
BABRP	B	15-30	2	120/240	—	—	—	10,000	—	—	—	—	V4-T1-32
QBAF	B, AF	15-20	1, 2	120/240	—	—	—	10,000	—	—	—	—	V4-T1-15
QBCAF	B, AF, GF	15-20	1, 2	120/240	—	—	—	10,000	—	—	—	—	V4-T1-15
QBHW	B	15-70	1	120/240	24, 48, 62.5	14a	—	22,000	—	5000	③	—	V4-T1-12
QBHW	B	15-125	2	120/240	24, 48, 80	14a	—	22,000	—	5000	5000	5000	V4-T1-12
QBHW	B	15-100	2, 3	240	—	14b	—	—	22,000	—	—	—	V4-T1-12
HBAX	B	15-70	1	120/240	24, 48, 62.5	—	—	42,000	—	5000	③	—	V4-T1-13
HBAX	B	15-100	2	120/240	24, 48, 80	—	—	42,000	—	5000	5000	5000	V4-T1-13
HBAX	B	15-100	3	240	—	—	—	—	42,000	—	—	—	V4-T1-13
HBAW	B	15-30	1	120/240	24, 48, 62.5	15a	—	65,000	—	5000	③	—	V4-T1-13
HBAW	B	15-30	2	120/240	24, 48, 80	15a	—	65,000	—	5000	5000	5000	V4-T1-13
HBAW	B	15-20	3	240	—	15b	—	—	65,000	—	—	—	V4-T1-13
QBGf	B, GF	15-40	1	120	—	10a, 11a, 12a	10,000	—	—	—	—	—	V4-T1-18
QBGf	B, GF	15-50	2	120/240	—	10a, 11a, 12a	—	10,000	—	—	—	—	V4-T1-18
QBHGf	B, GF	15-30	1	120	—	10a, 11a, 12a	22,000	—	—	—	—	—	V4-T1-18
QBHGf	B, GF	15-30	1	120/240	—	10a, 11a, 12a	—	22,000	—	—	—	—	V4-T1-18
QBGfEP	B, GFEP	15-40	1	120	—	—	10,000	—	—	—	—	—	V4-T1-18
QBGfEP	B, GFEP	15-50	2	120/240	—	—	—	10,000	—	—	—	—	V4-T1-18
QBHGfEP	B, GFEP	15-30	1	120	—	—	22,000	—	—	—	—	—	V4-T1-18
QBHGfEP	B, GFEP	15-30	2	120/240	—	—	22,000	22,000	—	—	—	—	V4-T1-18
QC	C	10-70	1	120/240	24, 48, 62.5	10a, 11a, 12a	—	10,000	—	5000	③	—	V4-T1-41
QC	C	10-100	2	120/240	24, 48, 80	10a, 12a	—	10,000	—	5000	5000	5000	V4-T1-41
QC	C	10-100	2, 3, 4	240	—	10b, 11b, 12b	—	—	10,000	—	—	—	V4-T1-41
QCD	C	10-60	1, 2	120/240	24, 48, 62.5	—	10,000	10,000	—	3000	3000	—	V4-T1-23
QCD	C	10-100	2, 3	240	24, 48, 62.5	—	—	10,000	—	3000	3000	—	V4-T1-23
QCF	C	10-60	1, 2	120/240	24, 48, 62.5	—	10,000	10,000	—	3000	3000	—	V4-T1-42

Notes

① QUICKLAG circuit breakers are suitable for application in relative humidity 0-95% noncondensing.

② Two-pole DC interrupting ratings based on two poles connected in series. Not UL listed.

③ 62.5 Vac interrupting rating is 3800 AIC 10-50A and 2500 AIC 55-100A continuous.

Circuit Breaker Type Codes: **P** Plug-In; **B** Bolt-On; **C** Cable-In/Cable-Out; **GF** Ground Fault, 5 mA; **GFEP** Ground Fault, 30 mA.

For Types GHBS, GBHS and BABRP solenoid-operated, remote-controlled circuit breakers, see **Pages V4-T1-31 to V4-T1-36**.

Eaton's QUICKLAG Industrial Circuit Breakers ① Plug-In, Bolt-On, Cable-In/Cable-Out, continued

Circuit Breaker Type	Circuit Breaker Type Code	Continuous Ampere Rating at 40°C	Number of Poles				Federal Spec. W-C-375b	Interrupting Ratings rms Symmetrical Amperes						Page Number
								Vac Ratings			Vdc Ratings ②			
				Vac	Vdc		120	120/240	240	24-48	62.5	80		
QCF	C	15-20	1, 2	120/240	24, 48, 62.5	—	22,000	—	—	3000	3000	—	V4-T1-27	
QCF	C	15-30	2, 3	240	24, 48, 62.5	—	—	10,000	—	3000	3000	—	V4-T1-27	
QCR	C	10-60	1, 2	120/240	24, 48, 62.5	—	10,000	10,000	—	3000	3000	—	V4-T1-27	
QCR	C	15-20	1, 2	120/240	24, 48, 62.5	—	22,000	—	—	3000	3000	—	V4-T1-27	
QCR	C	15-30	2, 3	240	24, 48, 62.5	—	—	10,000	—	3000	3000	—	V4-T1-27	
QCHW	C	15-70	1	120/240	24, 48, 62.5	14a	—	22,000	—	5000	③	—	V4-T1-22	
QCHW	C	15-100	2	120/240	24, 48, 80	14a	—	22,000	—	5000	5000	5000	V4-T1-22	
QCHW	C	15-100	2, 3	240	—	14b	—	—	22,000	—	—	—	V4-T1-22	
QHCX	C	15-70	1	120/240	24, 48, 62.5	—	—	42,000	—	5000	③	—	V4-T1-22	
QHCX	C	15-100	2	120/240	24, 48, 80	—	—	42,000	—	5000	5000	5000	V4-T1-22	
QHCX	C	15-100	3	240	—	—	—	—	42,000	—	—	—	V4-T1-22	
QHCW	C	15-30	1	120/240	24, 48, 62.5	15a	—	65,000	—	5000	③	—	V4-T1-22	
QHCW	C	15-30	2	120/240	24, 48, 80	15a	—	65,000	—	5000	5000	5000	V4-T1-22	
QHCW	C	15-20	3	240	—	15b	—	—	65,000	—	—	—	V4-T1-22	
QCGF	C, GF	15-40	1	120	—	—	10,000	—	—	—	—	—	V4-T1-29	
QCGF	C, GF	15-50	2	120/240	—	—	—	10,000	—	—	—	—	V4-T1-29	
QCHGF	C, GF	15-30	1	120	—	—	22,000	—	—	—	—	—	V4-T1-29	
QCHGF	C, GF	15-30	2	120/240	—	—	—	22,000	—	—	—	—	V4-T1-29	
QCGFEP	C, GFEP	15-40	1	120	—	—	10,000	—	—	—	—	—	V4-T1-29	
QCGFEP	C, GFEP	15-50	2	120/240	—	—	—	10,000	—	—	—	—	V4-T1-29	
QCHGFEP	C, GFEP	15-30	1	120	—	—	22,000	—	—	—	—	—	V4-T1-29	
QCHGFEP	C, GFEP	15-30	2	120/240	—	—	—	22,000	—	—	—	—	V4-T1-29	

Notes

① QUICKLAG circuit breakers are suitable for application in relative humidity 0–95% noncondensing.

② Two-pole DC interrupting ratings based on two poles connected in series. Not UL listed.

③ 62.5 Vac interrupting rating is 3800 AIC 10–50A and 2500 AIC 55–100A continuous.

Circuit Breaker Type Codes: **P** Plug-In; **B** Bolt-On; **C** Cable-In/Cable-Out; **GF** Ground Fault, 5 mA; **GFEP** Ground Fault, 30 mA.

For Types GHBS, GBHS and BABRP solenoid-operated, remote-controlled circuit breakers, see **Pages V4-T1-31 to V4-T1-36**.

QUICKLAG Type HQP Single-Pole



Contents

Description	Page
Quick Reference	V4-T1-2
QUICKLAG Plug-On Types HQP, QPHW, QHPX, QHPW Product Selection	V4-T1-6
Dimensions	V4-T1-7
QUICKLAG Plug-On Ground Fault and Equipment Protectors, Types QPGF, QPHGF, QPGFEP, QPHGFEP Bolt-On Types BAB, QBHW, HBAX, HBAW	V4-T1-8
Bolt-On Arc Fault Circuit Interrupter Types QBAF, QBCAF	V4-T1-11
Bolt-On Ground Fault and Equipment Protectors, Types QBGF, QBHGF, QBGFEP, QBHGFEP	V4-T1-14
Cable-In/Cable-Out Types QC, QCD, QCHW, QHCX, QHCW	V4-T1-17
Cable-In/Cable-Out, 1/2-Inch Wide, Types QCR, QCF, QCRH, QCFH	V4-T1-20
Cable-In/Cable-Out Ground Fault and Equipment Protectors, Types QCGF, QCHGF, QCGFEP, QCHGFEP Solenoid-Operated, Remote-Controlled Latching Types BABRP, BABRSP, BRRP and CLRP	V4-T1-28
Solenoid Operator—Remote Controlled Latching for Type GHBS, GBHS and GHQRSP Breakers.	V4-T1-31
International Rated Types HQP, BA, QC, GFMB, GFXBC Special Application Breakers, Types HQP, BA, QC	V4-T1-34
	V4-T1-37
	V4-T1-40

QUICKLAG Plug-On Types HQP, QPHW, QHPX, QHPW

Product Description

- All products 15–100A are HACR rated
- Switching duty rated for 120 Vac fluorescent light applications

Standards and Certifications

- Built and listed to UL 489
- All products UL and CSA® listed



Product Selection

QUICKLAG Type HQP Single-Pole



QUICKLAG Type: HQP 10,000A Interrupting Capacity Thermal-Magnetic Breakers

Continuous Ampere Rating at 40°C	Single-Pole 120/240 Vac Catalog Number	Two-Pole 120/240 Vac Catalog Number	Two-Pole 240 Vac Catalog Number	Three-Pole 240 Vac Catalog Number
10	HQP1010	HQP2010	—	HQP3010H ^③
15	HQP1015 ^{①②}	HQP2015	HQP2015H	HQP3015H
20	HQP1020 ^{①②}	HQP2020	HQP2020H	HQP3020H
25	HQP1025	HQP2025	HQP2025H	HQP3025H
30	HQP1030	HQP2030	HQP2030H	HQP3030H
35	HQP1035	HQP2035	HQP2035H	HQP3035H
40	HQP1040	HQP2040	HQP2040H	HQP3040H
45	HQP1045	HQP2045	HQP2045H	HQP3045H
50	HQP1050	HQP2050	HQP2050H	HQP3050H
55	HQP1055	HQP2055	HQP2055H	HQP3055H
60	HQP1060	HQP2060	HQP2060H	HQP3060H
70	HQP1070	HQP2070	HQP2070H	HQP3070H
80	—	HQP2080	HQP2080H	HQP3080H
90	—	HQP2090	HQP2090H	HQP3090H
100	HQP1100	HQP2100	HQP2100H	HQP3100H
110	—	HQP2110	—	—
125	—	HQP2125	—	—
150	—	HQP2150	—	—

QUICKLAG Type: HQP Non-Automatic Switches

Continuous Ampere Rating at 40°C	Single-Pole 120/240 Vac Catalog Number	Two-Pole 120/240 Vac Catalog Number	Two-Pole 240 Vac Catalog Number	Three-Pole 240 Vac Catalog Number
50	HQP1050N	—	HQP2050N	HQP3050N
60	HQP1060N	—	HQP2060N	HQP3060N
100	HQP1100N	—	HQP2100N	HQP3100N

QUICKLAG Type: QPHW 22,000A Interrupting Capacity Thermal-Magnetic Breakers

Continuous Ampere Rating at 40°C	Single-Pole 120/240 Vac Catalog Number	Two-Pole 120/240 Vac Catalog Number	Two-Pole 240 Vac Catalog Number	Three-Pole 240 Vac Catalog Number
15	QPHW1015 ^①	QPHW2015	QPHW2015H	QPHW3015H
20	QPHW1020 ^①	QPHW2020	QPHW2020H	QPHW3020H
25	QPHW1025	QPHW2025	QPHW2025H	QPHW3025H
30	QPHW1030	QPHW2030	QPHW2030H	QPHW3030H
35	QPHW1035	QPHW2035	QPHW2035H	QPHW3035H
40	QPHW1040	QPHW2040	QPHW2040H	QPHW3040H
45	QPHW1045	QPHW2045	QPHW2045H	QPHW3045H
50	QPHW1050	QPHW2050	QPHW2050H	QPHW3050H
55	QPHW1055	QPHW2055	QPHW2055H	QPHW3055H
60	QPHW1060	QPHW2060	QPHW2060H	QPHW3060H
70	QPHW1070	QPHW2070	QPHW2070H	QPHW3070H
80	—	QPHW2080	QPHW2080H	QPHW3080H
90	—	QPHW2090	QPHW2090H	QPHW3090H
100	—	QPHW2100	QPHW2100H	QPHW3100H
110	—	QPHW2110	—	—
125	—	QPHW2125	—	—

Notes

- ① Switching duty rated for 120 Vac fluorescent light applications.
- ② For special low-magnetic breaker, order **HQP1015L1** or **HQP1020L1**.
- ③ Not UL listed.

QUICKLAG Type: QHPX 42,000A Interrupting Capacity Thermal-Magnetic Breakers

Continuous Ampere Rating at 40°C	Single-Pole 120/240 Vac Catalog Number	Two-Pole 120/240 Vac Catalog Number	Two-Pole 240 Vac Catalog Number	Three-Pole 240 Vac Catalog Number
15	QHPX1015 ①	QHPX2015	—	QHPX3015H
20	QHPX1020 ①	QHPX2020	—	QHPX3020H
25	QHPX1025	QHPX2025	—	QHPX3025H
30	QHPX1030	QHPX2030	—	QHPX3030H
35	QHPX1035	QHPX2035	—	QHPX3035H
40	QHPX1040	QHPX2040	—	QHPX3040H
45	QHPX1045	QHPX2045	—	QHPX3045H
50	QHPX1050	QHPX2050	—	QHPX3050H
55	QHPX1055	QHPX2055	—	QHPX3055H
60	QHPX1060	QHPX2060	—	QHPX3060H
70	QHPX1070	QHPX2070	—	QHPX3070H
80	—	QHPX2080	—	QHPX3080H
90	—	QHPX2090	—	QHPX3090H
100	—	QHPX2100	—	QHPX3100H

QUICKLAG Type: QHPW 65,000A Interrupting Capacity Thermal-Magnetic Breakers

Continuous Ampere Rating at 40°C	Single-Pole 120/240 Vac Catalog Number	Two-Pole 120/240 Vac Catalog Number	Two-Pole 240 Vac Catalog Number	Three-Pole 240 Vac Catalog Number
15	QHPW1015 ①	QHPW2015	—	QHPW3015H
20	QHPW1020 ①	QHPW2020	—	QHPW3020H
25	QHPW1025	QHPW2025	—	—
30	QHPW1030	QHPW2030	—	—

Dimensions

Approximate Dimensions in Inches (mm)

Shipping Data

Number of Poles	Carton Quantity	Approximate Weight Lbs (kg)	Dimensions
1	24	9.00 (4.1)	12.50 x 7.50 x 5.00 (317.5 x 190.5 x 127.0)
2	12	9.00 (4.1)	12.50 x 7.50 x 5.00 (317.5 x 190.5 x 127.0)
3	8	9.00 (4.1)	12.50 x 7.50 x 5.00 (317.5 x 190.5 x 127.0)

Note

① Switching duty rated for 120 Vac fluorescent light applications.

QUICKLAG Type QPGF Single-Pole Ground Fault Circuit Breaker



Contents

<i>Description</i>	<i>Page</i>
Quick Reference	V4-T1-2
QUICKLAG Plug-On Types HQP, QPHW, QHPX, QHPW	V4-T1-5
QUICKLAG Plug-On Ground Fault and Equipment Protectors, Types QPGF, QPHGF, QPGFEP, QPHGFEP	
Product Selection	V4-T1-9
Wiring Diagram	V4-T1-10
Dimensions	V4-T1-10
Bolt-On Types BAB, QBHW, HBAX, HBAW	V4-T1-11
Bolt-On Arc Fault Circuit Interrupter Types QBAF, QBCAF	V4-T1-14
Bolt-On Ground Fault and Equipment Protectors, Types QBGF, QBHGF, QBGFEP, QBHGFEP	V4-T1-17
Cable-In/Cable-Out Types QC, QCD, QCHW, QHCX, QHCW	V4-T1-20
Cable-In/Cable-Out, 1/2-Inch Wide, Types QCR, QCF, QCRH, QCFH	V4-T1-24
Cable-In/Cable-Out Ground Fault and Equipment Protectors, Types QCGF, QCHGF, QCGFEP, QCHGFEP	V4-T1-28
Solenoid-Operated, Remote-Controlled Latching Types BABRP, BABRSP, BRRP and CLRP.	V4-T1-31
Solenoid Operator—Remote Controlled Latching for Type GHBS, GBHS and GHORSP Breakers.	V4-T1-34
International Rated Types HQP, BA, QC, GFMB, GFXBC	V4-T1-37
Special Application Breakers, Types HQP, BA, QC	V4-T1-40

QUICKLAG Plug-On Ground Fault and Equipment Protectors, Types QPGF, QPHGF, QPGFEP, QPHGFEP

Product Description

QUICKLAG Ground Fault Circuit Breakers, Class A GFCI

- 5 mA trip sensitivity

QUICKLAG Ground Fault Equipment Protectors

- 30 mA trip sensitivity

Standards and Certifications

- Built and listed to UL 489

QUICKLAG Ground Fault Circuit Breakers, Class A GFCI

- Built and tested to UL 943

QUICKLAG Ground Fault Equipment Protectors

- Built and listed to UL 1053



Product Selection

QUICKLAG Type QPGF Single-Pole



Ground Fault Circuit Breakers—5 mA Sensitivity QUICKLAG Type: QPGF 10,000A Interrupting Capacity Thermal-Magnetic Breakers

Continuous Ampere Rating at 40°C	Single-Pole	Two-Pole
	120 Vac Catalog Number	120/240 Vac Catalog Number
15	QPGF1015	QPGF2015
20	QPGF1020	QPGF2020
25	QPGF1025	QPGF2025
30	QPGF1030	QPGF2030
40	QPGF1040	QPGF2040
50	—	QPGF2050

QUICKLAG Type: QPHGF 22,000A Interrupting Capacity Thermal-Magnetic Breakers

Continuous Ampere Rating at 40°C	Single-Pole	Two-Pole
	120 Vac Catalog Number	120/240 Vac Catalog Number
15	QPHGF1015	QPHGF2015
20	QPHGF1020	QPHGF2020
25	QPHGF1025	QPHGF2025
30	QPHGF1030	QPHGF2030

Ground Fault Equipment Breakers—30 mA Sensitivity QUICKLAG Type: QPGFEP 10,000A Interrupting Capacity Thermal-Magnetic Breakers

Continuous Ampere Rating at 40°C	Single-Pole	Two-Pole
	120 Vac Catalog Number	120/240 Vac Catalog Number
15	QPGFEP1015	QPGFEP2015
20	QPGFEP1020	QPGFEP2020
25	QPGFEP1025	QPGFEP2025
30	QPGFEP1030	QPGFEP2030
40	QPGFEP1040	QPGFEP2040
50	—	QPGFEP2050

QUICKLAG Type: QPHGFEP 22,000A Interrupting Capacity Thermal-Magnetic Breakers

Continuous Ampere Rating at 40°C	Single-Pole	Two-Pole
	120 Vac Catalog Number	120/240 Vac Catalog Number
15	QPHGFEP1015	QPHGFEP2015
20	QPHGFEP1020	QPHGFEP2020
25	QPHGFEP1025	QPHGFEP2025
30	QPHGFEP1030	QPHGFEP2030

Special Application Ground Fault Circuit Protectors—5 mA Sensitivity QUICKLAG Type: QPGF 10,000A Interrupting Capacity with Bell Alarm (W1) or Auxiliary Switch (W2)

Continuous Ampere Rating at 40°C	Single-Pole	Two-Pole
	120 Vac Catalog Number	120/240 Vac Catalog Number
15	QPGF1015W1	QPGF2015W1
20	QPGF1020W1	QPGF2020W1
25	QPGF1025W1	QPGF2025W1
30	QPGF1030W1	QPGF2030W1
40	—	QPGF2040W1
50	—	QPGF2050W1
15	QPGF1015W2	—
20	QPGF1020W2	—
25	QPGF1025W2	—
30	QPGF1030W2	—

Special Application Ground Fault Circuit Protectors—30 mA Sensitivity QUICKLAG Type: QPGFEP 10,000A Interrupting Capacity with Bell Alarm (W1) or Auxiliary Switch (W2)

Continuous Ampere Rating at 40°C	Single-Pole	Two-Pole
	120 Vac Catalog Number	120/240 Vac Catalog Number
15	QPGFEP1015W1	QPGFEP2015W1
20	QPGFEP1020W1	QPGFEP2020W1
25	QPGFEP1025W1	QPGFEP2025W1
30	QPGFEP1030W1	QPGFEP2030W1
40	—	QPGFEP2040W1
50	—	QPGFEP2050W1
15	QPGFEP1015W2	—
20	QPGFEP1020W2	—
25	QPGFEP1025W2	—
30	QPGFEP1030W2	—

Wiring Diagram

Bell Alarm and Auxiliary Contact Schematic



Single-throw double-pole contacts are UL and CSA listed for 5A at 250 Vac.

Bell Alarm (W1)—contacts change state when breaker trips.

Auxiliary Switch (W2)—contacts change state when breaker is opened (or tripped) or closed.

14-inch (355.6 mm) long 18 AWG pigtail wire leads provided.

Dimensions

Approximate Dimensions in Inches (mm)

Shipping Data

Number of Poles	Carton Quantity	Approximate Weight Lbs (kg)	Dimensions
1	24	11.00 (5.0)	12.50 x 6.50 x 5.00 (317.5 x 165.1 x 127.0)
2	5	5.00 (2.3)	15.50 x 6.00 x 4.50 (393.7 x 152.4 x 114.3)

Note

Shipped individually or in carton quantities.

QUICKLAG Type BAB Single-Pole

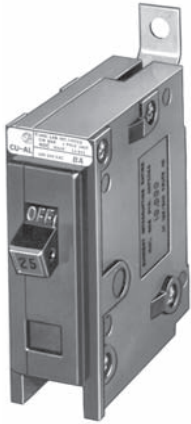

Contents

<i>Description</i>	<i>Page</i>
Quick Reference	V4-T1-2
QUICKLAG Plug-On Types HQP, QPHW, QHPX, QHPW	V4-T1-5
QUICKLAG Plug-On Ground Fault and Equipment Protectors, Types QPGF, QPHGF, QPGFEP, QPHGFEP	V4-T1-8
Bolt-On Types BAB, QBHW, HBAX, HBAW	
Product Selection	V4-T1-12
Dimensions	V4-T1-13
Bolt-On Arc Fault Circuit Interrupter Types	
QBAF, QBCAF	V4-T1-14
Bolt-On Ground Fault and Equipment Protectors, Types QBGF, QBHGF, QBGFEP, QBHGFEP	V4-T1-17
Cable-In/Cable-Out Types QC, QCD, QCHW, QHCX, QHCW	V4-T1-20
Cable-In/Cable-Out, 1/2-Inch Wide, Types QCR, QCF, QCRH, QCFH	V4-T1-24
Cable-In/Cable-Out Ground Fault and Equipment Protectors, Types QCGF, QCHGF, QCGFEP, QCHGFEP	V4-T1-28
Solenoid-Operated, Remote-Controlled Latching Types BABRP, BABRSP, BRRP and CLRP	V4-T1-31
Solenoid Operator—Remote Controlled Latching for Type GHBS, GBHS and GHQRSP Breakers.	V4-T1-34
International Rated Types HQP, BA, QC, GFMB, GFXBC	V4-T1-37
Special Application Breakers, Types HQP, BA, QC.	V4-T1-40

Bolt-On Types BAB, QBHW, HBAX, HBAW

Product Description

- All products 15–100A are HACR rated
- Switching duty rated for 120 Vac fluorescent light applications

Standards and Certifications

- Built and listed to UL 489
- All products UL and CSA listed



Product Selection

QUICKLAG Type BAB
Single-Pole

QUICKLAG Type: BA 10,000A Interrupting Capacity Thermal-Magnetic Breakers

Continuous Ampere Rating at 40°C	Single-Pole 120/240 Vac Catalog Number	Two-Pole 120/240 Vac Catalog Number	Two-Pole 240 Vac Catalog Number	Three-Pole 240 Vac Catalog Number
10	BAB1010	BAB2010	BAB2010H ③	BAB3010H ③
15	BAB1015 ①②	BAB2015	BAB2015H	BAB3015H
20	BAB1020 ①②	BAB2020	BAB2020H	BAB3020H
25	BAB1025	BAB2025	BAB2025H	BAB3025H
30	BAB1030	BAB2030	BAB2030H	BAB3030H
35	BAB1035	BAB2035	BAB2035H	BAB3035H
40	BAB1040	BAB2040	BAB2040H	BAB3040H
45	BAB1045	BAB2045	BAB2045H	BAB3045H
50	BAB1050	BAB2050	BAB2050H	BAB3050H
55	BAB1055	BAB2055	BAB2055H	BAB3055H
60	BAB1060	BAB2060	BAB2060H	BAB3060H
70	BAB1070	BAB2070	BAB2070H	BAB3070H
80	—	BAB2080	BAB2080H	BAB3080H
90	—	BAB2090	BAB2090H	BAB3090H
100	BAB1100	BAB2100	BAB2100H	BAB3100H
110	—	BAB2110	—	—
125	—	BAB2125	—	—

QUICKLAG Type: BA Non-Automatic Switches

Continuous Ampere Rating at 40°C	Single-Pole 120/240 Vac Catalog Number	Two-Pole 120/240 Vac Catalog Number	Two-Pole 240 Vac Catalog Number	Three-Pole 240 Vac Catalog Number
50	BAB1050N	—	BAB2050N	BAB3050N
60	BAB1060N	—	BAB2060N	BAB3060N
100	BAB1100N	—	BAB2100N	BAB3100N

QUICKLAG Type: QBHW 22,000A Interrupting Capacity Thermal-Magnetic Breakers

Continuous Ampere Rating at 40°C	Single-Pole 120/240 Vac Catalog Number	Two-Pole 120/240 Vac Catalog Number	Two-Pole 240 Vac Catalog Number	Three-Pole 240 Vac Catalog Number
15	QBHW1015 ①	QBHW2015	QBHW2015H	QBHW3015H
20	QBHW1020 ①	QBHW2020	QBHW2020H	QBHW3020H
25	QBHW1025	QBHW2025	QBHW2025H	QBHW3025H
30	QBHW1030	QBHW2030	QBHW2030H	QBHW3030H
35	QBHW1035	QBHW2035	QBHW2035H	QBHW3035H
40	QBHW1040	QBHW2040	QBHW2040H	QBHW3040H
45	QBHW1045	QBHW2045	QBHW2045H	QBHW3045H
50	QBHW1050	QBHW2050	QBHW2050H	QBHW3050H
55	QBHW1055	QBHW2055	QBHW2055H	QBHW3055H
60	QBHW1060	QBHW2060	QBHW2060H	QBHW3060H
70	QBHW1070	QBHW2070	QBHW2070H	QBHW3070H
80	—	QBHW2080	QBHW2080H	QBHW3080H
90	—	QBHW2090	QBHW2090H	QBHW3090H
100	—	QBHW2100	QBHW2100H	QBHW3100H
110	—	QBHW2110	—	—
125	—	QBHW2125	—	—

Notes

- ① Switching duty rated for 120 Vac fluorescent light applications.
- ② For special low-magnetic breaker, order **BAB1015L1** or **BAB1020L1**.
- ③ Not UL listed.

QUICKLAG Type: HBAX 42,000A Interrupting Capacity Thermal-Magnetic Breakers

Continuous Ampere Rating at 40°C	Single-Pole 120/240 Vac Catalog Number	Two-Pole 120/240 Vac Catalog Number	Two-Pole 240 Vac Catalog Number	Three-Pole 240 Vac Catalog Number
15	HBAX1015 ^①	HBAX2015	—	HBAX3015H
20	HBAX1020 ^①	HBAX2020	—	HBAX3020H
25	HBAX1025	HBAX2025	—	HBAX3025H
30	HBAX1030	HBAX2030	—	HBAX3030H
35	HBAX1035	HBAX2035	—	HBAX3035H
40	HBAX1040	HBAX2040	—	HBAX3040H
45	HBAX1045	HBAX2045	—	HBAX3045H
50	HBAX1050	HBAX2050	—	HBAX3050H
55	HBAX1055	HBAX2055	—	HBAX3055H
60	HBAX1060	HBAX2060	—	HBAX3060H
70	HBAX1070	HBAX2070	—	HBAX3070H
80	—	HBAX2080	—	HBAX3080H
80	—	HBAX2080	—	HBAX3080H
90	—	HBAX2090	—	HBAX3090H
100	—	HBAX2100	—	HBAX3100H

QUICKLAG Type: HBAW 65,000A Interrupting Capacity Thermal-Magnetic Breakers

Continuous Ampere Rating at 40°C	Single-Pole 120/240 Vac Catalog Number	Two-Pole 120/240 Vac Catalog Number	Two-Pole 240 Vac Catalog Number	Three-Pole 240 Vac Catalog Number
15	HBAW1015 ^①	HBAW2015	—	HBAW3015H
20	HBAW1020 ^①	HBAW2020	—	HBAW3020H
25	HBAW1025	HBAW2025	—	—
30	HBAW1030	HBAW2030	—	—

Dimensions

Approximate Dimensions in Inches (mm)

Shipping Data

Number of Poles	Carton Quantity	Approximate Weight Lbs (kg)	Dimensions
1	24	9.00 (4.1)	12.50 x 7.50 x 5.00 (317.5 x 190.5 x 127.0)
2	12	9.00 (4.1)	12.50 x 7.50 x 5.00 (317.5 x 190.5 x 127.0)
3	8	9.00 (4.1)	12.50 x 7.50 x 5.00 (317.5 x 190.5 x 127.0)

Note

^① Switching duty rated for 120 Vac fluorescent light applications.

Bolt-On Arc Fault Circuit Interrupter QUICKLAG Types QBAF, QBCAF



Contents

<i>Description</i>	<i>Page</i>
Quick Reference	V4-T1-2
QUICKLAG Plug-On Types HQP, QPHW, QHPX, QHPW	V4-T1-5
QUICKLAG Plug-On Ground Fault and Equipment Protectors, Types QPGF, QPHGF, QPGFEP, QPHGFEP	V4-T1-8
Bolt-On Types BAB, QBHW, HBAX, HBAW	V4-T1-11
Bolt-On Arc Fault Circuit Interrupter Types QBAF, QBCAF	
Product Selection	V4-T1-15
Wiring Diagrams	V4-T1-16
Bolt-On Ground Fault and Equipment Protectors, Types QBGF, QBHGF, QBGFEP, QBHGFEP	V4-T1-17
Cable-In/Cable-Out Types QC, QCD, QCHW, QHCX, QHCW	V4-T1-20
Cable-In/Cable-Out, 1/2-Inch Wide, Types QCR, QCF, QCRH, QCFH	V4-T1-24
Cable-In/Cable-Out Ground Fault and Equipment Protectors, Types QCGF, QCHGF, QCGFEP, QCHGFEP	V4-T1-28
Solenoid-Operated, Remote-Controlled Latching Types BABRP, BABRSP, BRRP and CLRP.	V4-T1-31
Solenoid Operator—Remote Controlled Latching for Type GHBS, GBHS and GHORSP Breakers	V4-T1-34
International Rated Types HQP, BA, QC, GFMB, GFXBC	V4-T1-37
Special Application Breakers, Types HQP, BA, QC . . .	V4-T1-40

Bolt-On Arc Fault Circuit Interrupter Types QBAF, QBCAF

Product Description

- All products HACR rated

Features, Benefits and Functions

- 10 and 22 kAIC rating at 120V and 120/240V
- Single-pole AFCI
- HID ratings for HID (High Intensity Discharge) lighting
- All models are HACR rated

Standards and Certifications

- Built and listed to UL 489
- UL File E7819 for QBAF



Product Selection

QBCAF and QBAF Type AFCIs

Effective immediately, Eaton AFCIs are available for use in Sumter panels with a 22 kAIC rating. This higher rated breaker will allow us to win jobs where AFCIs are specified at higher than 10 kAIC. This breaker provides standard thermal-

magnetic protection of branch circuits. This product will have the same form, fit and function of the current bolt-on AFCI (QBCAF and QBAF Type). Product scope is below. These breakers are in Bid Manager™ for Pow-R-Line 1a, Pow-R-Line 1a-LX,

Pow-R-Line 3a and Pow-R-Line 4a panelboards. For series rated combinations, continue to use the less expensive 10 kAIC QBCAF and QBAF offerings.

Breakers can also be ordered from Vista.

QBHCAF



1-Inch (25.4 mm) Wide Bolt-On Arc Fault Circuit Interrupter

Poles	kAIC Rating	Ampere Rating	Configuration	Catalog Number
Type QBCAF Combination AFCI				
Single-pole	10 kAIC	15	Combination AFCI	QBCAF1015
		20	Combination AFCI	QBCAF1020
	22 kAIC	15	Combination AFCI	QBHCAF1015
		20	Combination AFCI	QBHCAF1020
Type QBAF Branch Feeder AFCI				
Single-pole	10 kAIC	15	Branch Feeder AFCI	QBAF1015
		20	Branch Feeder AFCI	QBAF1020
	22 kAIC	15	Branch Feeder AFCI	QBHAF1015
		20	Branch Feeder AFCI	QBHAF1020

1

Wiring Diagrams

Single-Pole 120V Load Application Sourced by 120/240 Vac

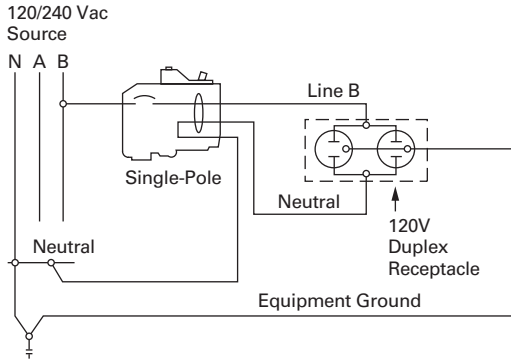

Single-Pole Shared Neutral with Multi-Duplex Receptacle Application

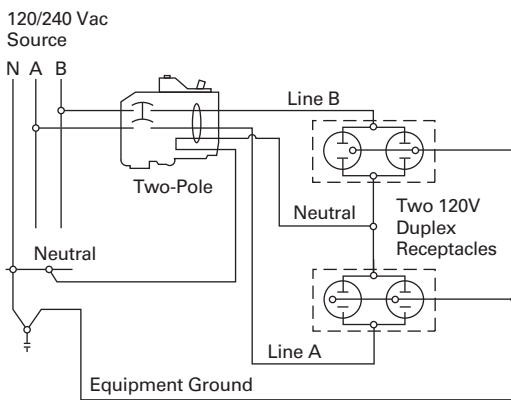

QUICKLAG Type QBGF Single-Pole Ground Fault Circuit Breaker



Bolt-On Ground Fault and Equipment Protectors, Types QBGF, QBHGF, QBGFEP, QBHGFEP

Product Description

QUICKLAG Ground Fault Circuit Breakers, Class A GFCI

- 5 mA trip sensitivity

QUICKLAG Ground Fault Equipment Protectors

- 30 mA trip sensitivity

Standards and Certifications

- Built and tested to UL 489

QUICKLAG Ground Fault Circuit Breakers, Class A GFCI

- Built and tested to UL 943

QUICKLAG Ground Fault Equipment Protectors

- Built and tested to UL 1053



Contents

Description

Page

QUICKLAG Plug-On Types HQP, QPHW, QHPX, QHPW	V4-T1-5
QUICKLAG Plug-On Ground Fault and Equipment Protectors, Types QPGF, QPHGF, QPGFEP, QPHGFEP	V4-T1-8
Bolt-On Types BAB, QBHW, HBAX, HBAW	V4-T1-11
Bolt-On Arc Fault Circuit Interrupter Types QBAF, QBCAF	V4-T1-14
Bolt-On Ground Fault and Equipment Protectors, Types QBGF, QBHGF, QBGFEP, QBHGFEP	V4-T1-18
Product Selection	V4-T1-19
Wiring Diagram	V4-T1-19
Dimensions	V4-T1-19
Cable-In/Cable-Out Types QC, QCD, QCHW, QHCX, QHCW	V4-T1-20
Cable-In/Cable-Out, 1/2-Inch Wide, Types QCR, QCF, QCRH, QCFH	V4-T1-24
Cable-In/Cable-Out Ground Fault and Equipment Protectors, Types QCGF, QCHGF, QCGFEP, QCHGFEP	V4-T1-28
Solenoid-Operated, Remote-Controlled Latching Types BABRP, BABRSP, BRRP and CLRP	V4-T1-31
Solenoid Operator—Remote Controlled Latching for Type GHBS, GBHS and GHQRSP Breakers	V4-T1-34
International Rated Types HQP, BA, QC, GFMB, GFXBC	V4-T1-37
Special Application Breakers, Types HQP, BA, QC	V4-T1-40

Product Selection

QUICKLAG Type QBGF Single-Pole



Ground Fault Circuit Breakers—5 mA Sensitivity QUICKLAG Type: QBGF 10,000A Interrupting Capacity Thermal-Magnetic Breakers

Continuous Ampere Rating at 40°C	Single-Pole	Two-Pole
	120 Vac Catalog Number	120/240 Vac Catalog Number
15	QBGF1015	QBGF2015
20	QBGF1020	QBGF2020
25	QBGF1025	QBGF2025
30	QBGF1030	QBGF2030
40	QBGF1040	QBGF2040
50	—	QBGF2050

QUICKLAG Type: QBHGF 22,000A Interrupting Capacity Thermal-Magnetic Breakers

Continuous Ampere Rating at 40°C	Single-Pole	Two-Pole
	120 Vac Catalog Number	120/240 Vac Catalog Number
15	QBHGF1015	QBHGF2015
20	QBHGF1020	QBHGF2020
25	QBHGF1025	QBHGF2025
30	QBHGF1030	QBHGF2030

Ground Fault Equipment Breakers—30 mA Sensitivity QUICKLAG Type: QBGFEP 10,000A Interrupting Capacity Thermal-Magnetic Breakers

Continuous Ampere Rating at 40°C	Single-Pole	Two-Pole
	120 Vac Catalog Number	120/240 Vac Catalog Number
15	QBGFEP1015	QBGFEP2015
20	QBGFEP1020	QBGFEP2020
25	QBGFEP1025	QBGFEP2025
30	QBGFEP1030	QBGFEP2030
40	QBGFEP1040	QBGFEP2040
50	—	QBGFEP2050

QUICKLAG Type: QBHGFEP 22,000A Interrupting Capacity Thermal-Magnetic Breakers

Continuous Ampere Rating at 40°C	Single-Pole	Two-Pole
	120 Vac Catalog Number	120/240 Vac Catalog Number
15	QBHGFEP1015	QBHGFEP2015
20	QBHGFEP1020	QBHGFEP2020
25	QBHGFEP1025	QBHGFEP2025
30	QBHGFEP1030	QBHGFEP2030

Special Application Ground Fault Circuit Protectors—5 mA Sensitivity QUICKLAG Type: QBGF 10,000A Interrupting Capacity with Bell Alarm (W1) or Auxiliary Switch (W2)

Continuous Ampere Rating at 40°C	Single-Pole	Two-Pole
	120 Vac Catalog Number	120/240 Vac Catalog Number
15	QBGF1015W1	QBGF2015W1
20	QBGF1020W1	QBGF2020W1
25	QBGF1025W1	QBGF2025W1
30	QBGF1030W1	QBGF2030W1
40	—	QBGF2040W1
50	—	QBGF2050W1
15	QBGF1015W2	—
20	QBGF1020W2	—
25	QBGF1025W2	—
30	QBGF1030W2	—

Special Application Ground Fault Circuit Protectors—30 mA Sensitivity QUICKLAG Type: QBGFEP 10,000A Interrupting Capacity with Bell Alarm (W1) or Auxiliary Switch (W2)

Continuous Ampere Rating at 40°C	Single-Pole	Two-Pole
	120 Vac Catalog Number	120/240 Vac Catalog Number
15	QBGFEP1015W1	QBGFEP2015W1
20	QBGFEP1020W1	QBGFEP2020W1
25	QBGFEP1025W1	QBGFEP2025W1
30	QBGFEP1030W1	QBGFEP2030W1
40	—	QBGFEP2040W1
50	—	QBGFEP2050W1
15	QBGFEP1015W2	—
20	QBGFEP1020W2	—
25	QBGFEP1025W2	—
30	QBGFEP1030W2	—

Wiring Diagram

Bell Alarm and Auxiliary Contact Schematic



Single-throw double-pole contacts are UL and CSA listed for 5A at 250 Vac.
 Bell Alarm (W1)—contacts change state when breaker trips.
 Auxiliary Switch (W2)—contacts change state when breaker is opened (or tripped) or closed.
 14-inch (355.6 mm) long 18 AWG pigtail wire leads provided.

Dimensions

Approximate Dimensions in Inches (mm)

Shipping Data

Number of Poles	Approximate Weight Lbs (kg)	Dimensions
1	11.00 (5.0)	12.50 x 6.50 x 5.00 (317.5 x 165.1 x 127.0)
2	5.00 (2.3)	15.50 x 6.00 x 4.50 (393.7 x 152.4 x 114.3)

Note

Shipped individually or in carton quantities.

QUICKLAG Type QC Single-Pole



Contents

<i>Description</i>	<i>Page</i>
Quick Reference	V4-T1-2
QUICKLAG Plug-On Types HQP, QPHW, QHPX, QHPW QUICKLAG Plug-On Ground Fault and Equipment Protectors, Types QPGF, QPHGF, QPGFEP, QPHGFEP	V4-T1-5 V4-T1-8
Bolt-On Types BAB, QBHW, HBAX, HBAW	V4-T1-11
Bolt-On Arc Fault Circuit Interrupter Types QBAF, QBCAF	V4-T1-14
Bolt-On Ground Fault and Equipment Protectors, Types QBGF, QBHGF, QBGFEP, QBHGFEP	V4-T1-17
Cable-In/Cable-Out Types QC, QCD, QCHW, QHCX, QHCW Product Selection	V4-T1-21 V4-T1-23
Dimensions	V4-T1-23
Cable-In/Cable-Out, 1/2-Inch Wide, Types QCR, QCF, QCRH, QCFH	V4-T1-24
Cable-In/Cable-Out Ground Fault and Equipment Protectors, Types QCGF, QCHGF, QCGFEP, QCHGFEP	V4-T1-28
Solenoid-Operated, Remote-Controlled Latching Types BABRP, BABRSP, BRRP and CLRP.	V4-T1-31
Solenoid Operator—Remote Controlled Latching for Type GHBS, GBHS and GHORSP Breakers	V4-T1-34
International Rated Types HQP, BA, QC, GFMB, GFXBC	V4-T1-37
Special Application Breakers, Types HQP, BA, QC . . .	V4-T1-40

Cable-In/Cable-Out Types QC, QCD, QCHW, QHCX, QHCW

Product Description

- All products 10–100A are HACR rated
- Switching duty rated for 120 Vac fluorescent light applications only

Standards and Certifications

- Built and listed to UL 489
- All products UL and CSA listed



Product Selection

QUICKLAG
Type QC Single-Pole



QUICKLAG Type: QC 10,000A Interrupting Capacity Thermal-Magnetic Breakers

Continuous Ampere Rating at 40°C	Single-Pole 120/240 Vac Catalog Number	Two-Pole 120/240 Vac Catalog Number	Two-Pole 240 Vac Catalog Number	Three-Pole 240 Vac Catalog Number	Four-Pole 240 Vac Catalog Number
5	QC1005 ①	QC2005 ①	—	—	—
10	QC1010	QC2010	QC2010H ①	QC3010H ①	—
15	QC1015 ②	QC2015	QC2015H	QC3015H	QC4015H
20	QC1020 ②	QC2020	QC2020H	QC3020H	QC4020H
25	QC1025	QC2025	QC2025H	QC3025H	QC4025H
30	QC1030	QC2030	QC2030H	QC3030H	QC4030H
35	QC1035	QC2035	QC2035H	QC3035H	QC4035H
40	QC1040	QC2040	QC2040H	QC3040H	QC4040H
45	QC1045	QC2045	QC2045H	QC3045H	QC4045H
50	QC1050	QC2050	QC2050H	QC3050H	QC4050H
55	QC1055	QC2055	QC2055H	QC3055H	QC4055H
60	QC1060	QC2060	QC2060H	QC3060H	QC4060H
70	QC1070	QC2070	QC2070H	QC3070H	QC4070H
70	—	QC2080	QC2080H	QC3080H	QC4080H
90	—	QC2090	QC2090H	QC3090H	QC4090H
100	QC1100	QC2100	QC2100H	QC3100H	QC4100H

QUICKLAG Type: QC Non-Automatic Switches

Continuous Ampere Rating at 40°C	Single-Pole 120/240 Vac Catalog Number	Two-Pole 120/240 Vac Catalog Number	Two-Pole 240 Vac Catalog Number	Three-Pole 240 Vac Catalog Number	Four-Pole 240 Vac Catalog Number
50	QC1050N	—	QC2050N	QC3050N	—
60	QC1060N	—	QC2060N	QC3060N	—
100	QC1100N	—	QC2100N	QC3100N	—

Notes

① Not UL listed.

② Switching duty rated for 120 Vac fluorescent light applications only.

For special low-magnetic breaker, order **QC1015L1** or **QC1020L1**. Non-automatic switches, see **Page V4-T1-42**.

QUICKLAG Type: QCHW 22,000A Interrupting Capacity Thermal-Magnetic Breakers

Continuous Ampere Rating at 40°C	Single-Pole 120/240 Vac Catalog Number	Two-Pole 120/240 Vac Catalog Number	Two-Pole 240 Vac Catalog Number	Three-Pole 240 Vac Catalog Number	Four-Pole 240 Vac Catalog Number
15	QCHW1015 ①	QCHW2015	QCHW2015H	QCHW3015H	QCHW4015H
20	QCHW1020 ①	QCHW2020	QCHW2020H	QCHW3020H	QCHW4020H
25	QCHW1025	QCHW2025	QCHW2025H	QCHW3025H	QCHW4025H
30	QCHW1030	QCHW2030	QCHW2030H	QCHW3030H	QCHW4030H
35	QCHW1035	QCHW2035	QCHW2035H	QCHW3035H	QCHW4035H
40	QCHW1040	QCHW2040	QCHW2040H	QCHW3040H	QCHW4040H
45	QCHW1045	QCHW2045	QCHW2045H	QCHW3045H	QCHW4045H
50	QCHW1050	QCHW2050	QCHW2050H	QCHW3050H	QCHW4050H
55	QCHW1055	QCHW2055	QCHW2055H	QCHW3055H	QCHW4055H
60	QCHW1060	QCHW2060	QCHW2060H	QCHW3060H	QCHW4060H
70	QCHW1070	QCHW2070	QCHW2070H	QCHW3070H	QCHW4070H
70	—	QCHW2080	QCHW2080H	QCHW3080H	QCHW4080H
90	—	QCHW2090	QCHW2090H	QCHW3090H	QCHW4090H
100	—	QCHW2100	QCHW2100H	QCHW3100H	QCHW4100H

QUICKLAG Type: QHCX 42,000A Interrupting Capacity Thermal-Magnetic Breakers

Continuous Ampere Rating at 40°C	Single-Pole 120/240 Vac Catalog Number	Two-Pole 120/240 Vac Catalog Number	Two-Pole 240 Vac Catalog Number	Three-Pole 240 Vac Catalog Number	Four-Pole 240 Vac Catalog Number
15	QHCX1015 ①	QHCX2015	—	QHCX3015H	—
20	QHCX1020 ①	QHCX2020	—	QHCX3020H	—
25	QHCX1025	QHCX2025	—	QHCX3025H	—
30	QHCX1030	QHCX2030	—	QHCX3030H	—
35	QHCX1035	QHCX2035	—	QHCX3035H	—
40	QHCX1040	QHCX2040	—	QHCX3040H	—
45	QHCX1045	QHCX2045	—	QHCX3045H	—
50	QHCX1050	QHCX2050	—	QHCX3050H	—
55	QHCX1055	QHCX2055	—	QHCX3055H	—
60	QHCX1060	QHCX2060	—	QHCX3060H	—
70	QHCX1070	QHCX2070	—	QHCX3070H	—
70	—	QHCX2080	—	QHCX3080H	—
90	—	QHCX2090	—	QHCX3090H	—
100	—	QHCX2100	—	QHCX3100H	—

QUICKLAG Type: QHCW 65,000A Interrupting Capacity Thermal-Magnetic Breakers

Continuous Ampere Rating at 40°C	Single-Pole 120/240 Vac Catalog Number	Two-Pole 120/240 Vac Catalog Number	Two-Pole 240 Vac Catalog Number	Three-Pole 240 Vac Catalog Number	Four-Pole 240 Vac Catalog Number
15	QHCW1015 ①	QHCW2015	—	QHCW3015H	—
20	QHCW1020 ①	QHCW2020	—	QHCW3020H	—
25	QHCW1025	QHCW2025	—	—	—
30	QHCW1030	QHCW2030	—	—	—

Notes

① Switching duty rated for 120 Vac fluorescent light applications only.

Non-automatic switches, see **Page V4-T1-42**.

QUICKLAG Type QCD Miniature Circuit Breakers

QCD breakers are used primarily in HVAC and industrial applications.

- Single-, two- and three-pole options
- Modular construction
- DIN mounted (symmetrical rail 35 x 7.5 DIN/EN 50 022)
- QCD same profile as Type QCR
- Flexible power feed connection: wire size, position
- Same breaker size for entire rating range
- Field mountable accessories: finger shroud proof, quick connect terminals
- Other accessories: jumper unit

QUICKLAG Type QCD Miniature Circuit Breaker



QUICKLAG Type QCD 10,000A Interrupting Capacity Thermal-Magnetic Breakers

Continuous Ampere Rating at 40°C	Single-Pole	Two-Pole	Two-Pole	Three-Pole
	120/240 Vac Catalog Number	120/240 Vac Catalog Number	240 Vac Catalog Number	240 Vac Catalog Number
10	QCD1010	QCD2010	—	—
15	QCD1015	QCD2015	QCD2015H	QCD3015H
20	QCD1020	QCD2020	QCD2020H	QCD3020H
25	QCD1025	QCD2025	QCD2025H	QCD3025H
30	QCD1030	QCD2030	QCD2030H	QCD3030H
35	QCD1035	QCD2035	QCD2035H	QCD3035H
40	QCD1040	QCD2040	QCD2040H	QCD3040H
45	QCD1045	QCD2045	QCD2045H	QCD3045H
50	QCD1050	QCD2050	QCD2050H	QCD3050H
55	QCD1055	QCD2055	QCD2055H	QCD3055H
60	QCD1060	QCD2060	QCD2060H	QCD3060H
70	—	QCD2070	QCD2070H	QCD3070H
80	—	QCD2080	QCD2080H	QCD3080H
90	—	QCD2090	QCD2090H	QCD3090H
100	—	QCD2090	QCD2090H	QCD3100H
	—	QCD2100	QCD2100H	—

QUICKLAG Type QCD Non-Automatic Switches

Continuous Ampere Rating at 40°C	Single-Pole	Two-Pole	Two-Pole	Three-Pole
	120/240 Vac Catalog Number	120/240 Vac Catalog Number	240 Vac Catalog Number	240 Vac Catalog Number
60	—	—	QCD2060NA	—
100	—	—	—	—

Dimensions

Approximate Dimensions in Inches (mm)

Shipping Data

Number of Poles	Carton Quantity	Approximate Weight Lbs (kg)	Dimensions
1	24	9.00 (4.1)	12.50 x 7.50 x 5.00 (317.5 x 190.5 x 127.0)
2	12	9.00 (4.1)	12.50 x 7.50 x 5.00 (317.5 x 190.5 x 127.0)
3	8	9.00 (4.1)	12.50 x 7.50 x 5.00 (317.5 x 190.5 x 127.0)

Cable-In/Cable-Out, 1/2-Inch Wide, Types QCR, QCF, QCRH, QCFH

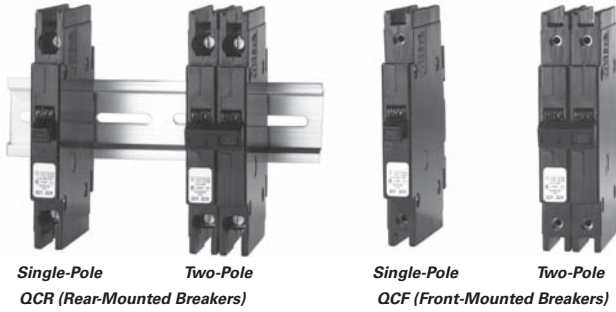

Contents

<i>Description</i>	<i>Page</i>
Quick Reference	V4-T1-2
QUICKLAG Plug-On Types HQP, QPHW, QHPX, QHPW QUICKLAG Plug-On Ground Fault and Equipment Protectors, Types QPGF, QPHGF, QPGFEP, QPHGFEP	V4-T1-5
Bolt-On Types BAB, QBHW, HBAX, HBAW	V4-T1-8
Bolt-On Arc Fault Circuit Interrupter Types QBAF, QBCAF	V4-T1-11
Bolt-On Ground Fault and Equipment Protectors, Types QBGF, QBHGF, QBGFEP, QBHGFEP	V4-T1-14
Cable-In/Cable-Out Types QC, QCD, QCHW, QHCX, QHCW	V4-T1-17
Cable-In/Cable-Out, 1/2-Inch Wide, Types QCR, QCF, QCRH, QCFH Product Selection	V4-T1-20
QCR and QCF Options and Accessories	V4-T1-25
Cable-In/Cable-Out Ground Fault and Equipment Protectors, Types QCGF, QCHGF, QCGFEP, QCHGFEP	V4-T1-28
Solenoid-Operated, Remote-Controlled Latching Types BABRP, BABRSP, BRRP and CLRP.	V4-T1-31
Solenoid Operator—Remote Controlled Latching for Type GHBS, GBHS and GHORSP Breakers	V4-T1-34
International Rated Types HQP, BA, QC, GFMB, GFXBC	V4-T1-37
Special Application Breakers, Types HQP, BA, QC	V4-T1-40

Cable-In/Cable-Out, 1/2-Inch Wide, Types QCR, QCF, QCRH, QCFH

Product Description

Eaton Type QCR circuit breakers have as a standard feature provisions for 35 mm DIN rail rear mounting with a spring-loaded release. Optional clips for individual mounting are available as a separate accessory.

Type QCF have two threaded steel inserts to facilitate front mounting with #6–32 steel screws. The clamp type terminals are accessible from the rear of the breaker so that cables can be accessed without removal of the breaker from the front cover.

Application Description

QCR and QCF circuit breakers are only 1/2-inch (12.7 mm) wide per pole and are excellent for general purpose industrial applications where space savings is required.

Features, Benefits and Functions

- 1/2-inch (12.7 mm) wide per pole
- Cable-in/cable-out
- Black cases with black handles
- Three position handle: ON, Tripped (center), OFF
- Thermal-magnetic protection

Standards and Certifications

- Built and listed to UL 489
- UL File No. E7819
- CSA File No. LR48907
- Type QCR and QCF circuit breakers are UL listed circuit breakers that are suitable for use as branch circuit protectors
- All ratings 15–60A are HACR rated



Product Selection

Cable-In/Cable-Out,
1/2-Inch Wide



QCR Breaker Catalog Numbers ^{①②③④}

Continuous Ampere Rating at 40°C	Single-Pole 120/240 Vac Catalog Number	Two-Pole 120/240 Vac Catalog Number	Two-Pole 240 Vac ^⑤ Catalog Number	Three-Pole Catalog Number
QCR Breaker 10 kAIC Interrupting Ratings				
10	QCR1010	QCR2010	—	—
	QCR1010T	QCR2010T	—	—
	—	QCR2010P	—	—
15	QCR1015 ^⑥	QCR2015	QCR2015H	QCR3015H
	QCR1015T ^⑥	QCR2015T	QCR2015HT	QCR3015HT
	—	QCR2015P	—	—
20	QCR1020 ^⑥	QCR2020	QCR2020H	QCR3020H
	QCR1020T ^⑥	QCR2020T	QCR2020HT	QCR3020HT
	—	QCR2020P	—	—
25	QCR1025	QCR2025	QCR2025H	QCR3025H
	QCR1025T	QCR2025T	QCR2025HT	QCR3025HT
	—	QCR2025P	—	—
30	QCR1030	QCR2030	QCR2030H	QCR3030H
	QCR1030T	QCR2030T	QCR2030HT	QCR3030HT
	—	QCR2030P	—	—
35	QCR1035	QCR2035	—	—
	—	QCR2035P	—	—
40	QCR1040	QCR2040	—	—
	—	QCR2040P	—	—
45	QCR1045	QCR2045	—	—
	—	QCR2045P	—	—
50	QCR1050	QCR2050	—	—
	—	QCR2050P	—	—
55	QCR1055	QCR2055	—	—
	—	QCR2055P	—	—
60 ^⑦	QCR1060	QCR2060	—	—
	—	QCR2060P	—	—
QCR Breaker 22 kAIC Interrupting Ratings				
15	QCRH1015 ^⑥	QCRH2015	—	—
	QCRH1015T ^⑥	QCRH2015T	—	—
20	QCRH1020 ^⑥	QCRH2020	—	—
	QCRH1020T ^⑥	QCRH2020T	—	—

Notes

- ① Standard breaker terminals are box type lugs.
- ② Breakers with **T** Catalog Number Suffix are suitable for line and load side ring terminal connection (#10–32 plus/minus terminal screw provided).
- ③ Breakers with **P** Catalog Number Suffix are suitable for terminating two 10 AWG Quick-Connect Type Terminals per phase on breaker load side.
- ④ Breakers with Shunt Trip (extra pole required on breaker right-hand side) are available on single-, two- and three-pole. Contact the Customer Support Center at 1-800-356-1243.
- ⑤ Breakers with **H** Catalog Suffix have 240 Vac construction.
- ⑥ All 15 and 20A single-pole breakers are SWD (Switching Duty) rated for fluorescent lighting applications.
- ⑦ 60/75°C Cu/Al wire on all ratings except 60A, which requires Cu only conductor.

Cable-In/Cable-Out,
1/2-Inch Wide



QCF Breaker Catalog Numbers ^{①②③}

Continuous Ampere Rating at 40°C	Single-Pole 120/240 Vac	Two-Pole 120/240 Vac	Two-Pole 240 Vac ^④	Three-Pole
	Catalog Number	Catalog Number	Catalog Number	Catalog Number
QCF Breaker 10 kAIC Interrupting Ratings				
10	QCF1010	QCF2010	—	—
	QCF1010T	QCF2010T	—	—
15	QCF1015 ^⑤	QCF2015	QCF2015H	QCF3015H
	QCF1015T ^⑤	QCF2015T	QCF2015HT	QCF3015HT
20	QCF1020 ^⑤	QCF2020	QCF2020H	QCF3020H
	QCF1020T ^⑤	QCF2020T	QCF2020HT	QCF3020HT
25	QCF1025	QCF2025	QCF2025H	QCF3025H
	QCF1025T	QCF2025T	QCF2025HT	QCF3025HT
30	QCF1030	QCF2030	QCF2030H	QCF3030H
	QCF1030T	QCF2030T	QCF2030HT	QCF3030HT
35	QCF1035	QCF2035	—	—
40	QCF1040	QCF2040	—	—
45	QCF1045	QCF2045	—	—
50	QCF1050	QCF2050	—	—
55	QCF1055	QCF2055	—	—
60 ^⑥	QCF1060	QCF2060	—	—
QCF Breaker 22 kAIC Interrupting Ratings				
15	QCFH1015 ^⑤	QCFH2015	—	—
	QCFH1015T ^⑤	QCFH2015T	—	—
20	QCFH1020 ^⑤	QCFH2020	—	—
	QCFH1020T ^⑤	QCFH2020T	—	—

Notes

- ① Standard breaker terminals are box type lugs.
- ② Breakers with **T** Catalog Number Suffix are suitable for line and load side ring terminal connection (#10–32 plus/minus terminal screw provided).
- ③ Breakers with Shunt Trip Attachment (extra pole required on breaker right-hand side) are available. Contact the Customer Support Center.
- ④ Breakers with **H** Catalog Suffix have 240 Vac construction.
- ⑤ All 15 and 20A single-pole breakers are SWD (Switching Duty) rated for fluorescent lighting applications.
- ⑥ 60/75°C Cu/Al wire on all ratings except 60A, which requires Cu only conductor.

QCR and QCF Options and Accessories

QCR and QCF Standard Box Terminals

Factory-installed line and load side breaker terminal to accommodate 14 AWG to 4 AWG wire.

Standard Box Terminals

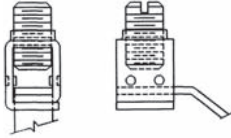

QCR Quick-Connect Terminals

Factory-installed two-prong quick-connect terminal on breaker load side suitable for terminating two 10 AWG wire with insulated slip-on terminals as shown. Line side terminal is the standard type.

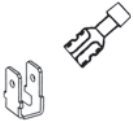

Catalog Suffix "P"

QCR and QCF Ring or Spade Lug Terminals (10 to 30A Ratings Only)

Factory-installed line and load side terminals each equipped with a #10–32 screw suitable for terminating one 10 AWG wire with insulated ring or spade type terminal as shown.

Catalog Suffix "T"

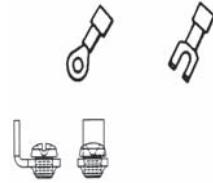

Available QCR and QCF Breaker Accessories

Description	Catalog Number
Steel mounting clip mounts QCR breaker if individual mounting is required. Quantity two required for single- and two-pole and four required for three-pole breakers.	QCRMTGFT
Removable padlock device for single-pole QCR or QCF breaker.	QCRFPL1P
Removable padlock device for multi-pole QCR or QCF breaker.	QCRFPLMP
Padlock bracket assembly for QCR or QCF single- or multi-pole breakers (OFF only).	QCRFLOFF
Padlock bracket for QCR, lock-off only.	QCRPLOFF

Technical Data and Specifications

- Single-, two- and three-pole
- 10 kAIC at 120/240 Vac, 10–60A
- 22 kAIC at 120/240 Vac, 15–20A
- 10 kAIC at 240 Vac, 10–30A
- 3 kAIC at 62.5 Vdc (single-pole)
- 3 kAIC at 130 Vdc (two poles in series)
- Normal operating environment:
 - 0–40°C
 - 5–95% humidity (noncondensing)

QUICKLAG Type QCGF Single-Pole Ground Fault Circuit Breaker



Contents

<i>Description</i>	<i>Page</i>
Quick Reference	V4-T1-2
QUICKLAG Plug-On Types HQP, QPHW, QHPX, QHPW QUICKLAG Plug-On Ground Fault and Equipment Protectors, Types QPGF, QPHGF, QPGFEP, QPHGFEP	V4-T1-5 V4-T1-8
Bolt-On Types BAB, QBHW, HBAX, HBAW	V4-T1-11
Bolt-On Arc Fault Circuit Interrupter Types QBAF, QBCAF	V4-T1-14
Bolt-On Ground Fault and Equipment Protectors, Types QBGF, QBHGF, QBGFEP, QBHGFEP	V4-T1-17
Cable-In/Cable-Out Types QC, QCD, QCHW, QHCX, QHCW	V4-T1-20
Cable-In/Cable-Out, 1/2-Inch Wide, Types QCR, QCF, QCRH, QCFH	V4-T1-24
Cable-In/Cable-Out Ground Fault and Equipment Protectors, Types QCGF, QCHGF, QCGFEP, QCHGFEP Product Selection	V4-T1-29 V4-T1-30 V4-T1-30
Wiring Diagram	V4-T1-30
Dimensions	V4-T1-30
Solenoid-Operated, Remote-Controlled Latching Types BABRP, BABRSP, BRRP and CLRP.	V4-T1-31
Solenoid Operator—Remote Controlled Latching for Type GHBS, GBHS and GHORSP Breakers.	V4-T1-34
International Rated Types HQP, BA, QC, GFMB, GFXBC Special Application Breakers, Types HQP, BA, QC	V4-T1-37 V4-T1-40

Cable-In/Cable-Out Ground Fault and Equipment Protectors, Types QCGF, QCHGF, QCGFEP, QCHGFEP

Product Description

QUICKLAG Ground Fault Circuit Breakers, Class A GFCI

- 5 mA trip sensitivity

QUICKLAG Ground Fault Equipment Protectors

- 30 mA trip sensitivity

Standards and Certifications

QUICKLAG Ground Fault Circuit Breakers, Class A GFCI

- Built and tested to UL 943

QUICKLAG Ground Fault Equipment Protectors

- Built and tested to UL 1053



Product Selection

**QUICKLAG Type QCGF
Single-Pole Ground
Fault Circuit Breaker**



Breaker Catalog Numbers

Continuous Ampere Rating at 40°C	Single-Pole	Two-Pole
	120 Vac Catalog Number	120/240 Vac Catalog Number
Ground Fault Circuit Breakers—5 mA Sensitivity		
QUICKLAG Type: QCGF 10,000A Interrupting Capacity Thermal-Magnetic Breakers		
15	QCGF1015	QCGF2015
20	QCGF1020	QCGF2020
25	QCGF1025	QCGF2025
30	QCGF1030	QCGF2030
40	QCGF1040	QCGF2040
50	—	QCGF2050
QUICKLAG Type: QCHGF 22,000A Interrupting Capacity Thermal-Magnetic Breakers		
15	QCHGF1015	QCHGF2015
20	QCHGF1020	QCHGF2020
25	QCHGF1025	QCHGF2025
30	QCHGF1030	QCHGF2030
Ground Fault Equipment Protectors—30 mA Sensitivity		
QUICKLAG Type: QCGFEP 10,000A Interrupting Capacity Thermal-Magnetic Breakers		
15	QCGFEP1015	QCGFEP2015
20	QCGFEP1020	QCGFEP2020
25	QCGFEP1025	QCGFEP2025
30	QCGFEP1030	QCGFEP2030
40	QCGFEP1040	QCGFEP2040
50	—	QCGFEP2050
QUICKLAG Type: QCHGFEP 22,000A Interrupting Capacity Thermal-Magnetic Breakers		
15	QCHGFEP1015	QCHGFEP2015
20	QCHGFEP1020	QCHGFEP2020
25	QCHGFEP1025	QCHGFEP2025
30	QCHGFEP1030	QCHGFEP2030
Special Application Ground Fault Circuit Protector—5 mA Sensitivity		
QUICKLAG Type: QCGF 10,000A Interrupting Capacity with Bell Alarm (W1) or Auxiliary Switch (W2)		
15	QCGF1015W1	QCGF2015W1
20	QCGF1020W1	QCGF2020W1
25	QCGF1025W1	QCGF2025W1
30	QCGF1030W1	QCGF2030W1
40	—	QCGF2040W1
50	—	QCGF2050W1
15	QCGF1015W2	—
20	QCGF1020W2	—
25	QCGF1025W2	—
30	QCGF1030W2	—
Special Application Ground Fault Equipment Protectors—30 mA Sensitivity		
QUICKLAG Type: QCGFEP 10,000A Interrupting Capacity with Bell Alarm (W1) or Auxiliary Switch (W2)		
15	QCGFEP1015W1	QCGFEP2015W1
20	QCGFEP1020W1	QCGFEP2020W1
25	QCGFEP1025W1	QCGFEP2025W1
30	QCGFEP1030W1	QCGFEP2030W1
40	—	QCGFEP2040W1
50	—	QCGFEP2050W1
15	QCGFEP1015W2	—
20	QCGFEP1020W2	—
25	QCGFEP1025W2	—
30	QCGFEP1030W2	—

1

Wiring Diagram

Bell Alarm and Auxiliary Contact Schematic



Single-throw double-pole contacts are UL and CSA listed for 5A at 250 Vac.

Bell Alarm (W1)—contacts change state when breaker trips.

Auxiliary Switch (W2)—contacts change state when breaker is opened (or tripped) or closed.

14-inch (355.6 mm) long 18 AWG pigtail wire leads provided.

Dimensions

Approximate Dimensions in Inches (mm)

Shipping Data

Number of Poles	Carton Quantity	Approximate Weight Lbs (kg)	Dimensions
1	20	11.00 (5.0)	12.50 x 6.50 x 5.00 (317.5 x 165.1 x 127.0)
2	5	5.00 (2.3)	15.50 x 6.00 x 4.50 (393.7 x 152.4 x 114.3)

**BABRP and BABRSP Breakers—
Single- and Two-Pole**



Solenoid-Operated, Remote-Controlled Latching Types BABRP, BABRSP, BRRP and CLRP

Product Description

The BABRP and BABRSP are bolt-on branch circuit breakers designed for use in panelboards. The BRRP is a plug-on branch circuit breaker designed for use in load-centers not manufactured with breakers with a 1-inch wide format and are listed on the “Compatibility list for Classified Applications”—Pub. 26271. In addition to providing conventional branch circuit protection, they include a unique solenoid-operated mechanism that provides for efficient breaker pulse-on and pulse-off operation when used with a suitable controller like Eaton’s Pow-R-Command™ lighting control system. These breakers can also be controlled by pushbutton or a PLC unit.

Application Description

Eaton’s BABRP, BABRSP, BRRP and CLRP breakers are remotely operated molded case circuit breakers ideally suited for lighting control applications or energy management applications.

Contents

<i>Description</i>	<i>Page</i>
Quick Reference	V4-T1-2
QUICKLAG Plug-On Types HQP, QPHW, QHPX, QHPW	V4-T1-5
QUICKLAG Plug-On Ground Fault and Equipment Protectors, Types QPGF, QPHGF, QPGFEP, QPHGFEP	V4-T1-8
Bolt-On Types BAB, QBHW, HBAX, HBAW	V4-T1-11
Bolt-On Arc Fault Circuit Interrupter Types QBAF, QBCAF	V4-T1-14
Bolt-On Ground Fault and Equipment Protectors, Types QBGF, QBHGF, QBGFEP, QBHGFEP	V4-T1-17
Cable-In/Cable-Out Types QC, QCD, QCHW, QHCX, QHCW	V4-T1-20
Cable-In/Cable-Out, 1/2-Inch Wide, Types QCR, QCF, QCRH, QCFH	V4-T1-24
Cable-In/Cable-Out Ground Fault and Equipment Protectors, Types QCGF, QCHGF, QCGFEP, QCHGFEP	V4-T1-28
Solenoid-Operated, Remote-Controlled Latching Types BABRP, BABRSP, BRRP and CLRP	V4-T1-32
Product Selection	V4-T1-33
Technical Data and Specifications	V4-T1-33
Wiring Diagrams	V4-T1-33
Solenoid Operator—Remote Controlled Latching for Type GHBS, GBHS and GHQRSP Breakers	V4-T1-34
International Rated Types HQP, BA, QC, GFMB, GFXBC	V4-T1-37
Special Application Breakers, Types HQP, BA, QC	V4-T1-40

Features, Benefits and Functions

- Bolt-on line-side terminal (BABRP, BABRSP—Type BA)
- Plug-on line-side terminal (BRRP—Type BR, CLRP—Type CL)
- Cable connected load-side terminal
- Four-position control terminal
- Bi-metal assembly for thermal overload protection
- Fast-acting short-circuit protection
- Arc-chute assembly for fast-acting arc extinction
- Three-position handle: OFF, TRIP (Center), ON
- Handle permits manual switching when control power is lost
- Mechanical trip indicator
- 15 and 20A breakers SWD (switching duty) rated
- HID ratings for HID (high intensity discharge) lighting
- All models HACR rated
- Status feedback of control circuit (BABRSP)
- Series rated (BABRP, BABRSP only)
 - BRRP series rated same as BR breakers
 - BABRP, BABRSP same as BA breakers

Product Selection

QUICKLAG Type QCGF Single-Pole Ground Fault Circuit Breaker



BABRP UL 489 and CSA 22.2 Interrupting Ratings

Number of Poles	Ampere Rating ^①	Interrupting Capacity (Symmetrical Amperes)			Catalog Number
		Vac (50/60 Hz) 120	120/240	277/480	
1	15	10,000	—	—	BABRP1015
	20	10,000	—	—	BABRP1020
	25	10,000	—	—	BABRP1025
	30	10,000	—	—	BABRP1030
2	15	—	10,000	—	BABRP2015
	20	—	10,000	—	BABRP2020
	25	—	10,000	—	BABRP2025
	30	—	10,000	—	BABRP2030

BRRP UL 489 and CSA 22.2 Interrupting Ratings

Number of Poles	Ampere Rating	Interrupting Capacity (Symmetrical Amperes)		Catalog Number
		Vac (50/60 Hz) 120	120/240	
1	15	10,000	—	BRRP115
	20	10,000	—	BRRP120
	25	10,000	—	BRRP125
	30	10,000	—	BRRP130
2	15	—	10,000	BRRP215
	20	—	10,000	BRRP220
	25	—	10,000	BRRP225
	30	—	10,000	BRRP230

BABRP and BABRSP Wire Harness

Description	Catalog Number
This 60-inch (1524.0 mm) wire pigtail provides a connection from a single BABRP's control plug to a customer's pushbutton, relay or PLC. Each box contains 12 pigtails. Wires are 22 AWG, 600V. Order in multiples of 12.	SLBKRPTL1

BABRSP UL 489 and CSA 22.2 Interrupting Ratings

Number of Poles	Ampere Rating ^①	Interrupting Capacity (Symmetrical Amperes)			Catalog Number
		Vac (50/60 Hz) 120	120/240	277/480	
1	15	10,000	—	—	BABRSP1015
	20	10,000	—	—	BABRSP1020
	25	10,000	—	—	BABRSP1025
	30	10,000	—	—	BABRSP1030
2	15	—	10,000	—	BABRSP2015
	20	—	10,000	—	BABRSP2020
	25	—	10,000	—	BABRSP2025
	30	—	10,000	—	BABRSP2030

CLRP UL 489 and CSA 22.2 Interrupting Ratings

Number of Poles	Ampere Rating	Interrupting Capacity (Symmetrical Amperes)		Catalog Number
		Vac (50/60 Hz) 120	120/240	
1	15	10,000	—	CLRP115
	20	10,000	—	CLRP120
	25	10,000	—	CLRP125
	30	10,000	—	CLRP130
2	15	—	10,000	CLRP215
	20	—	10,000	CLRP220
	25	—	10,000	CLRP225
	30	—	10,000	CLRP230

Note

^① Continuous current rating at 40°C.

Technical Data and Specifications

Solenoid Operating Data

- Power requirements: 24 Vac/dc (20.4V minimum–30V maximum)
 - Controlled signal: +AC/DC 8 ms minimum with zero cross, 300 ms maximum
- AC: 1.3 cycles minimum, 18 cycles or 300 ms maximum
- DC: 8 ms minimum, 300 ms maximum
- Maximum duty cycle of 6 OPEN/CLOSE cycles per minute
- Current draw: open 1A, close 3/4A
- Blue wire: power input (see power requirements)
- Black wire: remote opening
- Red wire: remote closing
- Yellow wire: feedback status from power input, maximum 0.50A draw (BABRSP only)

Operation

- Tripping system—the BABRP, BABRSP, BRRP and CLRP circuit breakers have a permanent trip unit that contains a factory preset thermal (overload) trip element in each pole
- Operating mechanism—the BABRP, BABRSP, BRRP and CLRP circuit breakers have an over-center toggle mechanism that provides quick-make, quick-break operation. The operating mechanism is trip free. An internal cross-bar provides a common tripping of all multi-pole circuit breakers

Operating/Application Data

- Ambient temperature: 0 to 40°C
- Nominal pulse magnitude: 24 Vac/dc
- Frequency: 50/60 Hz
- Maximum breaker cycling: 6 operations per minute
- Tolerance: +10% to –15% of nominal voltage
- Humidity: 0 to 95% noncondensing

Wiring Diagrams

Control Circuit for the BABRP and BABRSP

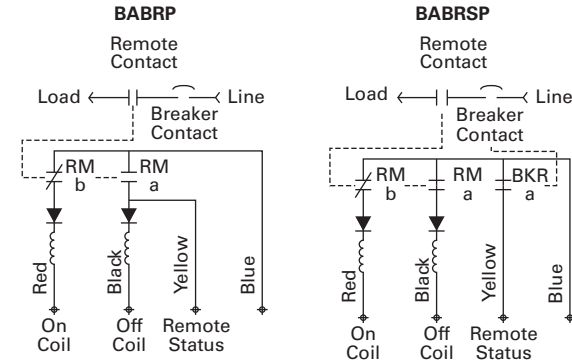

GHBS and GHQRSP



Contents

<i>Description</i>	<i>Page</i>
Quick Reference	V4-T1-2
QUICKLAG Plug-On Types HQP, QPHW, QHPX, QHPW QUICKLAG Plug-On Ground Fault and Equipment Protectors, Types QPGF, QPHGF, QPGFEP, QPHGFEP	V4-T1-5 V4-T1-8
Bolt-On Types BAB, QBHW, HBAX, HBAW	V4-T1-11
Bolt-On Arc Fault Circuit Interrupter Types QBAF, QBCAF	V4-T1-14
Bolt-On Ground Fault and Equipment Protectors, Types QBGF, QBHGF, QBGFEP, QBHGFEP	V4-T1-17
Cable-In/Cable-Out Types QC, QCD, QCHW, QHCX, QHCW	V4-T1-20
Cable-In/Cable-Out, 1/2-Inch Wide, Types QCR, QCF, QCRH, QCFH	V4-T1-24
Cable-In/Cable-Out Ground Fault and Equipment Protectors, Types QCGF, QCHGF, QCGFEP, QCHGFEP	V4-T1-28
Solenoid-Operated, Remote-Controlled Latching Types BABRP, BABRSP, BRRP and CLRP	V4-T1-31
Solenoid Operator—Remote Controlled Latching for Type GHBS, GBHS and GHQRSP Breakers Product Selection	V4-T1-35
Technical Data and Specifications	V4-T1-36
Wiring Diagrams	V4-T1-36
International Rated Types HQP, BA, QC, GFMB, GFXBC Special Application Breakers, Types HQP, BA, QC	V4-T1-37 V4-T1-40

Solenoid Operator—Remote-Controlled Latching for Type GHBS, GBHS and GHQRSP Breakers

Product Description

Eaton’s GHBS, GBHS and GHQRSP circuit breakers are bolt-on branch circuit breakers designed for use in 277/480 Vac panelboards. In addition to providing conventional branch circuit protection, they include a unique solenoid-operated mechanism that provides for efficient breaker pulse-on and pulse-off operation when used with a suitable controller like Eaton’s Pow-R-Command lighting control system.

Features, Benefits and Functions

- Bolt-on line-side terminal
- Cable-connected load-side terminal
- Status switch—remote status and breaker status available from internal auxiliary switches
- Bi-metal assembly for thermal overload protection
- Fast-acting short-circuit protection
- Arc-runner and arc-chute assembly for fast-acting arc extinction
- Three-position breaker handle: OFF, TRIP (Center), ON
- Visual indication of the remotely operated contact’s position (open, closed or trip)
- Remote override handle permits manual switching when control power is lost
- 15 and 20A breakers SWD (switching duty) rated.
- 15 and 20A breakers HID rated for HID (High intensity discharge) lighting
- All models HACR rated
- Series rated with various Eaton main circuit breakers

Product Selection

GHBS—Single-Pole



GHBS UL 489 Interrupting Ratings

Number of Poles	Ampere Rating ^①	Interrupting Capacity (Symmetrical Amperes)			Catalog Number
		Vac (50/60 Hz) 120	240	277/480	
1	15	65,000	—	14,000	GHBS1015D
	20	65,000	—	14,000	GHBS1020D
	30	65,000	—	14,000	GHBS1030D
2	15	—	65,000	14,000	GHBS2015D
	20	—	65,000	14,000	GHBS2020D
	30	—	65,000	14,000	GHBS2030D

GBHS CSA 22.2 Interrupting Ratings (Not UL Listed)

Number of Poles	Ampere Rating ^①	Interrupting Capacity (Symmetrical Amperes)		Catalog Number
		Vac (50/60 Hz) 347/600		
1	15	10,000		GBHS1015D
	20	10,000		GBHS1020D
2	15	10,000		GBHS2015D
	20	10,000		GBHS2020D

GHQRSP UL 489 and CSA 22.2 Interrupting Ratings

Number of Poles	Ampere Rating ^①	Interrupting Capacity (Symmetrical Amperes)				Catalog Number ^②
		Vac (50/60 Hz) 120	120/240	277	480Y/277	
1	15	65,000	65,000	14,000	14,000	GHQRSP1015
	20	65,000	65,000	14,000	14,000	GHQRSP1020
	30	65,000	65,000	14,000	14,000	GHQRSP1030
2	15	65,000	65,000	14,000	14,000	GHQRSP2015
	20	65,000	65,000	14,000	14,000	GHQRSP2020
	30	65,000	65,000	14,000	14,000	GHQRSP2030

Notes

- ① Continuous current rating at 40°C.
- ② All UL listed circuit breakers are HID (high intensity discharge) rated.

Technical Data and Specifications

Solenoid Operating Data

- Power requirements: 24 Vac/dc (20.4V minimum–30V maximum)
 - Controlled signal: +AC/DC 8 ms minimum with zero cross, 300 ms maximum
 - AC: 1.3 cycles minimum, 18 cycles or 300 ms maximum
 - DC: 8 ms minimum, 300 ms maximum
 - Maximum duty cycle of 6 OPEN/CLOSE cycles per minute
- Current draw: open 1A, close 3/4A
- Blue wire: power input (see power requirements)
- Black wire: remote opening

- Red wire: remote closing
- Yellow wire: feedback status from power input, maximum 0.50A draw

Operation

Mechanism manually operated by external handle allowing ON, OFF and RESET operation. Handle assumes a center TRIP position after performing protective response.

Operating/Application Data

- Ambient temperature: 0–40°C
- Frequency: 48–62 Hz
- Humidity: 0–95% noncondensing

Terminal Type

Circuit Breaker Type	Circuit Breaker Amperes	Screw Head Type	Terminal Type	Range
GHQRSP	15–20	Slotted	Clamp	#14–#4 AWG

Wiring Diagrams

Typical Single-Pole Circuit Breaker Schematic Diagram for GBHS and GBHS Breakers

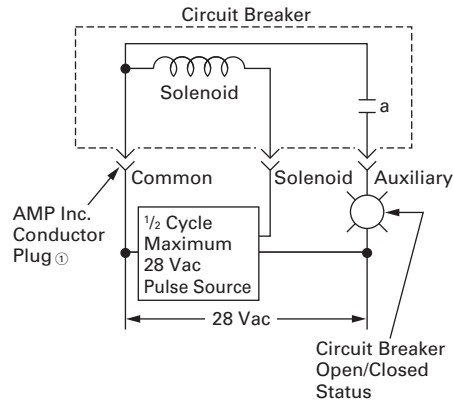

Typical Single-Pole Circuit Breaker Schematic Diagram for GHQRSP Breakers

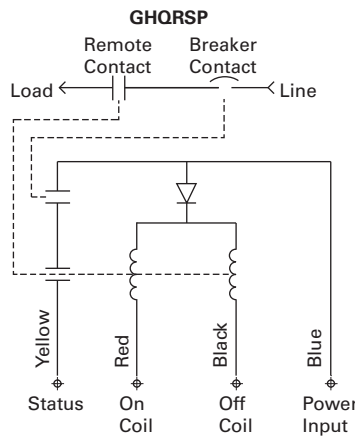

Dimensions

Approximate Dimensions in Inches (mm)

Dimensions per Pole

Circuit Breaker Type	Width	Height ^②	Length ^③
GHQRSP	1.00 (25.4)	4.63 (117.6)	2.81 (71.4)

Notes

- ① Purchase separate AMP Inc. conductor plug #640426-3.
- ② Excluding line terminal.
- ③ Excluding handle.

International Rated



Contents

<i>Description</i>	<i>Page</i>
Quick Reference	V4-T1-2
QUICKLAG Plug-On Types HQP, QPHW, QHPX, QHPW	V4-T1-5
QUICKLAG Plug-On Ground Fault and Equipment Protectors, Types QPGF, QPHGF, QPGFEP, QPHGFEP	V4-T1-8
Bolt-On Types BAB, QBHW, HBAX, HBAW	V4-T1-11
Bolt-On Arc Fault Circuit Interrupter Types QBAF, QBCAF	V4-T1-14
Bolt-On Ground Fault and Equipment Protectors, Types QBGF, QBHGF, QBGFEP, QBHGFEP	V4-T1-17
Cable-In/Cable-Out Types QC, QCD, QCHW, QHCX, QHCW	V4-T1-20
Cable-In/Cable-Out, 1/2-Inch Wide, Types QCR, QCF, QCRH, QCFH	V4-T1-24
Cable-In/Cable-Out Ground Fault and Equipment Protectors, Types QCGF, QCHGF, QCGFEP, QCHGFEP	V4-T1-28
Solenoid-Operated, Remote-Controlled Latching Types BABRP, BABRSP, BRRP and CLRP	V4-T1-31
Solenoid Operator—Remote Controlled Latching for Type GHBS, GBHS and GHQRSP Breakers.	V4-T1-34
International Rated Types HQP, BA, QC, GFMB, GFXBC Product Selection	V4-T1-38
Technical Data and Specifications	V4-T1-39
Dimensions	V4-T1-39
Special Application Breakers, Types HQP, BA, QC	V4-T1-40

International Rated Types HQP, BA, QC, GFMB, GFXBC

Product Description

QUICKLAG International Circuit Breakers

- Bolt-on Type BA

QUICKLAG International Ground Fault Circuit Breakers

- Plug-on Type GFMB
- Cable-in/cable-out Type GFXBC

Standards and Certifications

QUICKLAG International Circuit Breakers

- Built and test certified to BS3871, Pt. 1
- 50/60 Hz, 40°C

QUICKLAG International Ground Fault Circuit Breakers

- Built and test certified to BS3871, Pt. 1; BS3871, Section 31-C; BS4293
- 50/60 Hz, 40°C; 30 mA sensitivity

Product Selection

BAB



Breaker Catalog Numbers

Continuous Ampere Rating at 40°C	Single-Pole	Two-Pole	Three-Pole
	240/415 Vac Catalog Number	240/415 Vac Catalog Number	240/415 Vac Catalog Number
3000A Interrupting Capacity (M3) Bolt-On Thermal-Magnetic Circuit Breakers			
10	BAB1010E	BAB2010E	BAB3010E
15	BAB1015E	BAB2015E	BAB3015E
16	—	—	—
20	BAB1020E	BAB2020E	BAB3020E
25	BAB1025E	BAB2025E	BAB3025E
30	BAB1030E	BAB2030E	BAB3030E
32	—	—	—
40	BAB1040E	BAB2040E	BAB3040E
50	BAB1050E	BAB2050E	BAB3050E
60	BAB1060E	BAB2060E	BAB3060E
70	BAB1070E	BAB2070E	BAB3070E
90	—	BAB2090E	BAB3090E
100	—	BAB2100E	BAB3100E

6000A Interrupting Capacity (M6) Bolt-On Thermal-Magnetic Circuit Breakers

15	BAB1015HE	BAB2015HE	BAB3015HE
20	BAB1020HE	BAB2020HE	BAB3020HE
25	BAB1025HE	BAB2025HE	BAB3025HE
30	BAB1030HE	BAB2030HE	BAB3030HE
40	BAB1040HE	BAB2040HE	BAB3040HE
50	BAB1050HE	BAB2050HE	BAB3050HE
60	BAB1060HE	BAB2060HE	BAB3060HE
70	BAB1070HE	BAB2070HE	BAB3070HE
90	—	BAB2090HE	BAB3090HE
100	—	BAB2100HE	BAB3100HE

Breaker Catalog Numbers—Ground Fault Single-Pole 30 mA Sensitivity

Continuous Ampere Rating at 40°C	240/415 Vac Catalog Number
3000A Interrupting Capacity (M3) Plug-On Thermal-Magnetic Circuit Breakers	
10	GFMB110B2
15	GFMB115B2
16	GFMB116B2
20	GFMB120B2
25	GFMB125B2
30	GFMB130B2
32	GFMB132B2
40	GFMB140B2

Note

For other 240/415V applications, please contact the Customer Support Center at 1-800-356-1243.

Technical Data and Specifications

Interrupting Ratings

Ratings	Suffix E	Suffix HE
International Circuit Breakers		
NEMA® 120/240 Vac	10,000 AIC	10,000 AIC
BS3871 220/380, 240/415 Vac	3000 AIC	6000 AIC
International Ground Fault Circuit Breakers		
BS3871 220/380, 240/415 Vac	3000 AIC	

Dimensions

Approximate Dimensions in Inches (mm)

Shipping Data

Miniature Circuit Breaker	Number of Poles	Standard Carton Quantity	Approximate Carton Weight Lbs (kg)	Approximate Standard Carton
QUICKLAG Type B	1	24	9.00 (4.1)	12.50 x 7.50 x 5.00 (317.5 x 190.5 x 127.0)
	2	12	9.00 (4.1)	12.50 x 7.50 x 5.00 (317.5 x 190.5 x 127.0)
	3	8	9.00 (4.1)	12.50 x 7.50 x 5.00 (317.5 x 190.5 x 127.0)
QUICKLAG Ground Fault				
Type P—All	1	20	11.00 (5.0)	12.50 x 6.50 x 5.00 (317.5 x 165.1 x 127.0)
Types B and C—All	1	20	11.00 (5.0)	12.50 x 7.00 x 5.50 (317.5 x 177.8 x 139.7)
Types P and B—All	2	5	5.00 (2.3)	12.50 x 6.00 x 4.50 (317.5 x 152.4 x 114.3)

QUICKLAG Type P Switching Neutral



Contents

<i>Description</i>	<i>Page</i>
Quick Reference	V4-T1-2
QUICKLAG Plug-On Types HQP, QPHW, QHPX, QHPW	V4-T1-5
QUICKLAG Plug-On Ground Fault and Equipment Protectors, Types QPGF, QPHGF, QPGFEP, QPHGFEP	V4-T1-8
Bolt-On Types BAB, QBHW, HBAX, HBAW	V4-T1-11
Bolt-On Arc Fault Circuit Interrupter Types QBAF, QBCAF	V4-T1-14
Bolt-On Ground Fault and Equipment Protectors, Types QBGF, QBHGF, QBGFEP, QBHGFEP	V4-T1-17
Cable-In/Cable-Out Types QC, QCD, QCHW, QHCX, QHCW	V4-T1-20
Cable-In/Cable-Out, 1/2-Inch Wide, Types QCR, QCF, QCRH, QCFH	V4-T1-24
Cable-In/Cable-Out Ground Fault and Equipment Protectors, Types QCGF, QCHGF, QCGFEP, QCHGFEP	V4-T1-28
Solenoid-Operated, Remote-Controlled Latching Types BABRP, BABRSP, BRRP and CLRP	V4-T1-31
Solenoid Operator—Remote Controlled Latching for Type GHBS, GBHS and GHQRSP Breakers	V4-T1-34
International Rated Types HQP, BA, QC, GFMB, GFXBC	V4-T1-37
Special Application Breakers, Types HQP, BA, QC	
Product Selection	V4-T1-41
Accessories	V4-T1-43
Factory Modifications and Installed Terminals	V4-T1-46
Technical Data and Specifications	V4-T1-47
Dimensions	V4-T1-48

Special Application Breakers, Types HQP, BA, QC

Product Description

Breakers

- Plug-on Type HQP: 10–30A, single- and two-pole, 10 kAIC
- Bolt-on Type BA: 10–30A, single- and two-pole, 10 kAIC
- Cable-in Type QC: 10–30A, single- and two-pole, 10 kAIC

Switching neutral QUICKLAG breakers available in single- and two-pole configurations, plus neutral pole for applications in accordance with NEC® 514.5, 240.22 and 380.2. A single-pole device takes two pole spaces, and a two-pole device takes three pole spaces.

QUICKLAG HID (High Intensity Discharge) Breakers

- Plug-on Type HQP: 15–60A, single- and two-pole, 10 kAIC
- Bolt-on Type BA: 15–60A, single- and two-pole, 10 kAIC
- Cable-in Type QC: 15–60A, single- and two-pole, 10 kAIC

Breakers designed specifically for use with high intensity discharge (HID) lighting applications. (UL listed as standard lighting breakers.)

Molded Case Switches—Non-automatic QUICKLAG Molded Case Switch

- Plug-on Type HQP: 50, 60, 100A, single-, two- and three-pole
- Bolt-on Type BA: 50, 60, 100A, single-, two- and three-pole
- Cable-in Type QC: 50, 60, 100A, single-, two- and three-pole

Standards and Certifications

- All products UL and CSA listed



Product Selection

QUICKLAG Type P
Switching Neutral



Breaker Catalog Numbers

Continuous Ampere Rating at 40°C	Single-Pole 120/240 Vac Catalog Number	Two-Pole 120/240 Vac Catalog Number	Two-Pole 240 Vac Catalog Number	Three-Pole 240 Vac Catalog Number
QUICKLAG Type: HQP Switching Neutral Thermal-Magnetic Breakers				
10	HQP2010B	HQP3010B	—	—
15	HQP2015B	HQP3015B	—	—
20	HQP2020B	HQP3020B	—	—
25	HQP2025B	HQP3025B	—	—
30	HQP2030B	HQP3030B	—	—
QUICKLAG Type: BA Switching Neutral Thermal-Magnetic Breakers				
10	BAB2010C	BAB3010C	—	—
15	BAB2015C	BAB3015C	—	—
20	BAB2020C	BAB3020C	—	—
25	BAB2025C	BAB3025C	—	—
30	BAB2030C	BAB3030C	—	—
QUICKLAG Type: QC Switching Neutral Thermal-Magnetic Breakers				
10	QC2010B	QC3010B	—	—
15	QC2015B	QC3015B	—	—
20	QC2020B	QC3020B	—	—
25	QC2025B	QC3025B	—	—
30	QC2030B	QC3030B	—	—
QUICKLAG Type: HQP HID (High Intensity Discharge) Thermal-Magnetic Breakers				
15	HQP1015D	HQP2015D	—	—
20	HQP1020D	HQP2020D	—	—
25	HQP1025D	HQP2025D	—	—
30	HQP1030D	HQP2030D	—	—
35	HQP1035D	HQP2035D	—	—
40	HQP1040D	HQP2040D	—	—
50	HQP1050D	HQP2050D	—	—
60	HQP1060D	HQP2060D	—	—
QUICKLAG Type: BA HID (High Intensity Discharge) Thermal-Magnetic Breakers				
15	BAB1015D	BAB2015D	—	—
20	BAB1020D	BAB2020D	—	—
25	BAB1025D	BAB2025D	—	—
30	BAB1030D	BAB2030D	—	—
35	BAB1035D	BAB2035D	—	—
40	BAB1040D	BAB2040D	—	—
50	BAB1050D	BAB2050D	—	—
60	BAB1060D	BAB2060D	—	—
QUICKLAG Type: QC HID (High Intensity Discharge) Thermal-Magnetic Breakers				
15	QC1015D	QC2015D	—	—
20	QC1020D	QC2020D	—	—
25	QC1025D	QC2025D	—	—
30	QC1030D	QC2030D	—	—
35	QC1035D	QC2035D	—	—
40	QC1040D	QC2040D	—	—
50	QC1050D	QC2050D	—	—
60	QC1060D	QC2060D	—	—

Breaker Catalog Numbers, continued

Continuous Ampere Rating at 40°C	Single-Pole	Two-Pole	Two-Pole	Three-Pole
	120/240 Vac Catalog Number	120/240 Vac Catalog Number	240 Vac Catalog Number	240 Vac Catalog Number
QUICKLAG Type: HQP Non-Automatic Switches				
50	HQP1050N	—	HQP2050N	HQP3050N
60	HQP1060N	—	HQP2060N	HQP3060N
100	HQP1100N	—	HQP2100N	HQP3100N
QUICKLAG Type: BA Non-Automatic Switches				
50	BAB1050N	—	BAB2050N	BAB3050N
60	BAB1060N	—	BAB2060N	BAB3060N
100	BAB1100N	—	BAB2100N	BAB3100N
QUICKLAG Type: QC Non-Automatic Switches				
50	QC1050N	—	QC2050N	QC3050N
60	QC1060N	—	QC2060N	QC3060N
100	QC1100N	—	QC2100N	QC3100N
QUICKLAG Type: QCD Non-Automatic Switches				
60	—	—	QCD2060NA	—
100	—	—	—	—

Accessories ①

Handle Locks: Non-Padlockable ②

	Description	Order in Multiples of	Catalog Number
QL1NPL	QUICKLAG Type P, B, C—single-pole	10	QL1NPL



QL23NPL	QUICKLAG Type P, B, C—two- and three-pole	10	QL23NPL
---------	---	----	---------



Handle Locks: Padlockable ②

	Description	Order in Multiples of	Catalog Number
QL1PL	QUICKLAG Type P, B, C—single-pole	10	QL1PL



QL123PL	QUICKLAG Type P, B and ground fault—single-, two- and three-pole	10	QL123PL
---------	--	----	---------



QC123PL	QUICKLAG Type C—single-, two- and three-pole	10	QC123PL
---------	--	----	---------



	QUICKLAG Type P, B—single-, two- and three-pole (off only)	10	QL123PLOFF
	QUICKLAG Type C—single-, two- and three-pole (off only)	10	QC123PLOFF

Notes

- ① See **Page V4-T1-27** for QCR and QCF accessories.
- ② Can lock in ON or OFF position.



Mounting Hardware

	Description	Order in Multiples of	Catalog Number
	QUICKLAG Type C face mounting clip	24	QCFLIP
	QUICKLAG Type C face mounting plate—single-pole	10	QC1FP
	QUICKLAG Type C face mounting plate—two-pole	10	QC2FP
	QUICKLAG Type C face mounting plate—three-pole	10	QC3FP
	QUICKLAG Type C face mounting plate and lock-off (off only)—two-pole ①	10	QC2FPLOFF
	QUICKLAG Type C face mounting plate and lock-off (off only)—three-pole	10	QC3FPLOFF
	QUICKLAG Type C base mounting clamp	10	QCBCLIP
	QUICKLAG Type mounting plate—six poles total	10	QC6BP

Note

① Suitable for ground fault breakers.

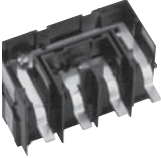
Mounting Hardware, continued

	Description	Order in Multiples of	Catalog Number
	QUICKLAG Type C base mounting plate—six poles total—heavy-duty screw-secured	10	QC6BPS
	QUICKLAG Type C (QCD) 2-way jumper unit with cover	10	QCDJ2
QCDJ4	QUICKLAG Type C (QCD) 4-way jumper unit with cover	10	QCDJ4
			
	QUICKLAG Type C (QCD) 6-way jumper unit with cover	10	QCDJ6
	QUICKLAG Type C (QCD) 2-way jumper unit, no cover	10	QCDJ2T
	QUICKLAG Type C (QCD) 4-way jumper unit, no cover	10	QCDJ4T
	QUICKLAG Type C (QCD) 6-way jumper unit, no cover	10	QCDJ6T
	QUICKLAG Type QCD Finger protection attachment	10	QCDFP
	QUICKLAG Type QCD 4-prong Quick Connect	10	QCDQUICK
QCDINADAPT	QUICKLAG Type C DIN rail adapter	6	QCDINADAPT
			
QCDRING	QUICKLAG Type QCD ring lug attachment	10	QCDRING
			

Dummy Breakers

Description	Order in Multiples of	Catalog Number
QUICKLAG Type P	1	HQP1000
QUICKLAG Type B	1	BAB1000
QUICKLAG Type C	1	QC1000
QUICKLAG Type C clear choice breaker	4	QC30SAMPLE

QCRSPACER

Miscellaneous

Description	Order in Multiples of	Catalog Number
QUICKLAG Type C Spacer	1	QCRSPACER

QL1HT

Handle Tie

Description	Order in Multiples of	Catalog Number
QUICKLAG handle tie—single-pole	100	QL1HT



Factory Modifications and Installed Terminals

Factory Modifications ^①

Type of Modification	Breaker Type	Catalog Suffix
Shunt trip (requires one extra pole space on right side) 120, 208, 240 Vac Draws 2.6A at 120V, draws 11A at 24 Vdc	QUICKLAG Types P, B and C	S
Shunt trip (requires one extra pole space on right side) 24, 48 Vac/dc Draws 2.6A at 120V, draws 11A at 24 Vdc	QUICKLAG Types P, B and C	S1
Special calibration (50°C) (no UL)	QUICKLAG Types P, B and C	V
Shock testing	QUICKLAG Types P, B and C	L
Freeze testing	QUICKLAG Types P, B and C	Y
Moisture-fungus treatment	QUICKLAG Types P, B, C and ground fault	F
Marine duty	QUICKLAG Types P, B, C	H08
Naval duty	QUICKLAG Types P, B, C	H09
400 Hz calibration	QUICKLAG Types P, B, C	G
Specific DC ratings (breaker marked with a max. Vdc rating)	QUICKLAG Types P, B, C	Q thru Q9 ^②

Spare Terminal Hardware Screws (Lugs not Included)

Terminal Type	Description	Order in Multiples of	Catalog Number
1	QUICKLAG terminal screw	10	QLD TSA
2	QUICKLAG terminal screw	10	QLD TSB
3	QUICKLAG terminal screw	10	QLD TSC
5	QUICKLAG binding head terminal screw and clamp	10	QLB HTSE
6 and 7	QUICKLAG terminal screw	10	QLL NT SFG

Notes

^① Contact Eaton for factory modifications available for QCR and QCF breakers.

^② Q = 32 Vdc; Q1 = 32–40 Vdc; Q2 = 37.5 Vdc; Q3 = 45 Vdc; Q4 = 48 Vdc; Q5 = 50 Vdc; Q6 = 62.5 Vdc; Q7 = 75 Vdc (2P); Q8 = 80 Vdc (2P); Q9 = 125 Vdc (QCR 2P); Q10 = 62.5 Vdc (QCR 1P).

Technical Data and Specifications

Factory-Installed Breaker Terminals

Breaker Type	Continuous Ampere Rating	Standard Line Terminal			Standard Load Terminal			Optional Terminals	
		Terminal Type	Wire Type	Wire Range (AWG)	Terminal Type	Wire Type	Wire Range (AWG)	Line	Load
QUICKLAG Type P HQP, QPHW, QHPX, QHPW	10–30	Plug-on female clips that mate with the bus stabs			1	Cu/Al	14–4	N/A	3
	35–50				2	Cu/Al	14–4	N/A	3
	55–125				3	Cu/Al	8–1/0	N/A	—
QUICKLAG ground fault QPGF, QPGFEP, QPHGF, QPHGFEP	10–40	Plug-on female clips that mate with the bus stabs			1 (single-pole)	Cu/Al	14–4	N/A	3
	10–40				1	Cu/Al	—	N/A	3
	10–30				1	Cu	14–8	N/A	—
QUICKLAG Type B BAB, QBHW, HBAX, HBAW	10–40	Extended tangs that bolt directly to the bus			1 (single- and two-pole)	Cu/Al	14–4	N/A	3
	35–50				2 (three-pole)	Cu/Al	14–4	N/A	3
	55–125				3	Cu/Al	8–1/0	N/A	—
QUICKLAG ground fault QBGF, QBGFEP, QBHGF, QBHGFEP	10–40	Extended tangs that bolt directly to the bus			1 (single-pole)	Cu/Al	14–4	N/A	N/A
	10–40				1	Cu/Al	14–8	N/A	N/A
	10–30				1	Cu	14–8	N/A	N/A
QUICKLAG Type C QC, QCHW, QHCX, QHCW	10–20	5	Cu/Al	TBD	5	Cu/Al	14–10	6, 7	6, 7, 8
	25–60	6	Cu/Al	TBD	2	Cu/Al	14–4	5, 7	5, 6, 7, 8
	70–100	7	Cu/Al	TBD	3	Cu/Al	8–1/0	5	5, 7, 8
QUICKLAG QCR, QCF	10–55	1	Cu/Al	TBD	1	Cu/Al	14–4	N/A	N/A
	60	1	Cu	TBD	1	Cu	14–4	N/A	N/A
QUICKLAG ground fault QCGF, QCGFEP, QCHGF, QCHGFEP	10–20	6	Cu/Al	TBD	14–8	Cu/Al	14–4	6, 7	5
	25–50	6	Cu/Al	TBD	1	Cu/Al	14–4	5, 7	5
	10–30	6	—	—	—	—	—	—	—
QUICKLAG QCD	10–60	9	Cu/Al	14–4	9	Cu/Al	14–4	See Accessories	
	70–100	10	Cu	4–1/0	10	Cu	4–1/0	See Accessories	

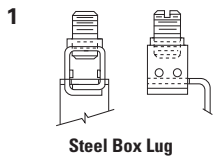

Steel Box Lug

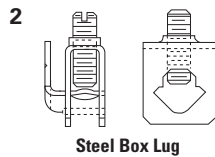

Steel Box Lug

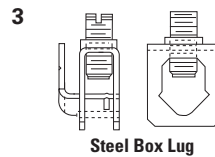

Steel Box Lug

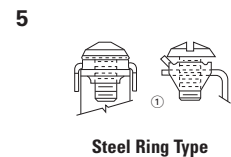

Steel Ring Type

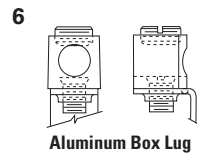

Aluminum Box Lug

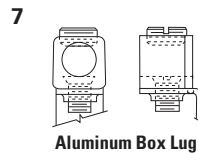

Aluminum Box Lug



4-Prong Quick Connect

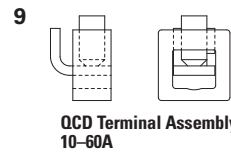

QCD Terminal Assembly 10–60A

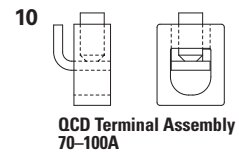

QCD Terminal Assembly 70–100A

Note

⊙ Clamp on line side only.

1

Dimensions

Approximate Dimensions in Inches (mm)

Shipping Data

Miniature Circuit Breaker	Number of Poles	Standard Carton Quantity	Approximate Carton Weight Lbs (kg)	Approximate Standard Carton
QUICKLAG Types B, P, C—all	1	24	9.00 (4.1)	12.50 x 7.50 x 5.00 (317.5 x 190.5 x 127.0)
QUICKLAG Types B, P, C—all	2	12	9.00 (4.1)	12.50 x 7.50 x 5.00 (317.5 x 190.5 x 127.0)
QUICKLAG Types B, P, C—all	3	8	9.00 (4.1)	12.50 x 7.50 x 5.00 (317.5 x 190.5 x 127.0)
QUICKLAG ground fault Type P—all	1	20	11.00 (5.0)	12.50 x 6.50 x 5.00 (317.5 x 165.1 x 127.0)
Types B and C—all	1	20	11.00 (5.0)	12.50 x 7.00 x 5.50 (317.5 x 177.8 x 139.7)
Types P and B—all	2	5	5.00 (2.3)	12.50 x 6.00 x 4.50 (317.5 x 152.4 x 114.3)

FAZ-NA Circuit Breakers



Optimum and Efficient Protection for Every Application

Contents

Description

	<i>Page</i>
FAZ-NA Circuit Breakers	
Catalog Number Selection	V4-T1-50
Product Selection	V4-T1-51
Accessories	V4-T1-55
Technical Data and Specifications	V4-T1-57
Dimensions	V4-T1-66

FAZ-NA Circuit Breakers

Product Overview

Optimum product quality, tested reliability and safety stand for best protection of personnel, installations and plant. Eaton's FAZ-NA DIN rail mountable circuit breaker is designed for use in branch service applications.

Powerful Offering for Machine and System Builders

The FAZ-NA is available with B, C and D characteristics in accordance with UL[®] 489, CSA[®] C22.2 No.5; UL 1077, CSA C22.2 No.235 and IEC 60947-2. These devices are CE marked.

Application Description

Feeder and branch circuit protection for:

- Convenience receptacle circuits (internal/external)
- Motor control circuits
- Load circuits leaving the equipment (external)
- HACR internal/external equipment (heating, air conditioning, refrigeration)
- PLC I/O points
- Computers
- Power supplies
- Control instrumentation
- Relays
- UPS
- Power conditioners

Features

- Complete range of UL 489 listed DIN rail mounted miniature circuit breakers up to 40A current rating
- Standard ratings of 10 kAIC up to 277/480 Vac
- Select amperages available at 14 kAIC up to 277/480 Vac and 10 kAIC up to 125 Vdc per pole
- Current limiting design provides fast short-circuit interruption that reduces the let-through energy, which can damage the circuit
- Suitable for branch circuit device protection
- Thermal-magnetic overcurrent protection
 - Three levels of short-circuit protection, categorized by B, C and D curves
- Trip-free design—breaker can not be defeated by holding the handle in the ON position
- Captive screws cannot be lost
- SWD (switching duty)—suitable for switching fluorescent lighting loads ($I_n \leq 20A$)
- Fulfill UL 489, CSA C22.2 No.5 and also IEC 60947-2 Standard
- For use in applications for which UL 1077 or CSA C22.2 No.235 are also allowed
- Field-installable shunt trip and auxiliary switch subsequent mounting
- Separate version for ring-tongue connection (Type FAZ-RT), terminal screws can be removed (on both sides)
- Module width of only 17.7 mm (per pole)
- Contact Position Indicator (red/green)
- Easy installation on DIN rail
- Possibility for sealing the toggle in ON or OFF position

Device Printing on Front and Side Installation options

These branch circuit breakers are available in two terminal configurations: standard box terminals that accept multiple conductors and ring-tongue terminals, ideally suited to demanding requirements of the semi-conductor industry. All breakers mount on standard 35 mm DIN rail. Bus connectors and feeder terminal facilitate mounting and wiring of multiple miniature circuit breaker arrays in control panel assemblies. These circuit breakers can also be reverse feed.

1.2

Miniature Circuit Breakers and Supplementary Protectors

UL 489 DIN Rail Miniature Circuit Breakers

1

Standards and Certifications

FAZ-NA complies with the latest national and international standards.

- RoHS compliant
- VDE compliant
- ABS compliant

UL 489

- Standard for molded case circuit breakers (MCCB) for feeder and branch circuit protection
- Products meet the requirements of the National Electrical Code® (NEC®)



CSA C22.2 No.5

- Standard for molded case circuit breakers (MCCB) for feeder and branch circuit protection (corresponds closely to UL 489 Standard)
- Products meet the requirements of the Canadian Electrical Code (CEC)

Catalog Number Selection

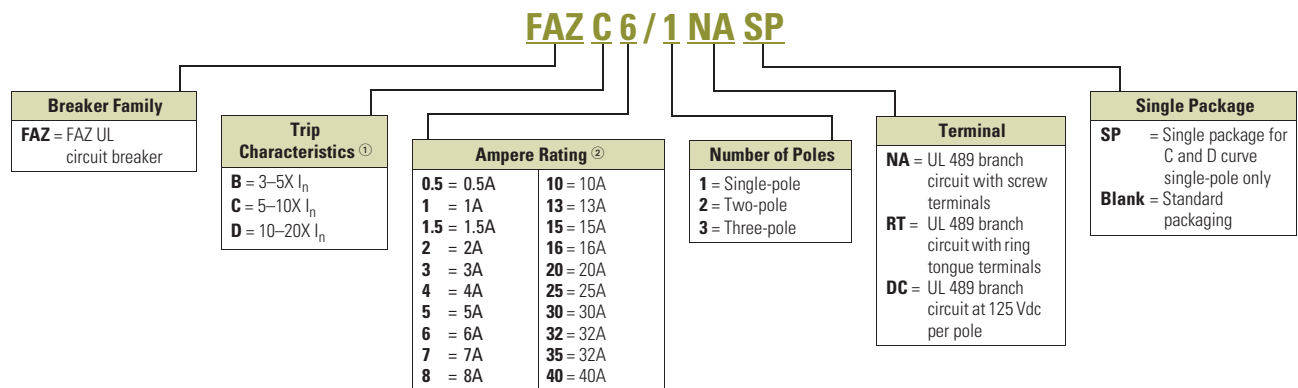

Notes

- ① I_n = Rated current for instantaneous trip characteristics.
 ② B curve starts at 1 ampere.

Product Selection

FAZ-NA B Curve

- UL approved (UL 489) and CSA Certified (CSA C22.2 No.5-02) as branch circuit breakers
- Interrupting capacity: 10 kA UL/CSA; 15 kA IEC 60947-2
- Current limiting device
- UL file number E235139

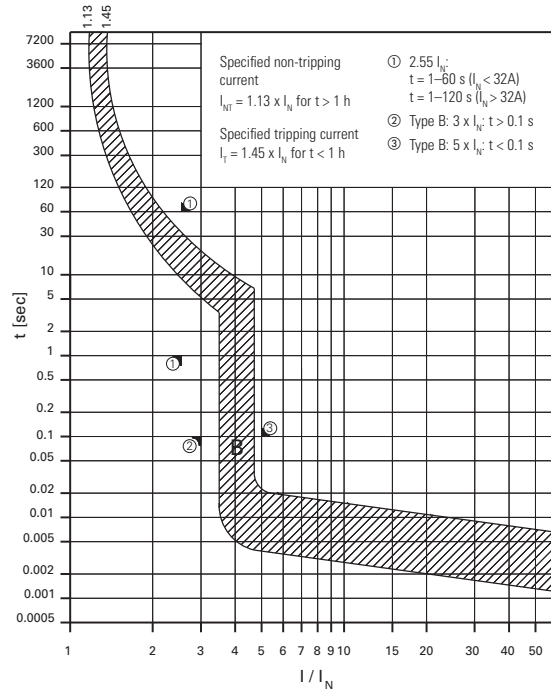

Single-Pole



Two-Pole



Three-Pole



FAZ-NA UL 489 Circuit Breakers— 10 kAIC, 14 kAIC B Curve (15–25A)

Amperes	Single-Pole ^① Catalog Number	Two-Pole Catalog Number	Three-Pole Catalog Number
B Curve (3–5X I_n Current Rating)			
1	FAZ-B1/1-NA	FAZ-B1/2-NA	FAZ-B1/3-NA
1.5	FAZ-B1.5/1-NA	FAZ-B1.5/2-NA	FAZ-B1.5/3-NA
2	FAZ-B2/1-NA	FAZ-B2/2-NA	FAZ-B2/3-NA
3	FAZ-B3/1-NA	FAZ-B3/2-NA	FAZ-B3/3-NA
4	FAZ-B4/1-NA	FAZ-B4/2-NA	FAZ-B4/3-NA
5	FAZ-B5/1-NA	FAZ-B5/2-NA	FAZ-B5/3-NA
6	FAZ-B6/1-NA	FAZ-B6/2-NA	FAZ-B6/3-NA
7	FAZ-B7/1-NA	FAZ-B7/2-NA	FAZ-B7/3-NA
8	FAZ-B8/1-NA	FAZ-B8/2-NA	FAZ-B8/3-NA
10	FAZ-B10/1-NA	FAZ-B10/2-NA	FAZ-B10/3-NA
13	FAZ-B13/1-NA	FAZ-B13/2-NA	FAZ-B13/3-NA
15	FAZ-B15/1-NA	FAZ-B15/2-NA	FAZ-B15/3-NA
16	FAZ-B16/1-NA	FAZ-B16/2-NA	FAZ-B16/3-NA
20	FAZ-B20/1-NA	FAZ-B20/2-NA	FAZ-B20/3-NA
25	FAZ-B25/1-NA	FAZ-B25/2-NA	FAZ-B25/3-NA
30	FAZ-B30/1-NA	FAZ-B30/2-NA	FAZ-B30/3-NA
32	FAZ-B32/1-NA	FAZ-B32/2-NA	FAZ-B32/3-NA
35 ^②	FAZ-B35/1-NA	FAZ-B35/2-NA	FAZ-B35/3-NA
40 ^②	FAZ-B40/1-NA	FAZ-B40/2-NA	FAZ-B40/3-NA

Single-Pole



Two-Pole



Three-Pole



FAZ-RT UL 489 Circuit Breakers with Ring-Tongue Terminals— 10 kAIC, 14 kAIC B Curve (15–25A)

Amperes	Single-Pole ^① Catalog Number	Two-Pole Catalog Number	Three-Pole Catalog Number
B Curve with Ring-Tongue Terminals (3–5X I_n Current Rating)			
1	FAZ-B1/1-RT	FAZ-B1/2-RT	FAZ-B1/3-RT
1.5	FAZ-B1.5/1-RT	FAZ-B1.5/2-RT	FAZ-B1.5/3-RT
2	FAZ-B2/1-RT	FAZ-B2/2-RT	FAZ-B2/3-RT
3	FAZ-B3/1-RT	FAZ-B3/2-RT	FAZ-B3/3-RT
4	FAZ-B4/1-RT	FAZ-B4/2-RT	FAZ-B4/3-RT
5	FAZ-B5/1-RT	FAZ-B5/2-RT	FAZ-B5/3-RT
6	FAZ-B6/1-RT	FAZ-B6/2-RT	FAZ-B6/3-RT
7	FAZ-B7/1-RT	FAZ-B7/2-RT	FAZ-B7/3-RT
8	FAZ-B8/1-RT	FAZ-B8/2-RT	FAZ-B8/3-RT
10	FAZ-B10/1-RT	FAZ-B10/2-RT	FAZ-B10/3-RT
13	FAZ-B13/1-RT	FAZ-B13/2-RT	FAZ-B13/3-RT
15	FAZ-B15/1-RT	FAZ-B15/2-RT	FAZ-B15/3-RT
16	FAZ-B16/1-RT	FAZ-B16/2-RT	FAZ-B16/3-RT
20	FAZ-B20/1-RT	FAZ-B20/2-RT	FAZ-B20/3-RT
25	FAZ-B25/1-RT	FAZ-B25/2-RT	FAZ-B25/3-RT
30	FAZ-B30/1-RT	FAZ-B30/2-RT	FAZ-B30/3-RT
32	FAZ-B32/1-RT	FAZ-B32/2-RT	FAZ-B32/3-RT
35 ^②	FAZ-B35/1-RT	FAZ-B35/2-RT	FAZ-B35/3-RT
40 ^②	FAZ-B40/1-RT	FAZ-B40/2-RT	FAZ-B40/3-RT

Notes

- ^① Two-piece order. Quantities of two per box.
- ^② 240 Vac rated only.

1.2

Miniature Circuit Breakers and Supplementary Protectors

UL 489 DIN Rail Miniature Circuit Breakers

1

FAZ-NA C Curve

- UL approved (UL 489) and CSA Certified (CSA C22.2 No.5-02) as branch circuit breakers
- Interrupting capacity: 10 kA UL/CSA; 15 kA IEC 60947-2
- Current limiting device
- UL file number E235139

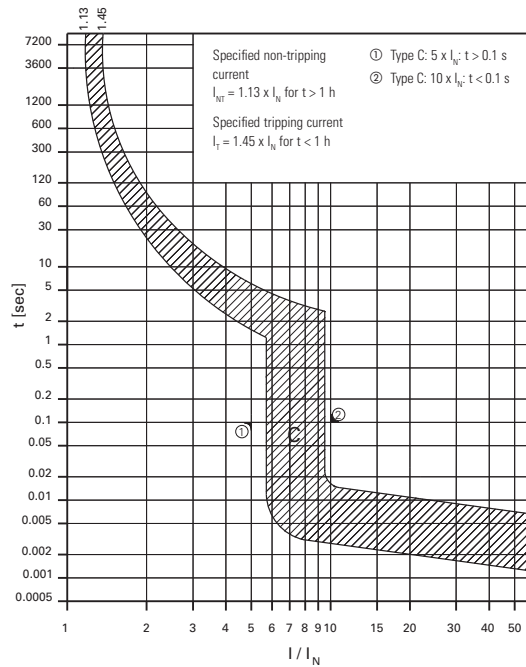

Single-Pole



Two-Pole



Three-Pole



FAZ-NA UL 489 Circuit Breakers— 10 kAIC, 14 kAIC C Curve (15–25A)

Amperes	Single-Pole ① Catalog Number	Two-Pole Catalog Number	Three-Pole Catalog Number
C Curve (5–10X I_N Current Rating)			
0.5	FAZ-C0.5/1-NA-SP	FAZ-C0.5/2-NA	FAZ-C0.5/3-NA
1	FAZ-C1/1-NA-SP	FAZ-C1/2-NA	FAZ-C1/3-NA
1.5	FAZ-C1.5/1-NA-SP	FAZ-C1.5/2-NA	FAZ-C1.5/3-NA
2	FAZ-C2/1-NA-SP	FAZ-C2/2-NA	FAZ-C2/3-NA
3	FAZ-C3/1-NA-SP	FAZ-C3/2-NA	FAZ-C3/3-NA
4	FAZ-C4/1-NA-SP	FAZ-C4/2-NA	FAZ-C4/3-NA
5	FAZ-C5/1-NA-SP	FAZ-C5/2-NA	FAZ-C5/3-NA
6	FAZ-C6/1-NA-SP	FAZ-C6/2-NA	FAZ-C6/3-NA
7	FAZ-C7/1-NA-SP	FAZ-C7/2-NA	FAZ-C7/3-NA
8	FAZ-C8/1-NA-SP	FAZ-C8/2-NA	FAZ-C8/3-NA
10	FAZ-C10/1-NA-SP	FAZ-C10/2-NA	FAZ-C10/3-NA
13	FAZ-C13/1-NA-SP	FAZ-C13/2-NA	FAZ-C13/3-NA
15	FAZ-C15/1-NA-SP	FAZ-C15/2-NA	FAZ-C15/3-NA
16	FAZ-C16/1-NA-SP	FAZ-C16/2-NA	FAZ-C16/3-NA
20	FAZ-C20/1-NA-SP	FAZ-C20/2-NA	FAZ-C20/3-NA
25	FAZ-C25/1-NA-SP	FAZ-C25/2-NA	FAZ-C25/3-NA
30	FAZ-C30/1-NA-SP	FAZ-C30/2-NA	FAZ-C30/3-NA
32	FAZ-C32/1-NA-SP	FAZ-C32/2-NA	FAZ-C32/3-NA
35 ②	FAZ-C35/1-NA-SP	FAZ-C35/2-NA	FAZ-C35/3-NA
40 ②	FAZ-C40/1-NA-SP	FAZ-C40/2-NA	FAZ-C40/3-NA

Single-Pole



Two-Pole



Three-Pole



FAZ-RT UL 489 Circuit Breakers with Ring-Tongue Terminals— 10 kAIC, 14 kAIC C Curve (15–25A)

Amperes	Single-Pole ① Catalog Number	Two-Pole Catalog Number	Three-Pole Catalog Number
C Curve with Ring-Tongue Terminals (5–10X I_N Current Rating)			
0.5	FAZ-C0.5/1-RT-SP	FAZ-C0.5/2-RT	FAZ-C0.5/3-RT
1	FAZ-C1/1-RT-SP	FAZ-C1/2-RT	FAZ-C1/3-RT
1.5	FAZ-C1.5/1-RT-SP	FAZ-C1.5/2-RT	FAZ-C1.5/3-RT
2	FAZ-C2/1-RT-SP	FAZ-C2/2-RT	FAZ-C2/3-RT
3	FAZ-C3/1-RT-SP	FAZ-C3/2-RT	FAZ-C3/3-RT
4	FAZ-C4/1-RT-SP	FAZ-C4/2-RT	FAZ-C4/3-RT
5	FAZ-C5/1-RT-SP	FAZ-C5/2-RT	FAZ-C5/3-RT
6	FAZ-C6/1-RT-SP	FAZ-C6/2-RT	FAZ-C6/3-RT
7	FAZ-C7/1-RT-SP	FAZ-C7/2-RT	FAZ-C7/3-RT
8	FAZ-C8/1-RT-SP	FAZ-C8/2-RT	FAZ-C8/3-RT
10	FAZ-C10/1-RT-SP	FAZ-C10/2-RT	FAZ-C10/3-RT
13	FAZ-C13/1-RT-SP	FAZ-C13/2-RT	FAZ-C13/3-RT
15	FAZ-C15/1-RT-SP	FAZ-C15/2-RT	FAZ-C15/3-RT
16	FAZ-C16/1-RT-SP	FAZ-C16/2-RT	FAZ-C16/3-RT
20	FAZ-C20/1-RT-SP	FAZ-C20/2-RT	FAZ-C20/3-RT
25	FAZ-C25/1-RT-SP	FAZ-C25/2-RT	FAZ-C25/3-RT
30	FAZ-C30/1-RT-SP	FAZ-C30/2-RT	FAZ-C30/3-RT
32	FAZ-C32/1-RT-SP	FAZ-C32/2-RT	FAZ-C32/3-RT
35 ②	FAZ-C35/1-RT-SP	FAZ-C35/2-RT	FAZ-C35/3-RT
40 ②	FAZ-C40/1-RT-SP	FAZ-C40/2-RT	FAZ-C40/3-RT

Notes

- ① Option for single packaging on single-pole C and D curves only; add suffix SP when ordering.
- ② 240 Vac rated only.

FAZ-NA D Curve

- UL approved (UL 489) and CSA Certified (CSA C22.2 No.5-02) as branch circuit breakers
- Interrupting capacity: 10 kA UL/CSA; 15 kA IEC 60947-2
- Current limiting device
- UL file number E235139

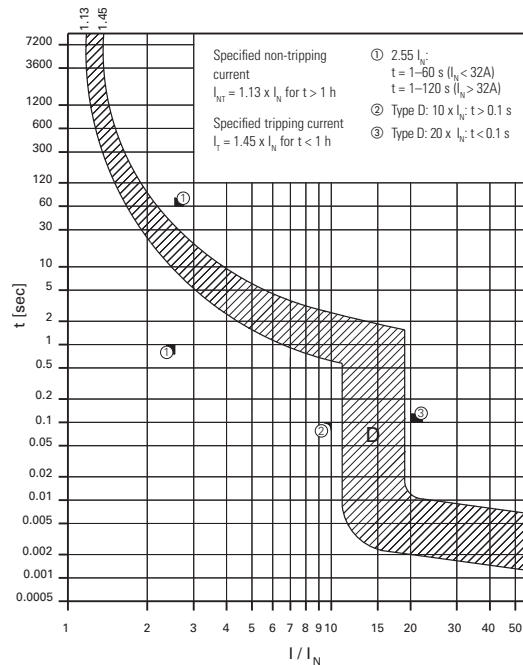

Single-Pole



Two-Pole



Three-Pole



FAZ-NA UL 489 Circuit Breakers— 10 kAIC, 14 kAIC D Curve (13–20A)

Amperes	Single-Pole ^① Catalog Number	Two-Pole Catalog Number	Three-Pole Catalog Number
D Curve (10–20X I_N Current Rating)			
0.5	FAZ-D0.5/1-NA-SP	FAZ-D0.5/2-NA	FAZ-D0.5/3-NA
1	FAZ-D1/1-NA-SP	FAZ-D1/2-NA	FAZ-D1/3-NA
1.5	FAZ-D1.5/1-NA-SP	FAZ-D1.5/2-NA	FAZ-D1.5/3-NA
2	FAZ-D2/1-NA-SP	FAZ-D2/2-NA	FAZ-D2/3-NA
3	FAZ-D3/1-NA-SP	FAZ-D3/2-NA	FAZ-D3/3-NA
4	FAZ-D4/1-NA-SP	FAZ-D4/2-NA	FAZ-D4/3-NA
5	FAZ-D5/1-NA-SP	FAZ-D5/2-NA	FAZ-D5/3-NA
6	FAZ-D6/1-NA-SP	FAZ-D6/2-NA	FAZ-D6/3-NA
7	FAZ-D7/1-NA-SP	FAZ-D7/2-NA	FAZ-D7/3-NA
8	FAZ-D8/1-NA-SP	FAZ-D8/2-NA	FAZ-D8/3-NA
10	FAZ-D10/1-NA-SP	FAZ-D10/2-NA	FAZ-D10/3-NA
13	FAZ-D13/1-NA-SP	FAZ-D13/2-NA	FAZ-D13/3-NA
15	FAZ-D15/1-NA-SP	FAZ-D15/2-NA	FAZ-D15/3-NA
16	FAZ-D16/1-NA-SP	FAZ-D16/2-NA	FAZ-D16/3-NA
20	FAZ-D20/1-NA-SP	FAZ-D20/2-NA	FAZ-D20/3-NA
25	FAZ-D25/1-NA-SP	FAZ-D25/2-NA	FAZ-D25/3-NA
30	FAZ-D30/1-NA-SP	FAZ-D30/2-NA	FAZ-D30/3-NA
32	FAZ-D32/1-NA-SP	FAZ-D32/2-NA	FAZ-D32/3-NA
35 ^②	FAZ-D35/1-NA-SP	FAZ-D35/2-NA	FAZ-D35/3-NA
40 ^②	FAZ-D40/1-NA-SP	FAZ-D40/2-NA	FAZ-D40/3-NA

Single-Pole



Two-Pole



Three-Pole



FAZ-RT UL 489 Circuit Breakers with Ring-Tongue Terminals— 10 kAIC, 14 kAIC D Curve (13–20A)

Amperes	Single-Pole ^① Catalog Number	Two-Pole Catalog Number	Three-Pole Catalog Number
D Curve with Ring-Tongue Terminals (10–20X I_N Current Rating)			
0.5	FAZ-D0.5/1-RT-SP	FAZ-D0.5/2-RT	FAZ-D0.5/3-RT
1	FAZ-D1/1-RT-SP	FAZ-D1/2-RT	FAZ-D1/3-RT
1.5	FAZ-D1.5/1-RT-SP	FAZ-D1.5/2-RT	FAZ-D1.5/3-RT
2	FAZ-D2/1-RT-SP	FAZ-D2/2-RT	FAZ-D2/3-RT
3	FAZ-D3/1-RT-SP	FAZ-D3/2-RT	FAZ-D3/3-RT
4	FAZ-D4/1-RT-SP	FAZ-D4/2-RT	FAZ-D4/3-RT
5	FAZ-D5/1-RT-SP	FAZ-D5/2-RT	FAZ-D5/3-RT
6	FAZ-D6/1-RT-SP	FAZ-D6/2-RT	FAZ-D6/3-RT
7	FAZ-D7/1-RT-SP	FAZ-D7/2-RT	FAZ-D7/3-RT
8	FAZ-D8/1-RT-SP	FAZ-D8/2-RT	FAZ-D8/3-RT
10	FAZ-D10/1-RT-SP	FAZ-D10/2-RT	FAZ-D10/3-RT
13	FAZ-D13/1-RT-SP	FAZ-D13/2-RT	FAZ-D13/3-RT
15	FAZ-D15/1-RT-SP	FAZ-D15/2-RT	FAZ-D15/3-RT
16	FAZ-D16/1-RT-SP	FAZ-D16/2-RT	FAZ-D16/3-RT
20	FAZ-D20/1-RT-SP	FAZ-D20/2-RT	FAZ-D20/3-RT
25	FAZ-D25/1-RT-SP	FAZ-D25/2-RT	FAZ-D25/3-RT
30	FAZ-D30/1-RT-SP	FAZ-D30/2-RT	FAZ-D30/3-RT
32	FAZ-D32/1-RT-SP	FAZ-D32/2-RT	FAZ-D32/3-RT
35 ^②	FAZ-D35/1-RT-SP	FAZ-D35/2-RT	FAZ-D35/3-RT
40 ^②	FAZ-D40/1-RT-SP	FAZ-D40/2-RT	FAZ-D40/3-RT

Notes

- ① Option for single packaging on single-pole C and D curves only; add suffix SP when ordering.
- ② 240 Vac rated only.

1.2

Miniature Circuit Breakers and Supplementary Protectors

UL 489 DIN Rail Miniature Circuit Breakers

1

FAZ-NA-DC C Curve

- UL approved (UL 489) and CSA Certified (CSA C22.2 No.5-02) as Branch Circuit Breakers
- Interrupting capacity: 10 kA at 125 Vdc UL/CSA, 10 kA at 250 Vdc
- 125 Vdc for one-pole, 250 Vdc for two-pole in series
- Current limiting device
- Polarity (+/-) sensitive and not for use on photovoltaic string application
- UL file number E235139

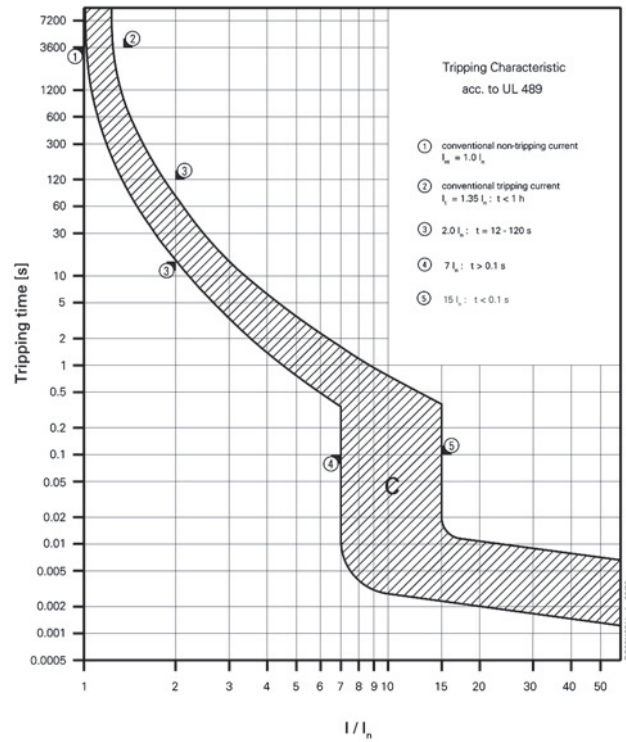

Single-Pole



Two-Pole



FAZ-NA-DC UL 489 Circuit Breakers— 10 kAIC at 125 Vdc Per Pole





Amperes	Single-Pole ① Catalog Number	Two-Pole Catalog Number
C Curve (5–10X I_n Current Rating)		
2	FAZ-C2/1-NA-DC-SP	FAZ-C2/2-NA-DC
3	FAZ-C3/1-NA-DC-SP	FAZ-C3/2-NA-DC
4	FAZ-C4/1-NA-DC-SP	FAZ-C4/2-NA-DC
5	FAZ-C5/1-NA-DC-SP	FAZ-C5/2-NA-DC
6	FAZ-C6/1-NA-DC-SP	FAZ-C6/2-NA-DC
7	FAZ-C7/1-NA-DC-SP	FAZ-C7/2-NA-DC
8	FAZ-C8/1-NA-DC-SP	FAZ-C8/2-NA-DC
10	FAZ-C10/1-NA-DC-SP	FAZ-C10/2-NA-DC
13	FAZ-C13/1-NA-DC-SP	FAZ-C13/2-NA-DC
15	FAZ-C15/1-NA-DC-SP	FAZ-C15/2-NA-DC
16	FAZ-C16/1-NA-DC-SP	FAZ-C16/2-NA-DC
20	FAZ-C20/1-NA-DC-SP	FAZ-C20/2-NA-DC
25	FAZ-C25/1-NA-DC-SP	FAZ-C25/2-NA-DC
30	FAZ-C30/1-NA-DC-SP	FAZ-C30/2-NA-DC
32	FAZ-C32/1-NA-DC-SP	FAZ-C32/2-NA-DC
35	FAZ-C35/1-NA-DC-SP	FAZ-C35/2-NA-DC
40	FAZ-C40/1-NA-DC-SP	FAZ-C40/2-NA-DC

Note



① Option for single packaging on single-pole C curves only; add suffix SP when ordering.

Accessories

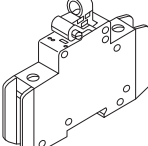
FAZ-NA UL 489 Breakers

	Description	Catalog Number
Contact 	Two-pole contact or auxiliary contact/trip indicating contact	Z-NHK ①
Auxiliary Contact 	Auxiliary contact	Z-IHK-NA
Shunt Trip  	Shunt trip 110–415 Vac Shunt trip 12–110 Vac	FAZ-XAA-NA110-415VAC FAZ-XAA-NA12-110VAC
Padlock Hasp 	Padlock hasp	IS/SPE-1TE

FAZ-NA UL 489 Breakers, continued

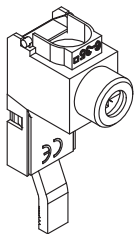
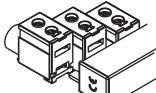
	Description	Catalog Number
Busbar 	Busbar—single-pole, 6 terminals ②③④⑤	Z-SV/UL-16/1P-1TE/6
	Busbar—single-pole, 12 terminals ②③④⑤	Z-SV/UL-16/1P-1TE/12
	Busbar—single-pole, 18 terminals ②③④⑤	Z-SV/UL-16/1P-1TE/18
	Busbar—two-pole, 6 terminals ②③④⑤	Z-SV/UL-16/2P-2TE/6
	Busbar—two-pole, 12 terminals ②③④⑤	Z-SV/UL-16/2P-2TE/12
	Busbar—two-pole, 18 terminals ②③④⑤	Z-SV/UL-16/2P-2TE/18
	Busbar—three-pole, 6 terminals ②③④⑤	Z-SV/UL-16/3P-3TE/6
	Busbar—three-pole, 12 terminals ②③④⑤	Z-SV/UL-16/3P-3TE/12
	Busbar—three-pole, 18 terminals ②③④⑤	Z-SV/UL-16/3P-3TE/18
Busbar Shroud 	Three-pole busbar shroud	ZV-BS-UL
Extension Terminal 	Extension terminal—35 mm ² (2–14 AWG)	Z-EK/35/UL
Bus Connector 	Bus connector—conductors up to 50 mm ² (–1/0 AWG)	Z-EB/50/UL

Notes

- ① Voltage of FAZ-NA circuit breaker is limited to 300V with this auxiliary contact installed.
- ② Do not cut commoning link.
- ③ A maximum of three commoning links may be used in conjunction. Each breaker connected to the commoning link must have the same number of poles for proper use.
- ④ Not for use with ring-tongue circuit breakers.
- ⑤ Bus may be center fed for high current capacity.

1.2

Miniature Circuit Breakers and Supplementary Protectors

UL 489 DIN Rail Miniature Circuit Breakers

1

Tripping Signal Switch Z-NHK, Z-IHK-NA

- Design according to IEC/EN 60947-5-1, IEC/EN 62019
- Field installable
- The specified minimum voltages are per contact—take into account particularly in case of series connection
- Self-cleaning contacts
- Contact material and design particularly suitable for extra low voltage
- Z-NHK: the function of one of the two change-over contacts can be switched from “auxiliary switch” to “tripping signal switch”
- Tripping signal contact transmits message of electric tripping, not mechanical switch-off
- Test key for contact function “electrical tripping”
- Z-IHK-NA: will allow for > 480Y/277 Vac rating

Connection Diagram

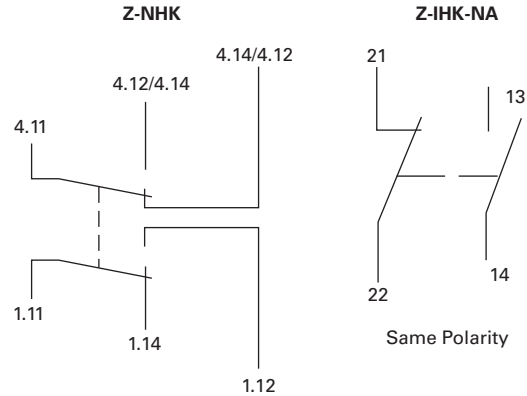

Busbar Connection Example

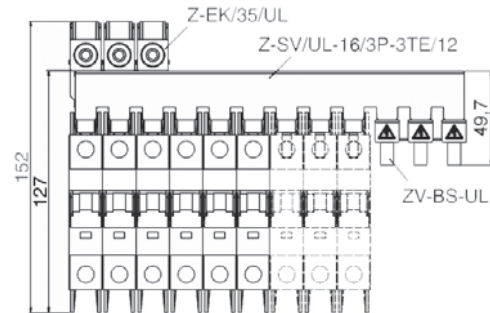

Technical Data and Specifications

Trip Curve Chart

Eaton FAZ-NA branch circuit breakers are available with "B," "C" and "D" tripping characteristics. B-curve devices are suitable for applications where low levels of inrush current are expected.

C-curve devices are suitable for applications where medium levels of inrush current are expected. Applications include small transformers, lighting, pilot devices, control circuits and coils. C-curve devices provide a medium magnetic trip point.

D-curve devices are suitable for applications where high levels of inrush current are expected. The high magnetic trip point prevents nuisance tripping in high inductive applications such as motors, transformers and power supplies.

Eaton FAZ-NA devices are current limiting, which means they interrupt fault currents within one half cycle of the fault. Current limiting devices offer superior protection by reducing peak let-through current and energy.

Tripping Characteristics

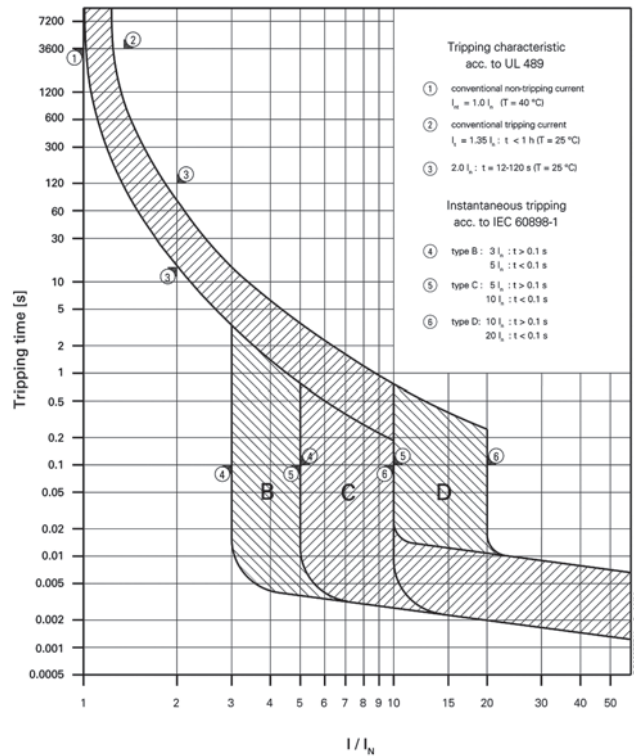

Connection Diagrams

Single-Pole



Two-Pole

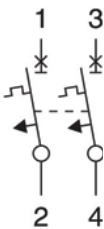

Three-Pole

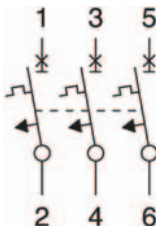

Miniature Circuit Breakers FAZ-NA Technical Data

Description	Specification
Electrical	
Design according to	UL 489, CSA C22.2 No.5, IEC 60947-2
Rated voltage FAZ-NA UL/CSA	10 kAIC at 277/480V from 0.5A to 32A 14 kAIC at select amperages B and C Curves (15–25A), D Curve (13–20A)
UL/CSA	10 kAIC at 240 Vac for 35A and 40A
UL/CSA	10 kAIC at 48 Vdc per pole
IEC 947-2	15 kAIC at 240/415 Vac
Rated voltage FAZ-NA-DC UL/CSA	10 kAIC at 125 Vdc per pole (two poles maximum) 10 kAIC at 250 Vdc with two poles connected in series
Rated frequency	50/60 Hz
Characteristic	B, C, D
Endurance	≥ 20,000 operations
Line voltage connection	Suitable for reverse feed
Mechanical	
Frame size	45 mm
Device height	105 mm
Device width	17.7 mm per pole
Terminal protection	Finger and hand touch safe according to BGV A3, OVE-EN 6
Mounting	Quick fastening with two lock-in positions on IEC/EN 60715
Upper and lower terminals	Open mouth/lift terminals
Terminal capacity	One wire: AWG 18–6 Two wires: AWG 18–10
Terminal fastening torque	AWG 18–21: 21 lb-in AWG 10–8: 25 lb-in AWG 6: 36 lb-in
Mounting	Independent of position
Calibration temperature UL 489, CSA C22.2 No.5	40°C
IEC 60947-2	30°C

Power Loss at I_n

I_n [A]	Characteristic B			Characteristic C			Characteristic D		
	Single-Pole P [W]	Two-Pole P [W]	Three-Pole P [W]	Single-Pole P [W]	Two-Pole P [W]	Three-Pole P [W]	Single-Pole P [W]	Two-Pole P [W]	Three-Pole P [W]
0.5	—	—	—	1.6	3.2	4.7	1.6	3.2	4.8
1.0	1.1	2.2	3.4	1.1	2.2	3.4	0.8	1.5	2.3
1.5	2.2	4.4	6.6	1.3	2.6	3.9	1.0	2.1	3.1
2.0	1.4	2.8	4.3	1.4	2.8	4.3	1.0	2.1	3.1
3.0	2.1	4.2	6.4	1.2	2.4	3.6	1.2	2.4	3.6
4.0	1.4	2.9	4.3	1.4	2.9	4.3	1.4	2.9	4.3
5.0	1.8	3.7	5.5	1.9	3.7	5.6	1.5	2.9	4.4
6.0	1.7	3.5	5.2	1.2	2.3	3.5	1.2	2.3	3.5
7.0	2.0	4.0	6.0	1.4	2.8	4.3	1.4	2.8	4.3
8.0	2.0	3.9	5.9	1.4	2.8	4.2	1.2	2.4	3.7
10.0	1.8	3.6	5.3	1.8	3.6	5.3	1.5	3.0	4.5
13.0	2.4	4.7	7.1	2.4	4.7	7.1	2.0	4.1	6.1
15.0	1.9	3.8	5.6	1.9	3.8	5.6	1.5	3.1	4.6
16.0	2.1	4.3	6.4	2.1	4.3	6.4	1.7	3.5	5.2
20.0	2.9	5.8	8.7	2.9	5.8	8.7	1.8	3.7	5.5
25.0	3.1	6.2	9.3	3.1	6.2	9.3	2.6	5.1	7.7
30.0	3.0	6.0	9.0	3.0	6.0	9.0	2.7	5.4	8.1
32.0	3.4	6.8	10.2	3.4	6.8	10.2	3.1	6.2	9.3
35.0	4.0	8.1	12.1	3.7	7.4	11.0	3.8	7.6	11.3
40.0	4.0	8.1	12.1	4.0	8.1	12.1	3.9	7.8	11.6

1.2

Miniature Circuit Breakers and Supplementary Protectors

UL 489 DIN Rail Miniature Circuit Breakers

1

Let-Through Energy

Characteristic B (1–32A), 277V

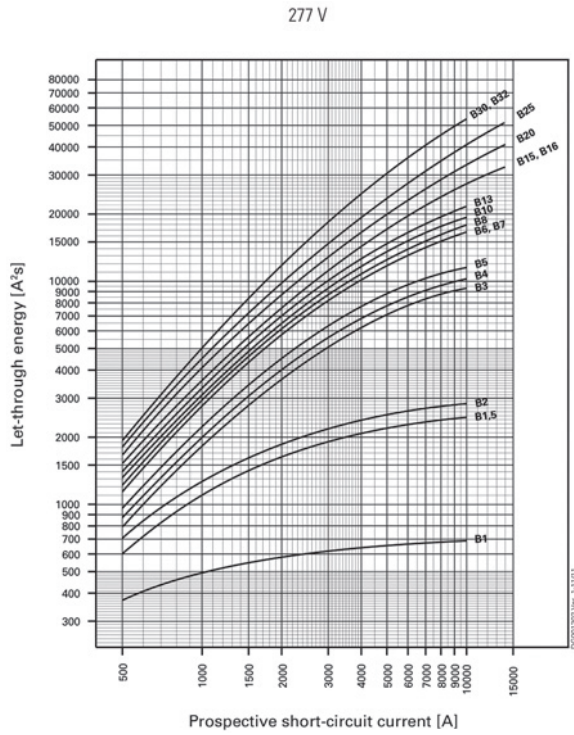

Characteristic B (35–40A), 240V

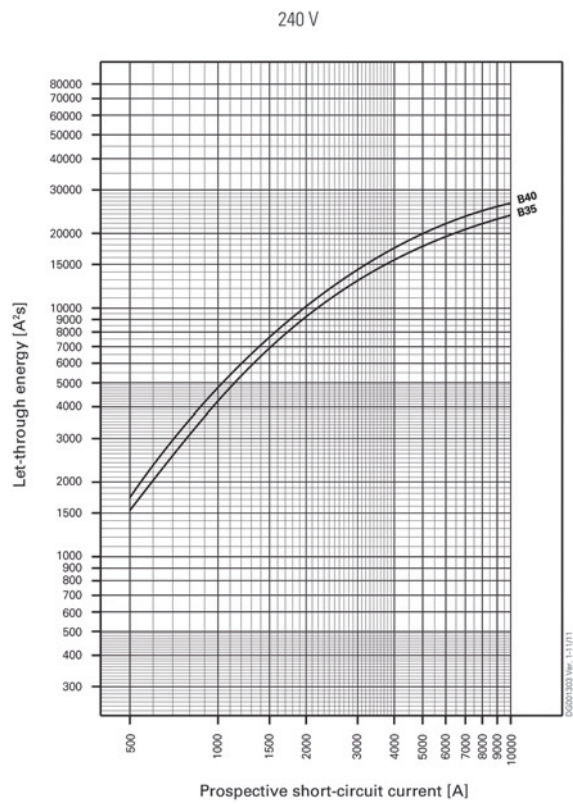

Characteristic C (0.5–32A), 277V

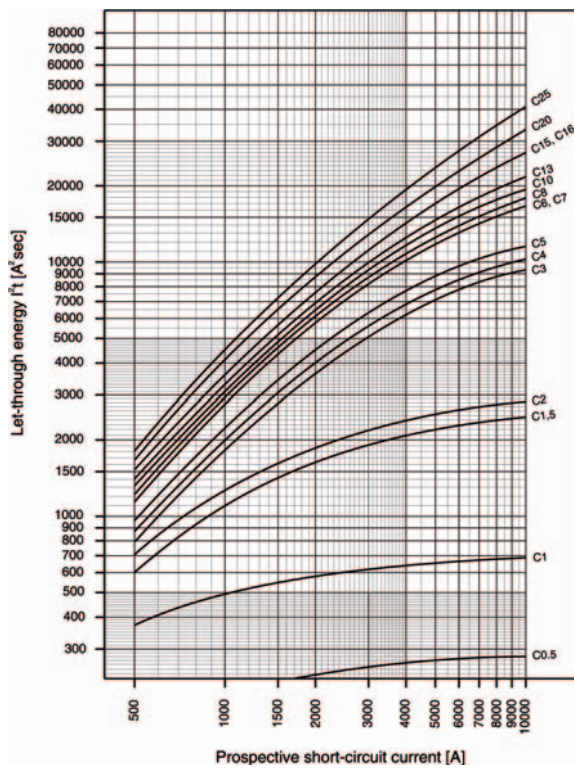

Characteristic C (40A), 240V

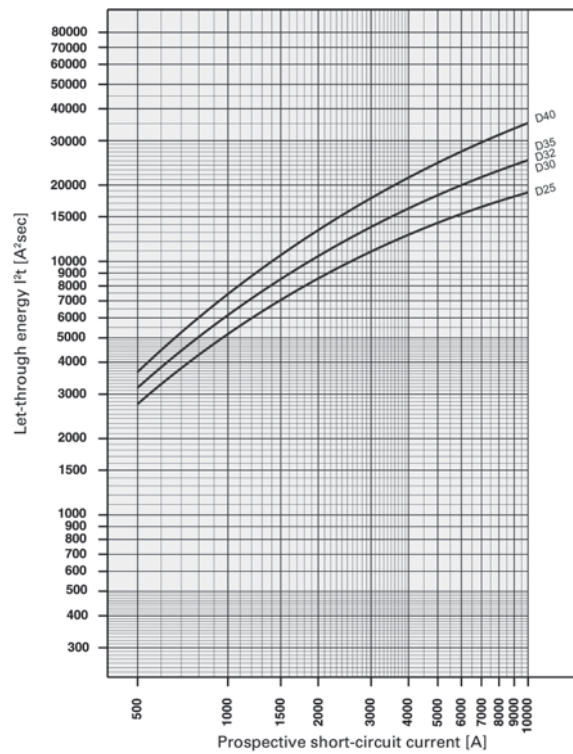

Characteristic D (0.5–32A), 277V

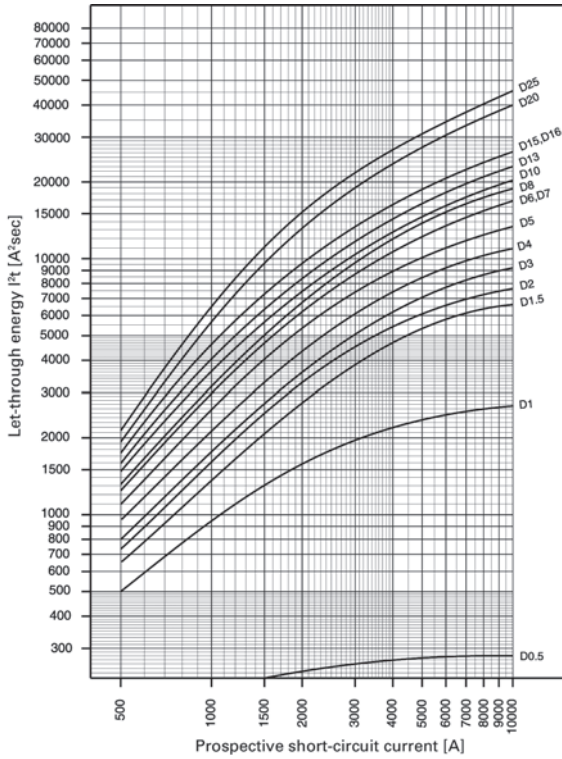

Characteristic D (40A), 240V

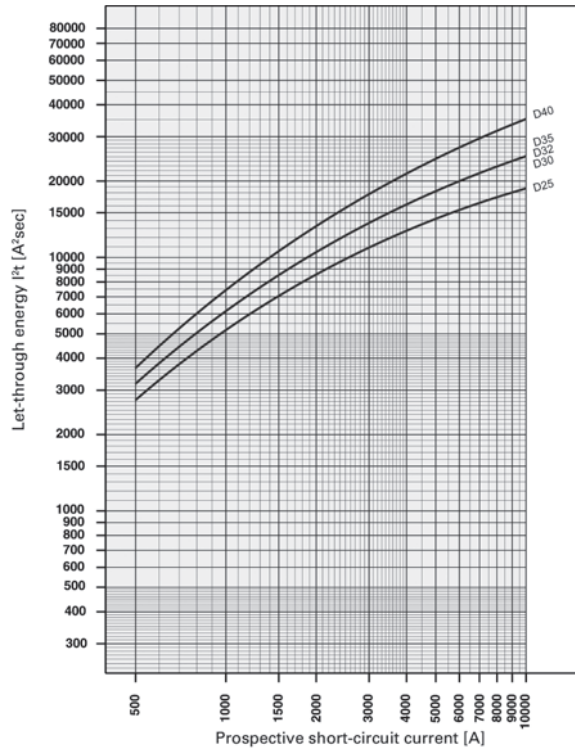

1.2

Miniature Circuit Breakers and Supplementary Protectors

UL 489 DIN Rail Miniature Circuit Breakers

1

Influence of Ambient Temperature T on Load Carrying Capacity

Device Market Current Rating I_n (A) at 40°C	I_n (A) at Higher Ambient Temperature							
	15°C	20°C	25°C	30°C	40°C	50°C	55°C	60°C
0.5	0.6	0.5	0.5	0.5	0.5	0.5	0.5	0.5
1.0	1.1	1.1	1.1	1.0	1.0	1.0	0.9	0.9
1.5	1.7	1.6	1.6	1.6	1.5	1.4	1.4	1.4
2.0	2.2	2.2	2.1	2.1	2.0	1.9	1.9	1.8
3.0	3.3	3.2	3.2	3.1	3.0	2.9	2.9	2.8
4.0	4.4	4.3	4.2	4.2	4.0	3.8	3.8	3.7
5.0	5.5	5.4	5.3	5.2	5.0	4.8	4.7	4.6
6.0	6.6	6.5	6.4	6.2	6.0	5.8	5.6	5.5
7.0	7.7	7.6	7.4	7.3	7.0	6.7	6.6	6.4
8.0	8.8	8.6	8.5	8.3	8.0	7.7	7.5	7.4
10.0	11.0	10.8	10.6	10.4	10.0	9.6	9.4	9.2
13.0	14.3	14.0	13.8	13.5	13.0	12.5	12.5	12.0
15.0	16.5	16.2	15.9	15.6	15.0	14.4	14.1	13.8
16.0	17.6	17.3	17.0	16.6	16.0	15.4	15.0	14.7
20.0	22.0	21.6	21.2	20.8	20.0	19.2	18.8	18.4
25.0	27.5	27.0	26.5	26.0	25.0	24.0	23.3	23.0
30.0	33.0	32.4	31.8	31.2	30.0	28.8	28.2	27.6
32.0	35.2	34.6	33.9	33.3	32.0	30.7	30.1	29.4
40.0	44.0	43.2	42.4	41.6	40.0	38.4	37.6	36.8

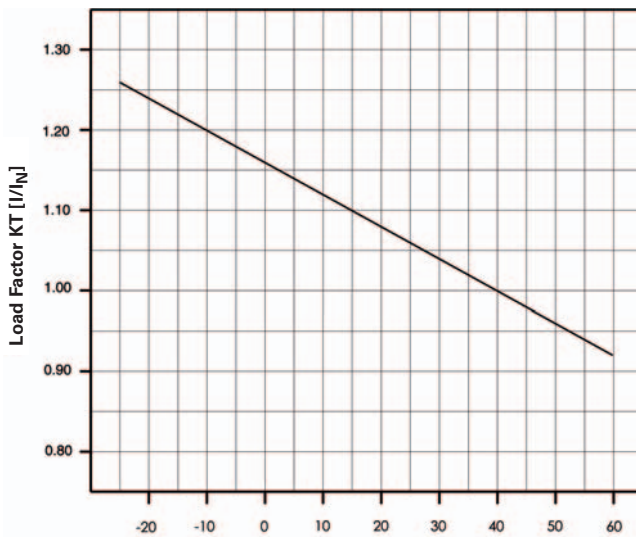

Maximum Load I_L at ambient temperature T: $I_L(T) = I_N K_T(T)$

Load Carrying Capacity of Adjoining Miniature Circuit Breakers

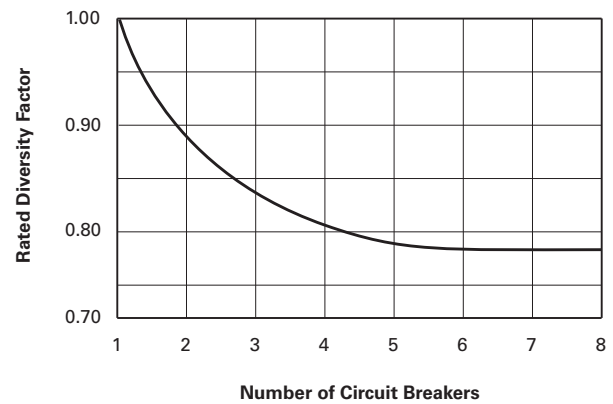

Z-NHK



Z-IHK-NA



Contact and Auxiliary Contact

Description	Z-NHK	Z-IHK-NA
Electrical		
Contact function	2C0	1N0 + 1NC
Rated voltage	230V	250V
Frequency	50/60 Hz	50/60 Hz
Rated current	2A	6A
Rated thermal current I_{th}	2A	6A
Utilization category AC13 Rated operational current I_b	3A/250 Vac	3A/250 Vac
Utilization category AC15 Rated operational current I_b	2A/250 Vac	2A/250 Vac
Utilization category DC12 Rated operational current I_b	0.5A/110 Vdc	0.5A/110 Vdc 0.25A/220 Vdc
Rated insulation voltage U_i	250 Vac	250 Vac
Minimum operational voltage per contact U_{min}	5 Vdc	5 Vdc
Minimum operational current I_{min}	10 mA DC	10 mA AC/DC
Rated peak withstand voltage U_{imp} (1.2/50 μ)	2.5 kV	4 kV
Conditional short-circuit current I_k with backup fuse 6A	1 kA	1 kA
Max. backup fuse, overload and short circuit	6A gL	—
Mechanical		
Tripping indicator "electrical tripping"	Blue/white	—
Frame size	45 mm	45 mm
Device height	80 mm	80 mm
Device width	8.8 mm (0.5MU)	8.8 mm (0.5MU)
Mounting	Onto switching device	—
Degree of protection, built-in	IP40	IP40
Terminal protection	Finger and hand touch safe According to BGV A3, ÖVE-EN 6	Finger and hand touch safe According to BGV A3, ÖVE-EN 6
Terminals	Lift terminals	Lift terminals
Terminal capacity	20–14 AWG	0.5–2.5 mm ²
Terminal screws	M3 (Posidrive Z0)	M3 (Posidrive Z0)
Fastening torque of terminal screws	7 lb-in	Max. 1.2 Nm

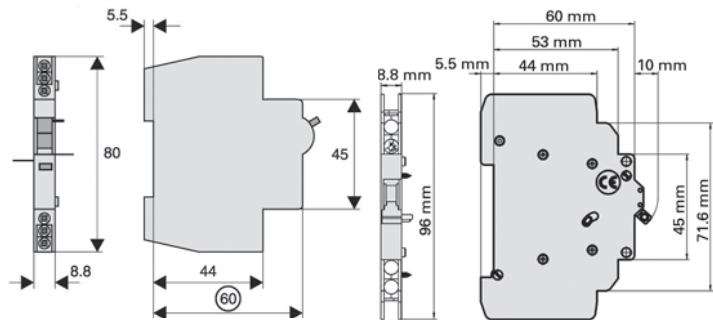

Shunt trip release FAZ-XAA-NA

- Remote release for subsequent mounting onto FAZ-NA/RT
- Additional installation of standard auxiliary switch is possible
- Position indicator red–green

Connection Diagram

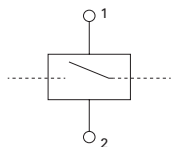

Shunt Trip Release FAZ-XAA-NA

Description	FAZ-XAA-NA12-110VAC	FAZ-XAA-NA110-415VAC
Electrical		
Can be mounted onto	FAZ-NA / FAZ-NA-DC / FAZ-RT	FAZ-NA / FAZ-NA-DC / FAZ-RT
Operational voltage range	12–110 Vac 12–60 Vdc	110–415 Vac 110–230 Vdc
Frequency	50/60 Hz	50/60 Hz
Mechanical		
Frame size	45 mm	45 mm
Device height	105 mm	105 mm
Device width	17.5 mm	17.5 mm
Mounting	Quick fastening with two lock-in positions on EN 50022	
Degree of protection, built-in	IP40	IP40
Terminal protection	Finger and hand touch safe according to BGV A3, ÖVE-EN 6	
Terminals	Open mouthed/lift	Open mouthed/lift
Terminal capacity One and two wires	18–10 AWG	18–10 AWG

Busbar block UL 489 (pin)

- Tested according to UL 489
- Do not cut
- Extension terminal 35 mm² Z-EK/35/UL for copper conductors
- Incoming terminal 50 mm² Z-EB/50/UL
- For covering of not used pins, use busbar tag shrouds ZV-BS-UL

Connection Diagrams

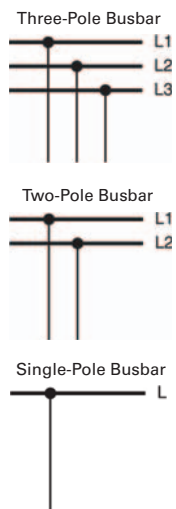

Busbar Block UL 489 (Pin)

Description	UL 489	IEC/EN 60947-2
Electrical		
Rated operational voltage	480/277 Vac 96 Vdc	—
Rated frequency	50/60 Hz	—
Rated voltage	480 Vac	690 Vac
Overvoltage category	—	III
Rated impulse withstand voltage U _{imp}	—	9.5 kV
Rated current	80A at 40°C	80A at 30°C
Rated conditional short-circuit current AC with 350A gG	—	15 kA
Short-circuit current	10 kA	—
Mechanical		
Busbar cross section	—	16 mm ² Cu
Flame class according to UL 94	V0	—
Pollution degree	—	2
Comparative tracking index	—	CTI 600
Minimum clearance (internal/external)	—	> 9.5/25.4 mm
Minimum creepage distance (internal/external)	—	> 12.7/50.8 mm
Resistance to climatic conditions	—	According to DIN/EN 60068

Application Guidelines

Example of UL 489 and UL 1077 Application

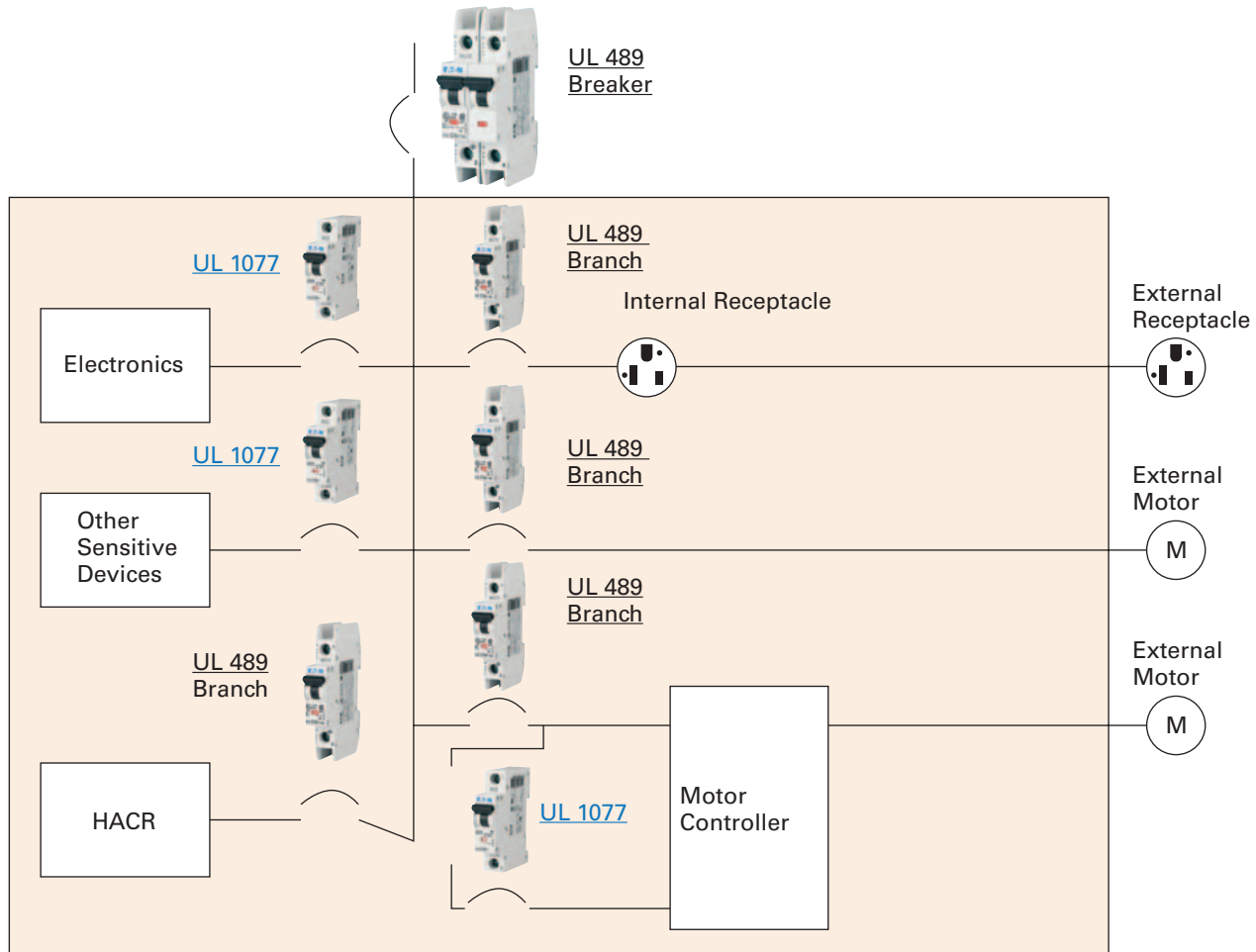

Example of UL 489 and UL 1077 Application

UL 489 circuit breakers

Used for branch circuit protection, internal/external receptacles, external motors and HACR equipment (heating, air conditioning and refrigeration).

UL 1077 supplementary protectors

Used for overcurrent protection within appliances or electrical equipment, where branch circuit protection is already provided or not required.

Note: UL 489 devices can be used in place of UL 1077; UL 1077 devices cannot be used in place of UL 489.

1.2

Miniature Circuit Breakers and Supplementary Protectors

UL 489 DIN Rail Miniature Circuit Breakers

1

Dimensions

Approximate Dimensions in Inches (mm)

Miniature Circuit Breakers

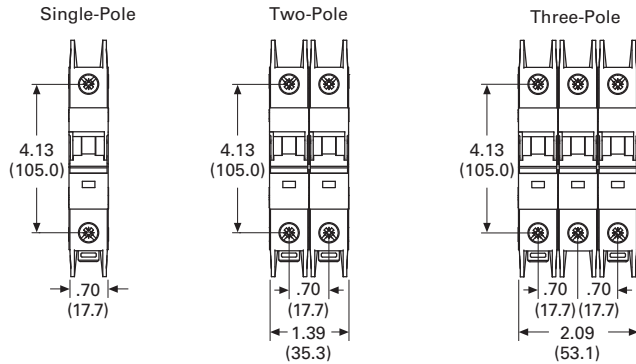

Lockout Attachment—IS/SPE-ITE

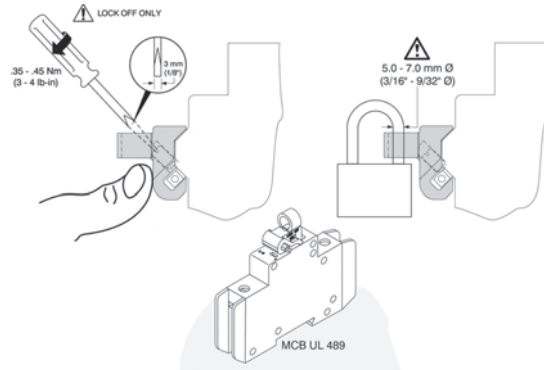

Accessories

Z-SV/UL-16/6

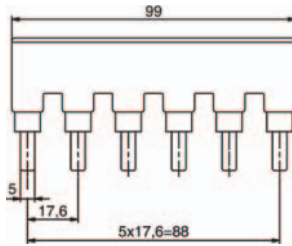

Z-SV/UL-18...12

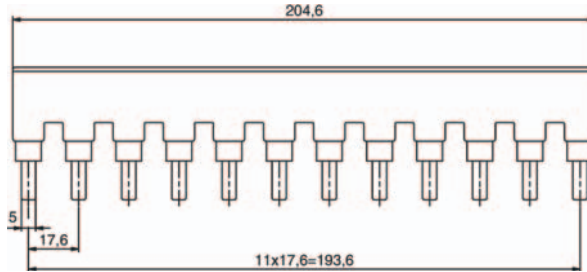

ZV-BS-UL

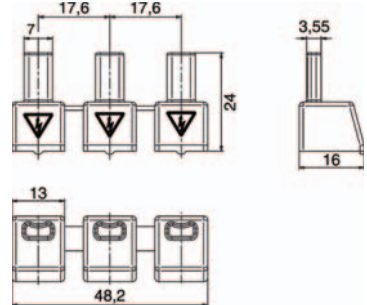

Z-SV/UL-16.../18

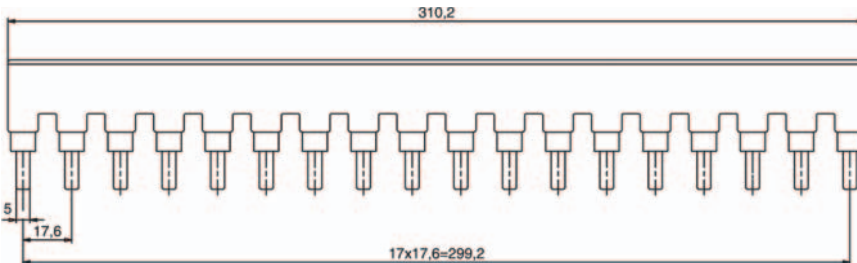

Z-EK/35/UL

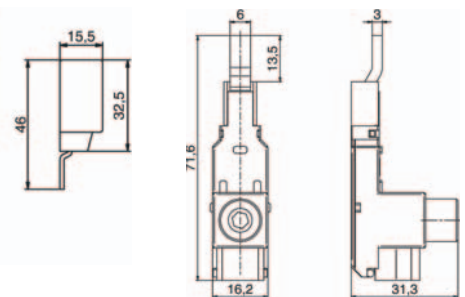

Z-EK/35/UL

Description	UL 489	IEC/EN 60947-2
U_e	480 Vac/96 Vdc	240/415 Vac
f	50/60 Hz	50/60 Hz
U_{imp}	—	9.5 kV
I_e	80A at 40°C	80A at 30°C
	#2-14 AWG 60/75°C Cu	2.5-35 mm ² Cu
	0.56 in	14 mm

Z-EB/50/UL

Description	UL 489	IEC/EN 60947-2
U_e	480 Vac/96 Vdc	240/415 Vac
f	50/60 Hz	50/60 Hz
U_{imp}	—	9.5 kV
I_e	115A at 40°C	160A at 30°C
	#1-14 AWG 60/75°C Cu	1.5-50 mm ² Cu
	0.56 in	14 mm

FAZ Circuit Breakers



Optimum and Efficient Protection for Every Application

Contents

Description

<i>Description</i>	<i>Page</i>
FAZ Circuit Breakers	V4-T1-67
Catalog Number Selection	V4-T1-68
Standards and Certifications	V4-T1-68
Product Selection	V4-T1-69
Accessories	V4-T1-75
Technical Data and Specifications	V4-T1-78
Dimensions	V4-T1-85

FAZ Circuit Breakers

Product Overview

Optimum product quality, tested reliability and safety stand for best protection of personnel, installations and plant. Eaton’s FAZ DIN rail mountable circuit breaker is designed for use in control panel applications.

Powerful offering for machine and system builders

The FAZ is available with B, C, D, K, S, and Z characteristics in accordance with UL 1077, CSA C22.2 No.235 and IEC 60947-2. These devices are CE marked.

Application Description

- Supplementary protection
- Control circuits
- Lighting
- Business equipment
- Appliances

Features

- Complete range of UL 1077 recognized DIN rail mounted miniature circuit breakers up to 63A current rating
- Standard ratings of 10 kAIC up to 277/480 Vac
- Current limiting design provides fast short-circuit interruption that reduces the let-through energy, which can damage the circuit
- Suitable for supplementary protection
- Thermal-magnetic overcurrent protection
 - Six levels of short-circuit protection, categorized by B, C, D, K, S, and Z curves
- Trip-free design—breaker can not be defeated by holding the handle in the ON position
- Captive screws cannot be lost
- Fulfill UL 1077, CSA C22.2 No.235 and also IEC 60947-2 Standard
- Field-installable shunt trip and auxiliary switch subsequent mounting
- Module width of only 17.7 mm (per pole)
- Contact position indicator (red/green)
- Easy installation on DIN rail
- Possibility for sealing the toggle in ON or OFF position

1.3

Miniature Circuit Breakers and Supplementary Protectors

UL 1077 DIN Rail Supplementary Protectors

1

Discover These Advanced Features

Breakers install on standard DIN rail

Available in one-, two-, three-, four-pole, 1+N and 3+N models

Color-coded indicator provides breaker status for easy troubleshooting



Captive Posidrive terminal screws with finger and back-of-hand protection (IP20)

Trip-free design; breaker cannot be defeated by holding the handle in the ON position

Breaker information printed on the front of the device for quick identification

Standards and Certifications

FAZ complies with the latest national and international standards.

- UL 1077, CSA C22.2 No. 235
- Apply to supplementary protectors intended for use as overcurrent, or overvoltage or undervoltage protection within an appliance or other electrical equipment where branch circuit protection is already provided, or is not required

- RoHS compliant
- VDE compliant
 - Devices with B, C, and D curves are VDE compliant
- CCC
 - Devices with B, C, and D curves are CCC compliant
- ABS compliant



Catalog Number Selection

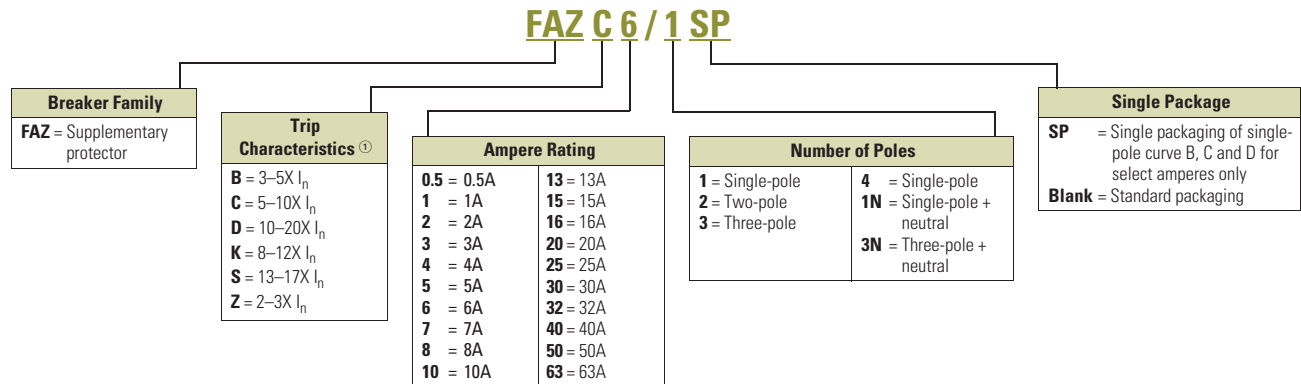

Note

① I_n = Rated current for instantaneous trip characteristics.

Product Selection

FAZ B curve (3–5X I_n current rating)

- Designed for resistive or slightly inductive loads
- Response time of instantaneous trip: 3–5X I_n current rating
- UL recognized and CSA Certified as supplementary protectors
- For international and domestic use (conform to IEC 60947-2)
- UL file number 177451

Suitable for applications where protection against low-level short-circuit faults in control wiring is desired. Instantaneous trip is 3–5X continuous rating of device (I_n). Applications include PLC wiring, business equipment, lighting, appliances and some motors. Low magnetic trip point.

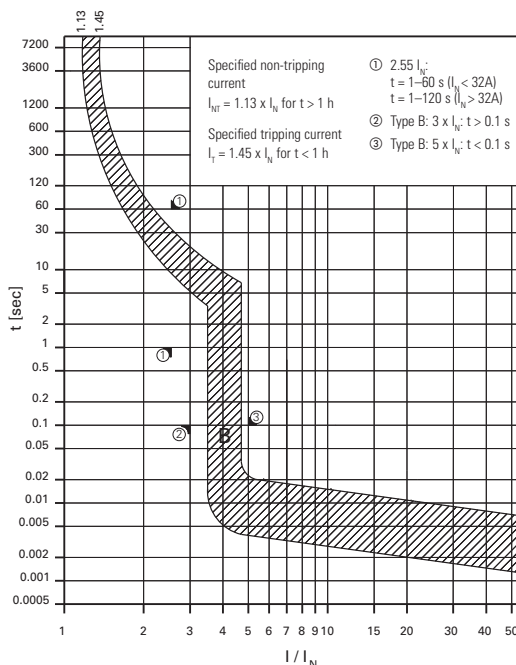

Single-Pole



Two-Pole



Three-Pole



B Curve (3–5X I_n Current Rating)— Designed for Resistive or Slightly Inductive Loads ①

Amperes	Single-Pole ② Catalog Number	Two-Pole Catalog Number	Three-Pole Catalog Number
1	FAZ-B1/1-SP	FAZ-B1/2	FAZ-B1/3
2	FAZ-B2/1-SP	FAZ-B2/2	FAZ-B2/3
3	FAZ-B3/1-SP	FAZ-B3/2	FAZ-B3/3
4	FAZ-B4/1-SP	FAZ-B4/2	FAZ-B4/3
5	FAZ-B5/1-SP	FAZ-B5/2	FAZ-B5/3
6	FAZ-B6/1-SP	FAZ-B6/2	FAZ-B6/3
7	FAZ-B7/1-SP	FAZ-B7/2	FAZ-B7/3
8	FAZ-B8/1-SP	FAZ-B8/2	FAZ-B8/3
10	FAZ-B10/1-SP	FAZ-B10/2	FAZ-B10/3
12	FAZ-B12/1-SP	FAZ-B12/2	FAZ-B12/3
13	FAZ-B13/1-SP	FAZ-B13/2	FAZ-B13/3
15	FAZ-B15/1-SP	FAZ-B15/2	FAZ-B15/3
16	FAZ-B16/1-SP	FAZ-B16/2	FAZ-B16/3
20	FAZ-B20/1-SP	FAZ-B20/2	FAZ-B20/3
25	FAZ-B25/1-SP	FAZ-B25/2	FAZ-B25/3
30	FAZ-B30/1-SP	FAZ-B30/2	FAZ-B30/3
32	FAZ-B32/1-SP	FAZ-B32/2	FAZ-B32/3
40	FAZ-B40/1-SP	FAZ-B40/2	FAZ-B40/3
50	FAZ-B50/1-SP	FAZ-B50/2	FAZ-B50/3
63	FAZ-B63/1-SP	FAZ-B63/2	FAZ-B63/3

Four-Pole



Single-Pole + Neutral



Three-Pole + Neutral



B Curve (3–5X I_n Current Rating)— Designed for Resistive or Slightly Inductive Loads, continued ①

Amperes	Four-Pole Catalog Number	Single-Pole + Neutral Catalog Number	Three-Pole + Neutral Catalog Number
1	FAZ-B1/4	FAZ-B1/1N	FAZ-B1/3N
2	FAZ-B2/4	FAZ-B2/1N	FAZ-B2/3N
3	FAZ-B3/4	FAZ-B3/1N	FAZ-B3/3N
4	FAZ-B4/4	FAZ-B4/1N	FAZ-B4/3N
5	FAZ-B5/4	FAZ-B5/1N	FAZ-B5/3N
6	FAZ-B6/4	FAZ-B6/1N	FAZ-B6/3N
7	FAZ-B7/4	FAZ-B7/1N	FAZ-B7/3N
8	FAZ-B8/4	FAZ-B8/1N	FAZ-B8/3N
10	FAZ-B10/4	FAZ-B10/1N	FAZ-B10/3N
12	FAZ-B12/4	FAZ-B12/1N	FAZ-B12/3N
13	FAZ-B13/4	FAZ-B13/1N	FAZ-B13/3N
15	FAZ-B15/4	FAZ-B15/1N	FAZ-B15/3N
16	FAZ-B16/4	FAZ-B16/1N	FAZ-B16/3N
20	FAZ-B20/4	FAZ-B20/1N	FAZ-B20/3N
25	FAZ-B25/4	FAZ-B25/1N	FAZ-B25/3N
30	FAZ-B30/4	FAZ-B30/1N	FAZ-B30/3N
32	FAZ-B32/4	FAZ-B32/1N	FAZ-B32/3N
40	FAZ-B40/4	FAZ-B40/1N	FAZ-B40/3N
50	FAZ-B50/4	FAZ-B50/1N	FAZ-B50/3N
63	FAZ-B63/4	FAZ-B63/1N	FAZ-B63/3N

Notes

- ① In North America, these switches are UL recognized and CSA Certified as supplementary protection devices. Per the intent of NEC (National Electrical Code), Article 240, and CEC (Canadian Electrical Code), Part 1 C22.1, supplementary breakers cannot be used as a substitute for the branch circuit protective device. They can be used to provide overcurrent protection within an appliance or other electrical equipment where branch circuit overcurrent protection is already provided, or is not required.
- ② Option for single packaging on single-pole B, C and D curves only; add suffix SP when ordering.

1.3

Miniature Circuit Breakers and Supplementary Protectors

UL 1077 DIN Rail Supplementary Protectors

1

FAZ C curve (5–10X I_n current rating)

- Designed for inductive loads
- Response time of instantaneous trip: 5–10X I_n current rating
- UL recognized and CSA Certified as supplementary protectors
- For international and domestic use (conform to IEC 60947-2)
- UL file number 177451

Suitable for applications where medium levels of inrush current are expected. Instantaneous trip is 5–10X rating of device (I_n). Applications include small transformers, lighting, pilot devices, control circuits and coils. Medium magnetic trip point.

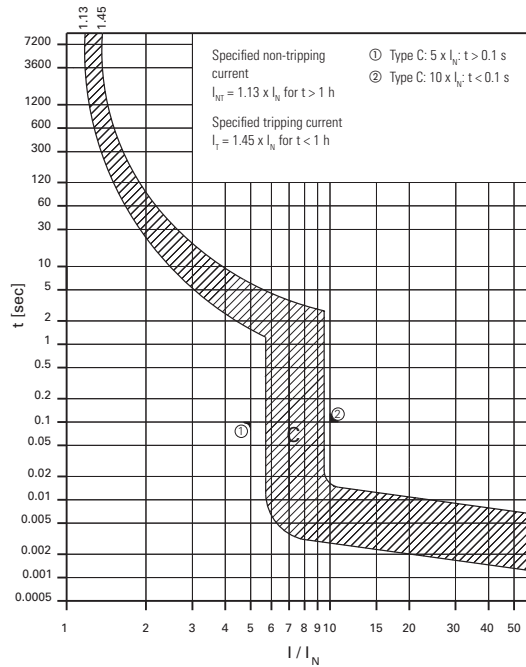

Single-Pole



C Curve (5–10X I_n Current Rating)—Designed Inductive Loads^①

Amperes	Single-Pole ^② Catalog Number	Two-Pole Catalog Number	Three-Pole Catalog Number
0.5	FAZ-C0.5/1-SP	FAZ-C0.5/2	FAZ-C0.5/3
1	FAZ-C1/1-SP	FAZ-C1/2	FAZ-C1/3
1.6	FAZ-C1.6/1-SP	FAZ-C1.6/2	FAZ-C1.6/3
2	FAZ-C2/1-SP	FAZ-C2/2	FAZ-C2/3
3	FAZ-C3/1-SP	FAZ-C3/2	FAZ-C3/3
4	FAZ-C4/1-SP	FAZ-C4/2	FAZ-C4/3
5	FAZ-C5/1-SP	FAZ-C5/2	FAZ-C5/3
6	FAZ-C6/1-SP	FAZ-C6/2	FAZ-C6/3
7	FAZ-C7/1-SP	FAZ-C7/2	FAZ-C7/3
8	FAZ-C8/1-SP	FAZ-C8/2	FAZ-C8/3
10	FAZ-C10/1-SP	FAZ-C10/2	FAZ-C10/3
13	FAZ-C13/1-SP	FAZ-C13/2	FAZ-C13/3
15	FAZ-C15/1-SP	FAZ-C15/2	FAZ-C15/3
16	FAZ-C16/1-SP	FAZ-C16/2	FAZ-C16/3
20	FAZ-C20/1-SP	FAZ-C20/2	FAZ-C20/3
25	FAZ-C25/1-SP	FAZ-C25/2	FAZ-C25/3
30	FAZ-C30/1-SP	FAZ-C30/2	FAZ-C30/3
32	FAZ-C32/1-SP	FAZ-C32/2	FAZ-C32/3
40	FAZ-C40/1-SP	FAZ-C40/2	FAZ-C40/3
50	FAZ-C50/1-SP	FAZ-C50/2	FAZ-C50/3
63	FAZ-C63/1-SP	FAZ-C63/2	FAZ-C63/3

Two-Pole



Three-Pole



Four-Pole



Single-Pole + Neutral



Three-Pole + Neutral



C Curve (5–10X I_n Current Rating)—Designed Inductive Loads, continued^①

Amperes	Four-Pole Catalog Number	Single-Pole + Neutral Catalog Number	Three-Pole + Neutral Catalog Number
0.5	FAZ-C0.5/4	FAZ-C0.5/1N	FAZ-C0.5/3N
1	FAZ-C1/4	FAZ-C1/1N	FAZ-C1/3N
1.6	FAZ-C1.6/4	FAZ-C1.6/1N	FAZ-C1.6/3N
2	FAZ-C2/4	FAZ-C2/1N	FAZ-C2/3N
3	FAZ-C3/4	FAZ-C3/1N	FAZ-C3/3N
4	FAZ-C4/4	FAZ-C4/1N	FAZ-C4/3N
5	FAZ-C5/4	FAZ-C5/1N	FAZ-C5/3N
6	FAZ-C6/4	FAZ-C6/1N	FAZ-C6/3N
7	FAZ-C7/4	FAZ-C7/1N	FAZ-C7/3N
8	FAZ-C8/4	FAZ-C8/1N	FAZ-C8/3N
10	FAZ-C10/4	FAZ-C10/1N	FAZ-C10/3N
13	FAZ-C13/4	FAZ-C13/1N	FAZ-C13/3N
15	FAZ-C15/4	FAZ-C15/1N	FAZ-C15/3N
16	FAZ-C16/4	FAZ-C16/1N	FAZ-C16/3N
20	FAZ-C20/4	FAZ-C20/1N	FAZ-C20/3N
25	FAZ-C25/4	FAZ-C25/1N	FAZ-C25/3N
30	FAZ-C30/4	FAZ-C30/1N	FAZ-C30/3N
32	FAZ-C32/4	FAZ-C32/1N	FAZ-C32/3N
40	FAZ-C40/4	FAZ-C40/1N	FAZ-C40/3N
50	FAZ-C50/4	FAZ-C50/1N	FAZ-C50/3N
63	FAZ-C63/4	FAZ-C63/1N	FAZ-C63/3N

Notes

- ① In North America, these switches are UL recognized and CSA Certified as supplementary protection devices. Per the intent of NEC (National Electrical Code), Article 240, and CEC (Canadian Electrical Code), Part 1 C22.1, supplementary breakers cannot be used as a substitute for the branch circuit protective device. They can be used to provide overcurrent protection within an appliance or other electrical equipment where branch circuit overcurrent protection is already provided, or is not required.
- ② Option for single packaging on single-pole B, C and D curves only; add suffix SP when ordering.

FAZ D curve (10–20X I_n current rating)

- Designed for highly inductive loads
- Response time of instantaneous trip: 10–20X I_n current rating
- UL recognized and CSA Certified as supplementary protectors
- For international and domestic use (conform to IEC 60947-2)
- UL file number 177451

Suitable for applications where high levels of inrush current are expected. Instantaneous trip is 10–20X rating of device (I_n). The high magnetic trip point prevents nuisance tripping in high inductive applications such as motors, transformers and power supplies.

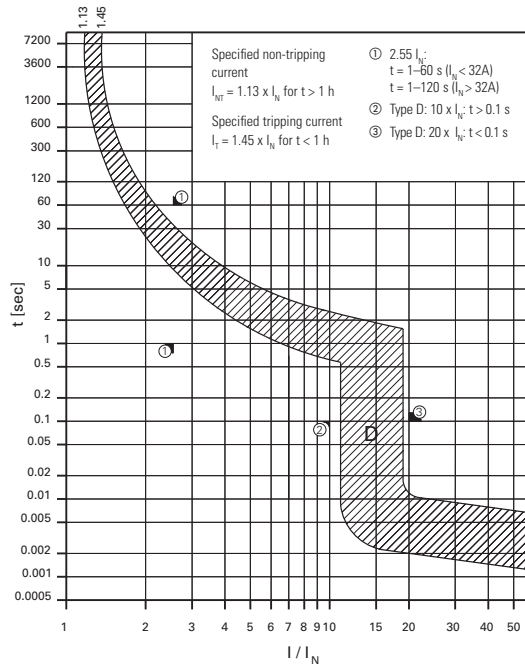

Single-Pole



Two-Pole



Three-Pole



D Curve (10–20X I_n Current Rating)— Designed for Inductive Loads ①

Amperes	Single-Pole ② Catalog Number	Two-Pole Catalog Number	Three-Pole Catalog Number
0.5	FAZ-D0.5/1-SP	FAZ-D0.5/2	FAZ-D0.5/3
1	FAZ-D1/1-SP	FAZ-D1/2	FAZ-D1/3
2	FAZ-D2/1-SP	FAZ-D2/2	FAZ-D2/3
3	FAZ-D3/1-SP	FAZ-D3/2	FAZ-D3/3
4	FAZ-D4/1-SP	FAZ-D4/2	FAZ-D4/3
5	FAZ-D5/1-SP	FAZ-D5/2	FAZ-D5/3
6	FAZ-D6/1-SP	FAZ-D6/2	FAZ-D6/3
7	FAZ-D7/1-SP	FAZ-D7/2	FAZ-D7/3
8	FAZ-D8/1-SP	FAZ-D8/2	FAZ-D8/3
10	FAZ-D10/1-SP	FAZ-D10/2	FAZ-D10/3
13	FAZ-D13/1-SP	FAZ-D13/2	FAZ-D13/3
15	FAZ-D15/1-SP	FAZ-D15/2	FAZ-D15/3
16	FAZ-D16/1-SP	FAZ-D16/2	FAZ-D16/3
20	FAZ-D20/1-SP	FAZ-D20/2	FAZ-D20/3
25	FAZ-D25/1-SP	FAZ-D25/2	FAZ-D25/3
30	FAZ-D30/1-SP	FAZ-D30/2	FAZ-D30/3
32	FAZ-D32/1-SP	FAZ-D32/2	FAZ-D32/3
40	FAZ-D40/1-SP	FAZ-D40/2	FAZ-D40/3
50 ③	FAZ-D50/1-SP	FAZ-D50/2	FAZ-D50/3
63 ③	FAZ-D63/1-SP	FAZ-D63/2	FAZ-D63/3

Four-Pole



Single-Pole + Neutral



Three-Pole + Neutral



D Curve (10–20X I_n Current Rating)— Designed for Inductive Loads, continued ①

Amperes	Four-Pole Catalog Number	Single-Pole + Neutral Catalog Number	Three-Pole + Neutral Catalog Number
0.5	FAZ-D0.5/4	FAZ-D0.5/1N	FAZ-D0.5/3N
1	FAZ-D1/4	FAZ-D1/1N	FAZ-D1/3N
2	FAZ-D2/4	FAZ-D2/1N	FAZ-D2/3N
3	FAZ-D3/4	FAZ-D3/1N	FAZ-D3/3N
4	FAZ-D4/4	FAZ-D4/1N	FAZ-D4/3N
5	FAZ-D5/4	FAZ-D5/1N	FAZ-D5/3N
6	FAZ-D6/4	FAZ-D6/1N	FAZ-D6/3N
7	FAZ-D7/4	FAZ-D7/1N	FAZ-D7/3N
8	FAZ-D8/4	FAZ-D8/1N	FAZ-D8/3N
10	FAZ-D10/4	FAZ-D10/1N	FAZ-D10/3N
13	FAZ-D13/4	FAZ-D13/1N	FAZ-D13/3N
15	FAZ-D15/4	FAZ-D15/1N	FAZ-D15/3N
16	FAZ-D16/4	FAZ-D16/1N	FAZ-D16/3N
20	FAZ-D20/4	FAZ-D20/1N	FAZ-D20/3N
25	FAZ-D25/4	FAZ-D25/1N	FAZ-D25/3N
30	FAZ-D30/4	FAZ-D30/1N	FAZ-D30/3N
32	FAZ-D32/4	FAZ-D32/1N	FAZ-D32/3N
40	FAZ-D40/4	FAZ-D40/1N	FAZ-D40/3N
50 ③	FAZ-D50/4	FAZ-D50/1N	FAZ-D50/3N
63 ③	FAZ-D63/4	FAZ-D63/1N	FAZ-D63/3N

Notes

- ① In North America, these switches are UL recognized and CSA Certified as supplementary protection devices. Per the intent of NEC (National Electrical Code), Article 240, and CEC (Canadian Electrical Code), Part 1 C22.1, supplementary breakers cannot be used as a substitute for the branch circuit protective device. They can be used to provide overcurrent protection within an appliance or other electrical equipment where branch circuit overcurrent protection is already provided, or is not required.
- ② Option for single packaging on single-pole B, C and D curves only; add suffix SP when ordering.
- ③ IEC 60947-2 only.

1.3

Miniature Circuit Breakers and Supplementary Protectors

UL 1077 DIN Rail Supplementary Protectors

1

FAZ K curve (8–12X I_n current rating)

- Designed for motors, transformers and upstream electronics
- Response time of instantaneous trip: 8–12X I_n current rating
- UL recognized and CSA Certified as supplementary protectors
- For international and domestic use (conform to IEC 60947-2)
- UL file number 177451

Suitable for applications where medium levels of inrush current are expected. Instantaneous trip is 8–12X rating of device (I_n). Applications include small transformers, lighting, pilot devices, control circuits and coils. Medium magnetic trip point.

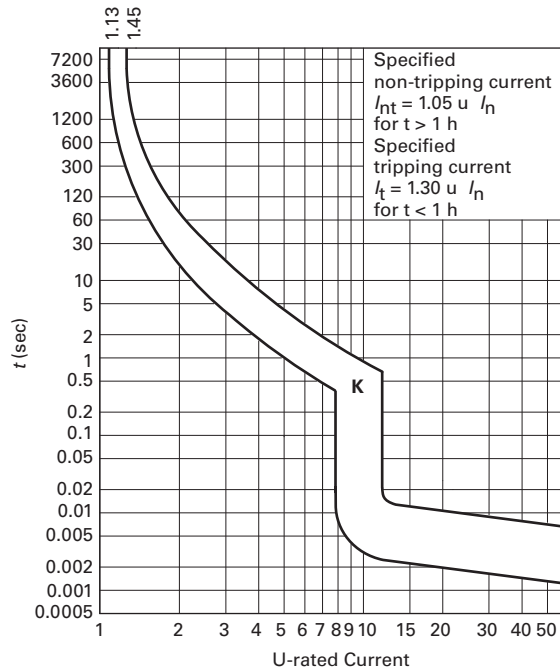

Single-Pole



Two-Pole



Three-Pole



K Curve (8–12X I_n Current Rating) — Designed for Inductive Loads ^{①②}

Amperes	Single-Pole ^③ Catalog Number	Two-Pole Catalog Number	Three-Pole Catalog Number
0.5	FAZ-K0.5/1	FAZ-K0.5/2	FAZ-K0.5/3
1	FAZ-K1/1	FAZ-K1/2	FAZ-K1/3
1.6	FAZ-K1.6/1	FAZ-K1.6/2	FAZ-K1.6/3
2	FAZ-K2/1	FAZ-K2/2	FAZ-K2/3
3	FAZ-K3/1	FAZ-K3/2	FAZ-K3/3
4	FAZ-K4/1	FAZ-K4/2	FAZ-K4/3
6	FAZ-K6/1	FAZ-K6/2	FAZ-K6/3
8	FAZ-K8/1	FAZ-K8/2	FAZ-K8/3
10	FAZ-K10/1	FAZ-K10/2	FAZ-K10/3
13	FAZ-K13/1	FAZ-K13/2	FAZ-K13/3
16	FAZ-K16/1	FAZ-K16/2	FAZ-K16/3
20	FAZ-K20/1	FAZ-K20/2	FAZ-K20/3
25	FAZ-K25/1	FAZ-K25/2	FAZ-K25/3
32	FAZ-K32/1	FAZ-K32/2	FAZ-K32/3
40	FAZ-K40/1	FAZ-K40/2	FAZ-K40/3
50	FAZ-K50/1	FAZ-K50/2	FAZ-K50/3
63	FAZ-K63/1	FAZ-K63/2	FAZ-K63/3

Four-Pole



Single-Pole + Neutral



Three-Pole + Neutral



K Curve (8–12X I_n Current Rating) — Designed for Inductive Loads, continued ^{①②}

Amperes	Four-Pole ^③ Catalog Number	Single-Pole + Neutral Catalog Number	Three-Pole + Neutral Catalog Number
0.5	FAZ-K0.5/4	FAZ-K0.5/1N	FAZ-K0.5/3N
1	FAZ-K1/4	FAZ-K1/1N	FAZ-K1/3N
1.6	FAZ-K1.6/4	FAZ-K1.6/1N	FAZ-K1.6/3N
2	FAZ-K2/4	FAZ-K2/1N	FAZ-K2/3N
3	FAZ-K3/4	FAZ-K3/1N	FAZ-K3/3N
4	FAZ-K4/4	FAZ-K4/1N	FAZ-K4/3N
6	FAZ-K6/4	FAZ-K6/1N	FAZ-K6/3N
8	FAZ-K8/4	FAZ-K8/1N	FAZ-K8/3N
10	FAZ-K10/4	FAZ-K10/1N	FAZ-K10/3N
13	FAZ-K13/4	FAZ-K13/1N	FAZ-K13/3N
16	FAZ-K16/4	FAZ-K16/1N	FAZ-K16/3N
20	FAZ-K20/4	FAZ-K20/1N	FAZ-K20/3N
25	FAZ-K25/4	FAZ-K25/1N	FAZ-K25/3N
32	FAZ-K32/4	FAZ-K32/1N	FAZ-K32/3N
40	FAZ-K40/4	FAZ-K40/1N	FAZ-K40/3N
50	FAZ-K50/4	FAZ-K50/1N	FAZ-K50/3N
63	FAZ-K63/4	FAZ-K63/1N	FAZ-K63/3N

Notes

- ① In North America, these switches are UL recognized and CSA Certified as supplementary protection devices. Per the intent of NEC (National Electrical Code), Article 240, and CEC (Canadian Electrical Code), Part 1 C22.1, supplementary breakers cannot be used as a substitute for the branch circuit protective device. They can be used to provide overcurrent protection within an appliance or other electrical equipment where branch circuit overcurrent protection is already provided, or is not required.
- ② These breakers are available by special order and may result in additional delivery time.
- ③ Two-piece box order, quantities of 2.

FAZ S curve (13–17X I_n current rating)

- Designed for control circuits with high inrush
- Response time of instantaneous trip: 13–17X I_n current rating
- UL recognized and CSA Certified as supplementary protectors
- For international and domestic use (conform to IEC 60947-2)
- UL file number 177451

Suitable for applications where high levels of inrush current are expected. Instantaneous trip is 13–17X rating of device (I_n). The high magnetic trip point prevents nuisance tripping in high inductive applications such as motors, transformers and power supplies.

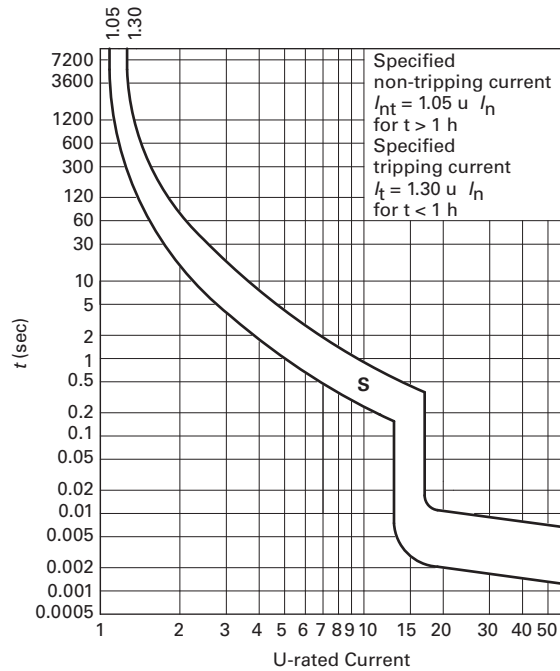

Single-Pole



Two-Pole



S Curve (13–17X I_n Current Rating)— Designed for Inductive Loads ①②

Amperes	Single-Pole ③	Two-Pole
	Catalog Number	Catalog Number
1	FAZ-S1/1	FAZ-S1/2
2	FAZ-S2/1	FAZ-S2/2
3	FAZ-S3/1	FAZ-S3/2
4	FAZ-S4/1	FAZ-S4/2
6	FAZ-S6/1	FAZ-S6/2
10	FAZ-S10/1	FAZ-S10/2
16	FAZ-S16/1	FAZ-S16/2
20	FAZ-S20/1	FAZ-S20/2
25	FAZ-S25/1	FAZ-S25/2
32	FAZ-S32/1	FAZ-S32/2
40	FAZ-S40/1	FAZ-S40/2

Notes

- ① In North America, these switches are UL recognized and CSA Certified as supplementary protection devices. Per the intent of NEC (National Electrical Code), Article 240, and CEC (Canadian Electrical Code), Part 1 C22.1, supplementary breakers cannot be used as a substitute for the branch circuit protective device. They can be used to provide overcurrent protection within an appliance or other electrical equipment where branch circuit overcurrent protection is already provided, or is not required.
- ② These breakers are available by special order and may result in additional delivery time.
- ③ Two-piece box order, quantities of 2.

1.3

Miniature Circuit Breakers and Supplementary Protectors

UL 1077 DIN Rail Supplementary Protectors

1

FAZ Z curve (2–3X I_n current rating)

- Designed for protection of electronic devices
- Response time of instantaneous trip: 2–3X I_n current rating
- UL recognized and CSA Certified as supplementary protectors
- For international and domestic use (conform to IEC 60947-2)

Suitable for applications where low levels of inrush current are expected. Instantaneous trip is 2–3X rating of device (I_n). Applications include small transformers, lighting, pilot devices, control circuits and coils. Medium magnetic trip point.

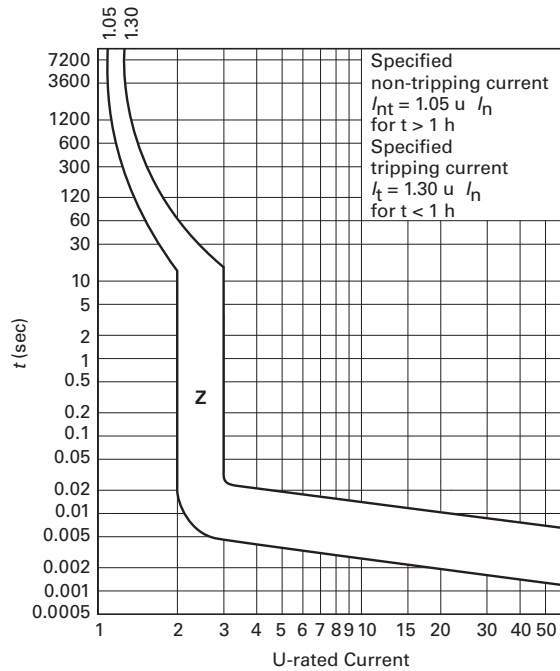

Single-Pole



Z Curve (2–3X I_n Current Rating)—Designed for Inductive Loads ①②

Amperes	Single-Pole ③ Catalog Number	Two-Pole Catalog Number
0.5	FAZ-Z0.5/1	FAZ-Z0.5/2
1	FAZ-Z1/1	FAZ-Z1/2
1.6	FAZ-Z1.6/1	FAZ-Z1.6/2
2	FAZ-Z2/1	FAZ-Z2/2
3	FAZ-Z3/1	FAZ-Z3/2
4	FAZ-Z4/1	FAZ-Z4/2
6	FAZ-Z6/1	FAZ-Z6/2
8	FAZ-Z8/1	FAZ-Z8/2
10	FAZ-Z10/1	FAZ-Z10/2
13	FAZ-Z13/1	FAZ-Z13/2
16	FAZ-Z16/1	FAZ-Z16/2
20	FAZ-Z20/1	FAZ-Z20/2
25	FAZ-Z25/1	FAZ-Z25/2
32	FAZ-Z32/1	FAZ-Z32/2
40	FAZ-Z40/1	FAZ-Z40/2
50	FAZ-Z50/1	FAZ-Z50/2
63	FAZ-Z63/1	FAZ-Z63/2

Two-Pole



Three-Pole



Z Curve (2–3X I_n Current Rating)—Designed for Inductive Loads, continued ①②

Amperes	Three-Pole Catalog Number	Four-Pole Catalog Number
0.5	FAZ-Z0.5/3	FAZ-Z0.5/4
1	FAZ-Z1/3	FAZ-Z1/4
1.6	FAZ-Z1.6/3	FAZ-Z1.6/4
2	FAZ-Z2/3	FAZ-Z2/4
3	FAZ-Z3/3	FAZ-Z3/4
4	FAZ-Z4/3	FAZ-Z4/4
6	FAZ-Z6/3	FAZ-Z6/4
8	FAZ-Z8/3	FAZ-Z8/4
10	FAZ-Z10/3	FAZ-Z10/4
13	FAZ-Z13/3	FAZ-Z13/4
16	FAZ-Z16/3	FAZ-Z16/4
20	FAZ-Z20/3	FAZ-Z20/4
25	FAZ-Z25/3	FAZ-Z25/4
32	FAZ-Z32/3	FAZ-Z32/4
40	FAZ-Z40/3	FAZ-Z40/4
50	FAZ-Z50/3	FAZ-Z50/4
63	FAZ-Z63/3	FAZ-Z63/4

Four-Pole







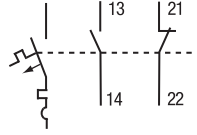

Notes

- ① In North America, these switches are UL recognized and CSA Certified as supplementary protection devices. Per the intent of NEC (National Electrical Code), Article 240, and CEC (Canadian Electrical Code), Part 1 C22.1, supplementary breakers cannot be used as a substitute for the branch circuit protective device. They can be used to provide overcurrent protection within an appliance or other electrical equipment where branch circuit overcurrent protection is already provided, or is not required.
- ② These breakers are available by special order and may result in additional delivery time.
- ③ Two-piece box order, quantities of 2.

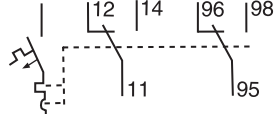
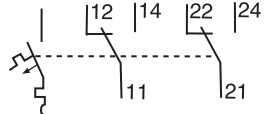
Accessories

FAZ Auxiliary Contacts and Voltage Trips

	Circuit Diagram	Description	Rated Operational Voltage	Catalog Number
Standard Auxiliary Contacts				
		<ul style="list-style-type: none"> 1NO/1NC Installs on left side of FAZ or shunt trip Max. one per FAZ (1077) device Switches when FAZ is tripped electrically or manually 	230 Vac	FAZ-XHIN11
		<ul style="list-style-type: none"> 1 changeover contact Installs on left side of FAZ or shunt trip Max. one per FAZ (1077) device Switches when FAZ is tripped electrically or manually 	230 Vac	FAZ-XHINW1
Auxiliary/Trip Indicating Contact				
	 <p>Two-pole auxiliary mode</p>  <p>Trip indicating mode</p>	<ul style="list-style-type: none"> Small selector screw changes mode Two Form C (changeover) contacts Installs on left side of FAZ or shunt trip Auxiliary contacts switch when FAZ is tripped electrically or manually Trip indicating contact switches only when FAZ is tripped electrically 	230 Vac	FAZ-XAM002
Undervoltage Trip				
		<ul style="list-style-type: none"> Prevents FAZ from operating unless voltage is present Installs on left side of FAZ Includes test button 	115 Vac 230 Vac 400 Vac	FAZ-XUA(115VAC) FAZ-XUA(230VAC) FAZ-XUA(400VAC)
Shunt Trip				
		<ul style="list-style-type: none"> Allows remote trip of FAZ Installs on left side of FAZ 	12–110 Vac 12–60 Vdc 110–415 Vac 110–230 Vdc	FAZ-XAA-C-12-110VAC FAZ-XAA-C-110-415VAC

Allowable Combinations of Accessories

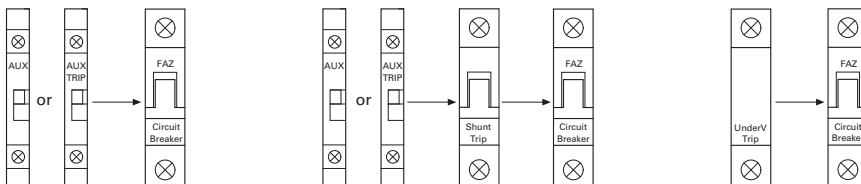

1.3

Miniature Circuit Breakers and Supplementary Protectors

UL 1077 DIN Rail Supplementary Protectors

1

Busbar System

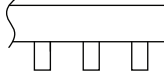
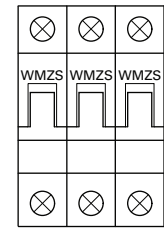
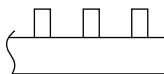
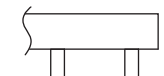
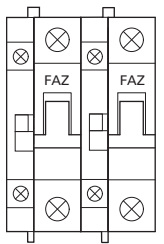
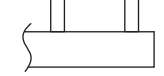
Description	Rated Operational Current	Number of Poles per Device	Number of Terminals	Catalog Number ^①
Without Auxiliary Contacts				
For connecting FAZ supplementary protectors without auxiliary contacts. May be fed from line or load side.	80A	1	57	BB-UL-18/1P-1M/57
		2	56	BB-UL-18/2P-2M/56
		3	57	BB-UL-18/3P-3M/57
	100A	1	57	BB-UL-25/1P-1M/57
		2	56	BB-UL-25/2P-2M/56
		3	57	BB-UL-25/3P-3M/57
Auxiliary/Trip Indicating Contacts				
For connecting FAZ supplementary protectors with auxiliary contacts. May be fed from line or load side.	80A	1	37	BB-UL-18/1P-1,5M/37
		2	46	BB-UL-18/2P+AS-2,5M/46
		3	48	BB-UL-18/3P+AS-3,5M/48
	100A	1	37	BB-UL-25/1P-1,5M/37
		2	46	BB-UL-25/2P+AS-2,5M/46
		3	48	BB-UL-25/3P+AS-3,5M/48

Note

① Bus may be center fed for high current capacity.

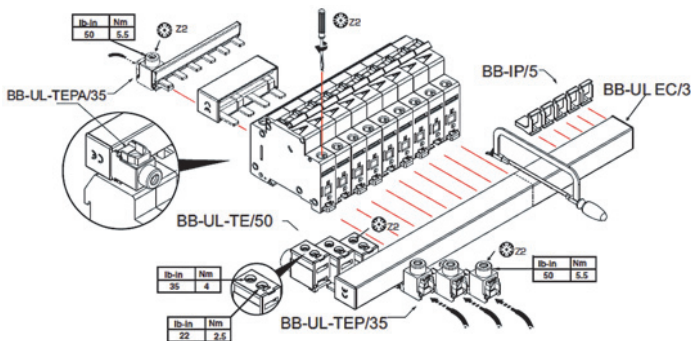

Incoming Terminal

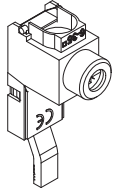

Pin Type Incoming Supply Terminals

Description	Catalog Number
<ul style="list-style-type: none"> Accommodates conductors from 6–35 mm²/#10–2 AWG 4–5.5 Nm/35–50 lb-in Two- and three-pole 	BB-UL-TEP/35

Incoming Terminal

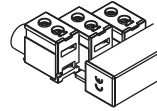

Bus Incoming Supply Terminals

Description	Catalog Number
<ul style="list-style-type: none"> 50 mm² #14–1 AWG 75 Deg wire 115 A/Y, 480V UL 160 A/Y 690V IEC 	BB-UL-TE/50

Incoming Terminal

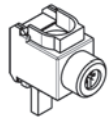

Pin Type Incoming Supply Terminals—Single-Phase Only

Description	Catalog Number
<ul style="list-style-type: none"> Accommodates conductors from 6–35 mm²/#10–2 AWG 4–5.5 Nm/35–50 lb-in 	BB-UL-TEPA/35

Fork Connector

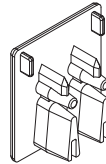

Busbar End Cap

Description	Poles	Catalog Number
<ul style="list-style-type: none"> Install after cutting busbar 	2 and 3	BB-UL-EC/3
<ul style="list-style-type: none"> Protects end of busbar 	1	BB-UL-EC/1

Busbar Terminal Cover

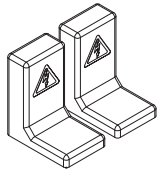

Protective Accessories

Description	Catalog Number
For covering unused terminals	BB-IP/5
<ul style="list-style-type: none"> Prevents reactivation of the device during maintenance Holds one padlock 	IS/SPE-1TE

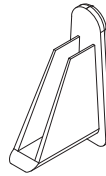

Padlock Hasp

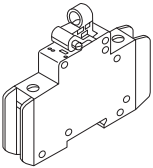

1

Technical Data and Specifications

Trip Curves Chart

Eaton FAZ supplementary protectors are available with six different tripping characteristics, including Type B, C, D, K, S and Z. Definitions for each trip curve are contained on the ordering pages and can be used to determine the optimal characteristic for your application. For example, low-level short-circuit faults in control wiring, such as PLCs, are best protected by devices with Type B trip characteristics (3–5X continuous rating of the device I_n).

Even though not required by NEC or CEC for supplementary protectors, Eaton's FAZ devices are current limiting, which means that they interrupt fault currents within one half cycle. Current limiting devices offer superior protection by reducing peak let-through current and energy.

Tripping Characteristics

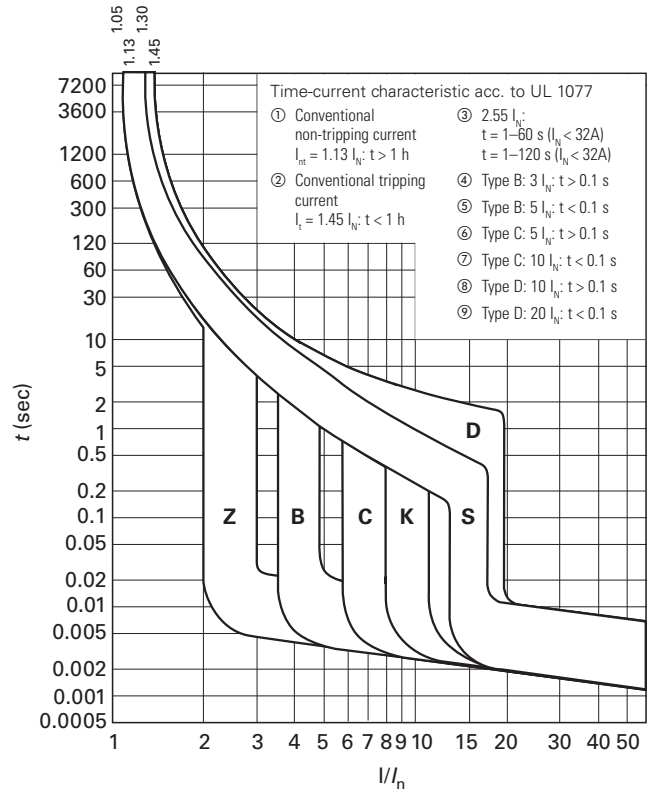

FAZ Miniature Circuit Breakers Technical Data

Description	B Curve	C Curve	D Curve
Electrical			
Approvals	UR (UL 1077), CSA (CSA 22.2 No. 235), CE		
Standards	IEC/EN 60947-2		
Short-circuit trip response	3–5 I_n	5–10 I_n	10–20 I_n
Supplementary Protectors—UL/CSA			
Current range	1–63A	0.5–63A	0.5–40A
Maximum voltage ratings—UL/CSA			
Single-pole, single-pole + neutral	277 Vac 48 Vdc	277 Vac 48 Vdc	277 Vac 48 Vdc
Two-, three-pole, four-pole and three-pole + neutral Two poles in series	480Y/277 Vac 96 Vdc	480Y/277 Vac 96 Vdc	480Y/277 Vac 96 Vdc
Thermal tripping characteristics			
Single-pole	1.35 x I_n @ 40°C	1.35 x I_n @ 40°C	1.35 x I_n @ 40°C
Multi-pole	1.45 x I_n @ 40°C	1.45 x I_n @ 40°C	1.45 x I_n @ 40°C
Short-circuit ratings (at max. voltage)			
Single-pole	10 kA (5 kA for 40–63A device)	10 kA (5 kA for 40–63A device)	5 kA
Two-, three-pole	10 kA (5 kA for 40–63A device)	10 kA (5 kA for 40–63A device)	5 kA
Single-pole	10 kA @ 48 Vdc	10 kA @ 48 Vdc	10 kA @ 48 Vdc
Two poles in series	10 kA @ 96 Vdc	10 kA @ 96 Vdc	10 kA @ 96 Vdc
Miniature Circuit Breaker—IEC			
Current range	1–63A	0.5–63A	0.5–63A
Maximum voltage ratings—IEC 68898-1			
Single-pole	230 Vac	230 Vac	230 Vac
Two-, three-pole	230/400 Vac	230/400 Vac	230/400 Vac
Maximum voltage ratings—IEC 60947-2			
Single-pole	240 Vac 48 Vdc	240 Vac 48 Vdc	240 Vac 48 Vdc
Two-, three-pole	240/415 Vac	240/415 Vac	240/415 Vac
Two poles in series	96 Vdc	96 Vdc	96 Vdc
Thermal tripping characteristics			
Single-pole	> 1 hour @ 1.05 x I_n	> 1 hour @ 1.05 x I_n	> 1 hour @ 1.05 x I_n
Multi-pole	< 1 hour @ 1.3 x I_n	< 1 hour @ 1.3 x I_n	< 1 hour @ 1.3 x I_n
Interrupt ratings (at max. voltage)			
IEC 60947-2	15 kA	15 kA	15 kA (10 kA for 50 and 63A)
IEC 60898	10 kA	10 kA	10 kA (50 and 63A not available)
Operational switching capacity	7.5 kA	7.5 kA	7.5 kA
Max. backup fuse [gL/gG]	125A	125A	125A
Rated impulse withstand— U_{imp}	4000 Vac	4000 Vac	4000 Vac
Rated insulation voltage— U_i	440 Vac	440 Vac	440 Vac
Environmental/General			
Selectivity class	3	3	3
Lifespan (operations)	> 10,000 (1 operation = ON/OFF)	> 10,000 (1 operation = ON/OFF)	> 10,000 (1 operation = ON/OFF)
Shock (IEC 68-2-22)	10g–120 ms	10g–120 ms	10g–120 ms
Operating temperature range	–40 to +167°F (–40 to +75°C)	–40 to +167°F (–40 to +75°C)	–40 to +167°F (–40 to +75°C)
Shipment and short-term storage	–40 to +185°F (–40 to +85°C)	–40 to +185°F (–40 to +85°C)	–40 to +185°F (–40 to +85°C)
Housing material	Nylon	Nylon	Nylon
Mechanical			
Standard front dimension			
Device height	80 mm	80 mm	80 mm
Terminal protection	Finger and back-of-hand proof to IEC 536	Finger and back-of-hand proof to IEC 536	Finger and back-of-hand proof to IEC 536
Mounting width per pole	17.5 mm	17.5 mm	17.5 mm
Mounting	IEC/EN 60715 top-hat rail	IEC/EN 60715 top-hat rail	IEC/EN 60715 top-hat rail
Degree of protection	IP20	IP20	IP20
Terminals top and bottom	Twin-purpose terminals	Twin-purpose terminals	Twin-purpose terminals
Supply connection	Line or load side	Line or load side	Line or load side
Terminal capacity [mm ²]	1 x 25 (AWG 4–18)/2 x 10 (AWG 8–18)	1 x 25 (AWG 4–18)/2 x 10 (AWG 8–18)	1 x 25 (AWG 4–18)/2 x 10 (AWG 8–18)
Torque	2.4 Nm	2.4 Nm	2.4 Nm
Imperial torque	21 lb-in (AWG 18–12), 25 lb-in (AWG 10–8), 36 lb-in (AWG 6–4)	21 lb-in (AWG 18–12), 25 lb-in (AWG 10–8), 36 lb-in (AWG 6–4)	21 lb-in (AWG 18–12), 25 lb-in (AWG 10–8), 36 lb-in (AWG 6–4)
Thickness of busbar material	0.8–2 mm	0.8–2 mm	0.8–2 mm
Mounting position	As required	As required	As required

1.3

Miniature Circuit Breakers and Supplementary Protectors

UL 1077 DIN Rail Supplementary Protectors

1

FAZ Miniature Circuit Breakers Technical Data, continued

Description	B Curve	C Curve	D Curve
Electrical			
Approvals	UR (UL 1077), CSA (CSA 22.2 No. 235), CE		
Standards	IEC/EN 60947-2, E177451, 204453		
Short-circuit trip response	8–12 I_n	13–17 I_n	2–3 I_n
Supplementary Protectors—UL/CSA			
Current range	0.5–63A	0.5–40A	1–63A
Maximum voltage ratings—UL/CSA			
Single-pole, single-pole + neutral	277 Vac 48 Vdc	277 Vac 48 Vdc	277 Vac 48 Vdc
Two-, three-, four-pole and three-pole + neutral	480Y/277 Vac	480Y/277 Vac	480Y/277 Vac
Two poles in series	96 Vdc	96 Vdc	96 Vdc
Thermal tripping characteristics			
Single-pole	1.35 x I_n @ 40°C	1.35 x I_n @ 40°C	1.35 x I_n @ 40°C
Multi-pole	1.45 x I_n @ 40°C	1.45 x I_n @ 40°C	1.45 x I_n @ 40°C
Short-circuit ratings (at max. voltage)			
Single-pole	5 kA @ 277 Vac	5 kA @ 277 Vac	5 kA @ 277 Vac
Single-pole + neutral	5 kA @ 277 Vac	5 kA @ 277 Vac	5 kA @ 277 Vac
Two-, three-, four-pole	5 kA @ 480Y/277 Vac	5 kA @ 480Y/277 Vac	5 kA @ 480Y/277 Vac
Two poles in series	—	—	—
Miniature Circuit Breaker—IEC			
Current range	0.5–63A	0.5–40A	1–63A
Maximum voltage ratings—IEC 60947-2			
Single-pole, single-pole + neutral	240 Vac	240 Vac	240 Vac
Two-, three-, four-pole, three-pole + neutral	240/415 Vac	240/415 Vac	240/415 Vac
Thermal tripping characteristics			
Single-pole	> 1 Hour @ 1.05 x I_n	> 1 Hour @ 1.05 x I_n	> 1 Hour @ 1.05 x I_n
Multi-pole	< 1 Hour @ 1.3 x I_n	< 1 Hour @ 1.3 x I_n	< 1 Hour @ 1.3 x I_n
Interrupt ratings (at max. voltage)			
IEC 60947-2	15 kA	10 kA	10 kA
Operational switching capacity	7.5 kA	7.5 kA	7.5 kA
Max. backup fuse [gL/gG]	125A	125A	125A
Rated impulse withstand— U_{imp}	4000 Vac	4000 Vac	4000 Vac
Rated insulation voltage— U_i	440 Vac	440 Vac	440 Vac
Environmental/General			
Selectivity class	3	3	3
Lifespan (operations)	> 10,000 (1 operation = ON/OFF)	> 10,000 (1 operation = ON/OFF)	> 10,000 (1 operation = ON/OFF)
Shock (IEC 68-2-22)	10g–120 ms	10g–120 ms	10g–120 ms
Operating temperature range	–40 to +167°F (–40 to +75°C)	–40 to +167°F (–40 to +75°C)	–40 to +167°F (–40 to +75°C)
Shipment and short-term storage	–40 to +185°F (–40 to +85°C)	–40 to +185°F (–40 to +85°C)	–40 to +185°F (–40 to +85°C)
Housing material	Nylon	Nylon	Nylon
Mechanical			
Standard front dimension			
Device height	80 mm	80 mm	80 mm
Terminal protection	Finger and back-of-hand proof to IEC 536	Finger and back-of-hand proof to IEC 536	Finger and back-of-hand proof to IEC 536
Mounting width per pole	17.7 mm	17.7 mm	17.7 mm
Mounting	IEC/EN 60715 top-hat rail	IEC/EN 60715 top-hat rail	IEC/EN 60715 top-hat rail
Degree of protection	IP20	IP20	IP20
Terminals top and bottom	Twin-purpose terminals	Twin-purpose terminals	Twin-purpose terminals
Supply connection	Line or load side	Line or load side	Line or load side
Terminal capacity [mm ²]	1 x 25 (AWG 4–18) / 2 x 10 (AWG 8–18)	1 x 25 (AWG 4–18) / 2 x 10 (AWG 8–18)	1 x 25 (AWG 4–18) / 2 x 10 (AWG 8–18)
Torque	2.4 Nm	2.4 Nm	2.4 Nm
Imperial torque	21 lb-in (AWG 18–12), 25 lb-in (AWG 10–8), 36 lb-in (AWG 6–4)	21 lb-in (AWG 18–12), 25 lb-in (AWG 10–8), 36 lb-in (AWG 6–4)	21 lb-in (AWG 18–12), 25 lb-in (AWG 10–8), 36 lb-in (AWG 6–4)
Thickness of busbar material	0.8–2 mm	0.8–2 mm	0.8–2 mm
Mounting position	As required	As required	As required

Let-Through Energy I^2t

Characteristic B and C

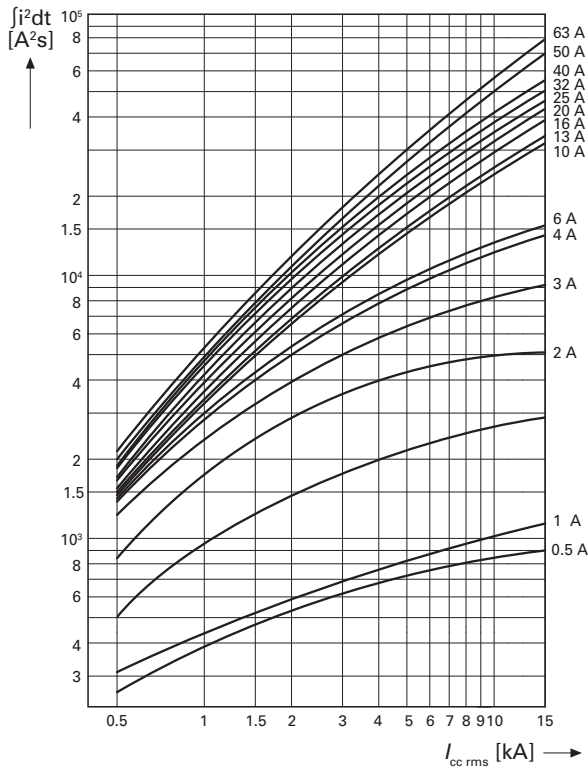

Let-Through Energy I_D

Characteristic B and C

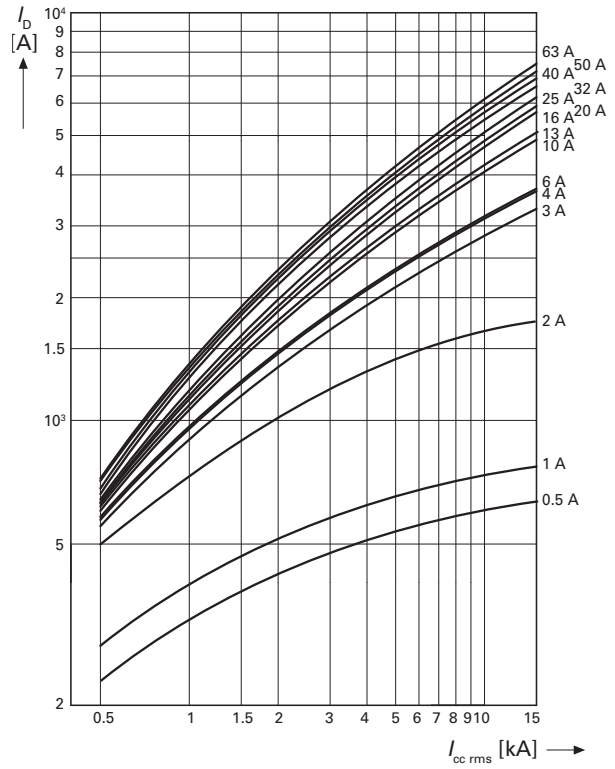

Characteristic D

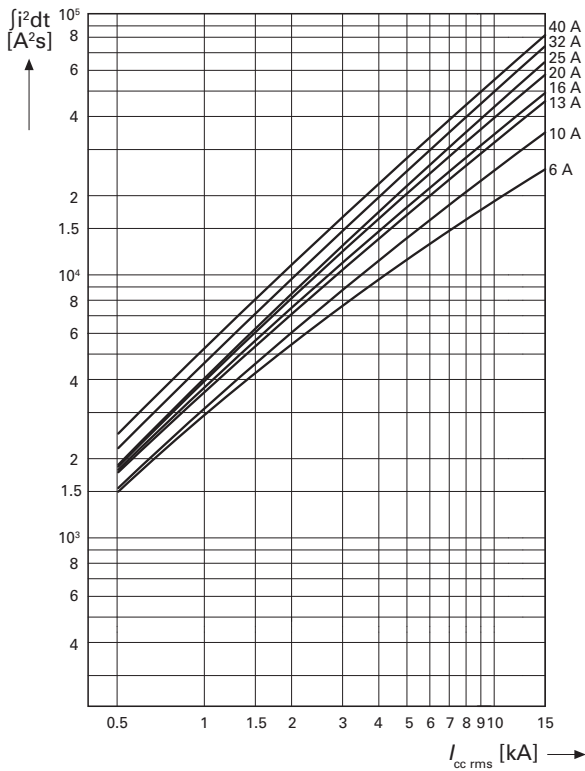

Characteristic D

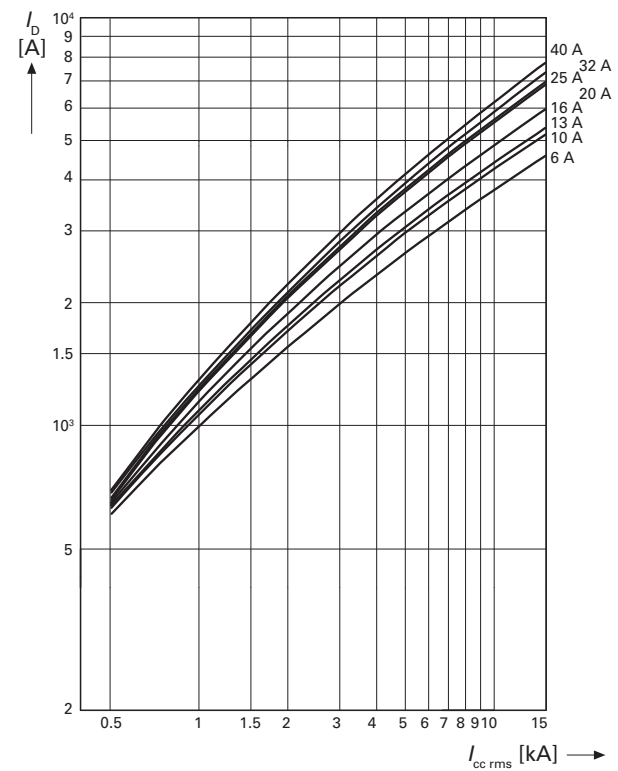

1.3

Miniature Circuit Breakers and Supplementary Protectors

UL 1077 DIN Rail Supplementary Protectors

1

Let-Through Energy I^2t

Characteristic K

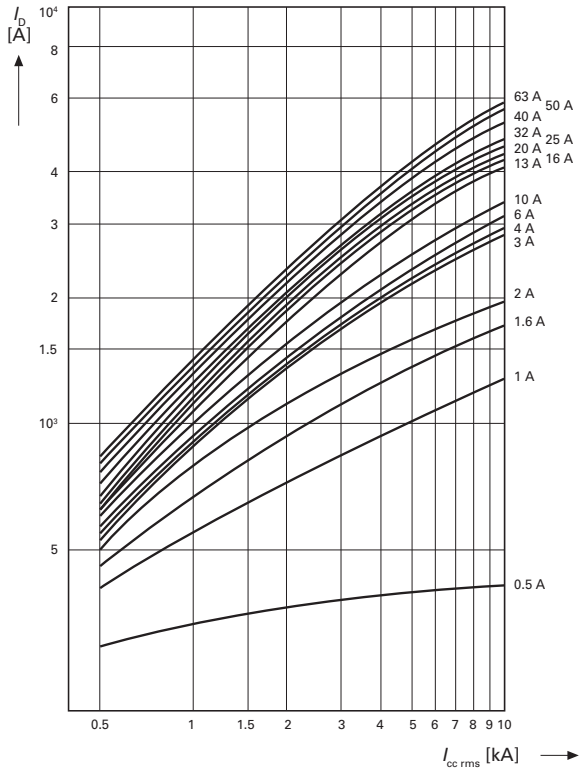

Characteristic S

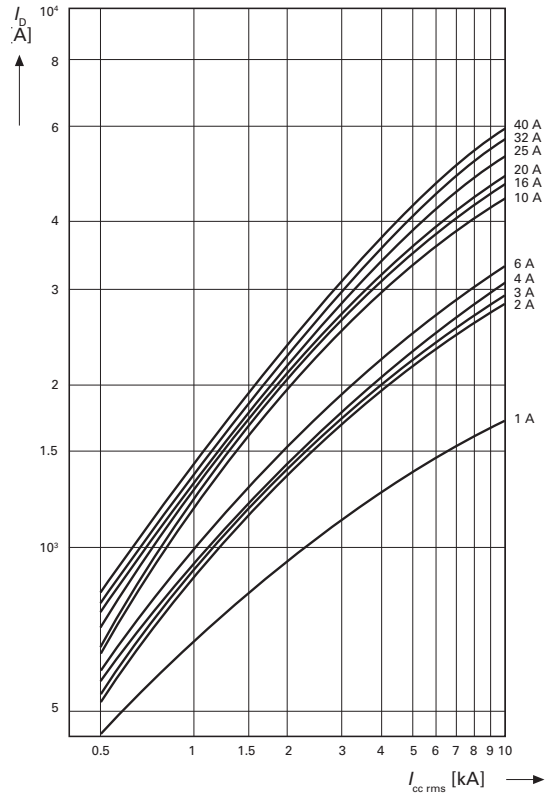

Characteristic Z

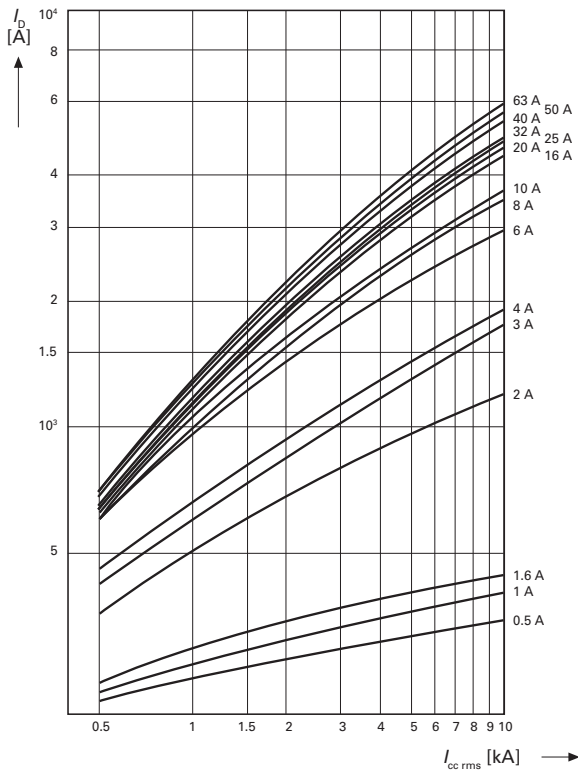

Influence of the Ambient Temperature on the Thermal Tripping Behavior

Corrected values of the rated current dependent on the ambient temperature

I_n (A)	Ambient Temperature T																
	-40°C	-30°C	-20°C	-10°C	0°C	10°C	20°C	30°C	35°C	40°C	45°C	50°C	55°C	60°C	65°C	70°C	75°C
0.16	0.20	0.20	0.19	0.19	0.18	0.17	0.17	0.16	0.16	0.15	0.15	0.15	0.14	0.14	0.14	0.14	0.13
0.25	0.32	0.31	0.30	0.29	0.28	0.27	0.26	0.25	0.25	0.24	0.24	0.23	0.23	0.22	0.22	0.21	0.21
0.50	0.64	0.62	0.60	0.58	0.56	0.54	0.52	0.50	0.49	0.48	0.47	0.46	0.45	0.44	0.43	0.42	0.41
0.75	0.96	0.93	0.90	0.87	0.84	0.81	0.78	0.75	0.74	0.73	0.71	0.69	0.68	0.66	0.65	0.64	0.62
1.00	1.30	1.20	1.20	1.20	1.10	1.10	1.00	1.00	0.99	0.97	0.95	0.93	0.90	0.89	0.87	0.85	0.83
1.50	1.90	1.90	1.80	1.70	1.70	1.60	1.60	1.50	1.50	1.50	1.40	1.40	1.40	1.30	1.30	1.30	1.20
1.60	2.00	2.00	1.90	1.90	1.80	1.70	1.70	1.60	1.60	1.50	1.50	1.50	1.40	1.40	1.40	1.40	1.30
2.00	2.60	2.50	2.40	2.30	2.20	2.20	2.10	2.00	2.00	1.90	1.90	1.90	1.80	1.80	1.70	1.70	1.70
2.50	3.20	3.10	3.00	2.90	2.80	2.70	2.60	2.50	2.50	2.40	2.40	2.30	2.30	2.20	2.20	2.10	2.10
3.00	3.80	3.70	3.60	3.50	3.40	3.30	3.10	3.00	3.00	2.90	2.80	2.80	2.70	2.70	2.60	2.50	2.50
3.50	4.50	4.40	4.20	4.10	3.90	3.80	3.70	3.50	3.40	3.40	3.30	3.20	3.20	3.10	3.00	3.00	2.90
4.00	5.10	5.00	4.80	4.70	4.50	4.30	4.20	4.00	3.90	3.90	3.80	3.70	3.60	3.50	3.50	3.40	3.30
5.00	6.40	6.20	6.00	5.80	5.60	5.40	5.20	5.00	4.90	4.80	4.70	4.60	4.50	4.40	4.30	4.20	4.10
6.00	7.70	7.50	7.20	7.00	6.70	6.50	6.30	6.00	5.90	5.80	5.70	5.60	5.40	5.30	5.20	5.10	5.00
7.00	9.00	8.70	8.40	8.20	7.80	7.60	7.40	7.00	6.90	6.80	6.70	6.50	6.30	6.20	6.10	6.00	5.80
8.00	10.20	9.90	9.60	9.30	9.00	8.70	8.40	8.00	7.90	7.70	7.60	7.40	7.20	7.10	6.90	6.80	6.60
10.00	13.00	12.00	12.00	12.00	11.00	11.00	10.00	10.00	9.90	9.70	9.50	9.30	9.00	8.90	8.70	8.50	8.30
12.00	15.00	15.00	14.00	14.00	13.00	13.00	13.00	12.00	12.00	12.00	11.00	11.00	11.00	11.00	10.00	10.00	10.00
13.00	17.00	16.00	16.00	15.00	15.00	14.00	14.00	13.00	13.00	13.00	12.00	12.00	12.00	12.00	11.00	11.00	11.00
15.00	19.00	19.00	18.00	17.00	17.00	16.00	16.00	15.00	15.00	15.00	14.00	14.00	14.00	13.00	13.00	13.00	12.00
16.00	20.00	20.00	19.00	19.00	18.00	17.00	17.00	16.00	16.00	15.00	15.00	15.00	14.00	14.00	14.00	14.00	13.00
20.00	26.00	25.00	24.00	23.00	22.00	22.00	21.00	20.00	20.00	19.00	19.00	19.00	18.00	18.00	17.00	17.00	17.00
25.00	32.00	31.00	30.00	29.00	28.00	27.00	26.00	25.00	25.00	24.00	24.00	23.00	23.00	22.00	22.00	21.00	21.00
32.00	41.00	40.00	38.00	37.00	36.00	35.00	33.00	32.00	32.00	31.00	30.00	30.00	29.00	28.00	28.00	27.00	26.00
35.00	45.00	43.00	41.00	41.00	38.00	38.00	36.00	35.00	35.00	34.00	33.00	32.00	32.00	32.00	30.00	29.00	29.00
40.00	51.00	50.00	48.00	47.00	45.00	43.00	42.00	40.00	39.00	39.00	38.00	37.00	36.00	35.00	35.00	34.00	33.00
50.00	64.00	62.00	60.00	58.00	56.00	54.00	52.00	50.00	49.00	48.00	47.00	46.00	45.00	44.00	43.00	42.00	41.00
63.00	81.00	78.00	76.00	73.00	71.00	68.00	66.00	63.00	62.00	61.00	60.00	58.00	57.00	56.00	55.00	53.00	52.00

Influence of the Mains Frequency

Influence of the mains frequency on the tripping behavior I_{MA} of the instantaneous release

$I_{MA}(f)/I_{MA}(50\text{ Hz})$ [%]	Mains Frequency f [Hz]						
	16 2/3	50	60	100	200	300	400
	91	100	101	106	115	134	141

Load Carrying Capacity of Adjoining Miniature Circuit Breakers

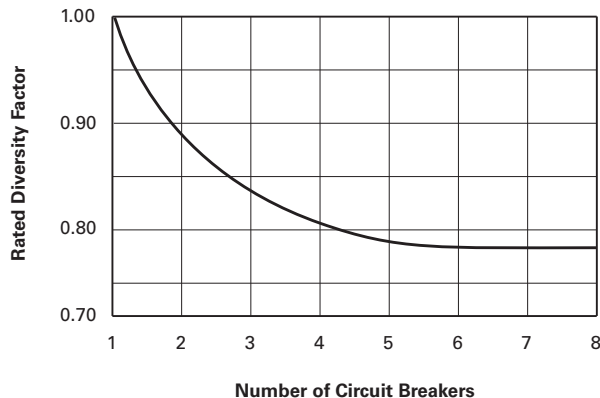

1.3

Miniature Circuit Breakers and Supplementary Protectors

UL 1077 DIN Rail Supplementary Protectors

1

Accessories Technical Data

Description	FAZ-XHIN FAZ-XAM002	FAZ-XAA-C	FAZ-XUA
Electrical			
Contact function	1A + 1B 2 C/O	—	—
Rated operational voltage U_n	250 Vac	—	115 Vac 230 Vac 400 Vac
Voltage range	—	12–110 Vac 12–60 Vdc	—
Voltage range	—	110–415 Vac 110–230 Vdc	—
Closing threshold [$\times U_n$]	—	—	0.8
Tripping threshold [$\times U_n$]	—	—	0.5
Rated frequency f	50/60 Hz	50/60 Hz	50/60 Hz
General use (UL/CSA) AC—230/240 Vac DC—110/120 Vdc	2/2A 0.5/0.5A	—	—
Pilot duty	A600/Q600	—	—
Conventional free air thermal current I_{th}	4A	—	—
Rated operational current AC-13 I_b AC-15 I_b DC-13 I_b	3A (250 Vac) 2A (250 Vac) 0.5A (110 Vdc)	—	—
Rated insulation voltage U_i	250 Vac	—	—
Minimum operating voltage per contract U_{min}	5 Vdc	—	—
Rated impulse withstand voltage (1.2/50 μ) U_{imp}	2.5 kV	—	—
Rated conditional short-circuit current with 6A backup fuse I_{SC}	1 kA	—	—
Max. admissible backup fuse	4A gL	—	—
Mechanical			
Standard front dimension	45 mm	45 mm	45 mm
Device height	80 mm	80 mm	80 mm
Mounting width	8.8 mm	17.6 mm	17.8 mm
Mounting	On MCB	IEC/EN 60715 top-hat rail	IEC/EN 60715 top-hat rail
Degree of protection enclosed	IP40	IP40	IP40
Terminal protection	Protection against electric shock to IEC 536	Protection against electric shock to IEC 536	Protection against electric shock to IEC 536
Terminals	Lift terminals	Twin-purpose terminals	Twin-purpose terminals
Terminal capacity Solid Flexible	0.5–2.5 mm ² 0.5–2.5 mm ²	1–2.5 mm ² 1–2.5 mm ²	2 x (1–2.5) mm ² 2 x (1–2.5) mm ²
Tightening torque of terminal screws	0.8–1.0 Nm (7–9 lb-in)	2.4 Nm (21 lb-in)	0.8 Nm (7 lb-in)

Dimensions

Approximate Dimensions in Inches (mm)

Miniature Circuit Breakers

FAZ

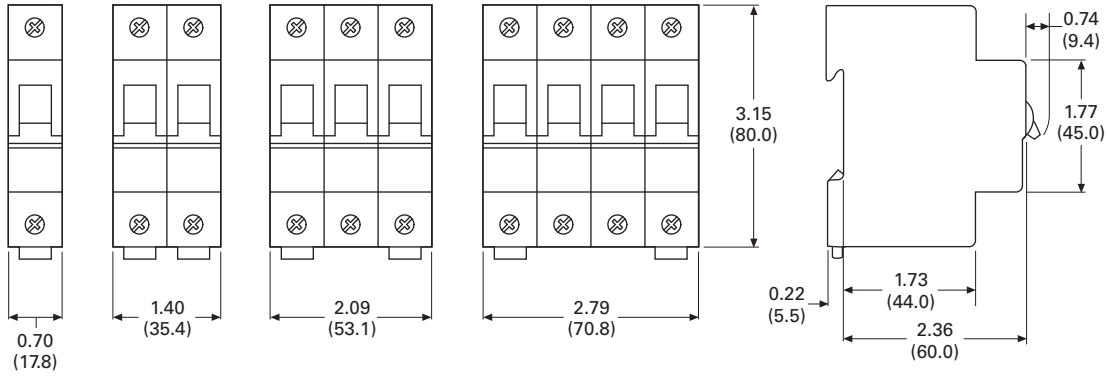

Auxiliary Contacts

FAZ-XHI11 and FAZ-XHI1NW1

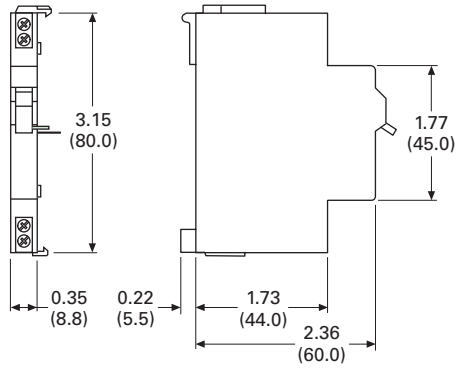

FAZ-XAM002

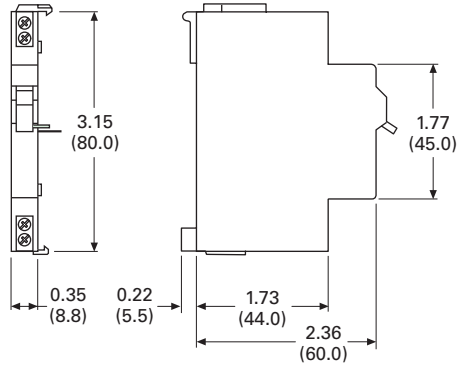

Shunt Releases

FAZ-XAA

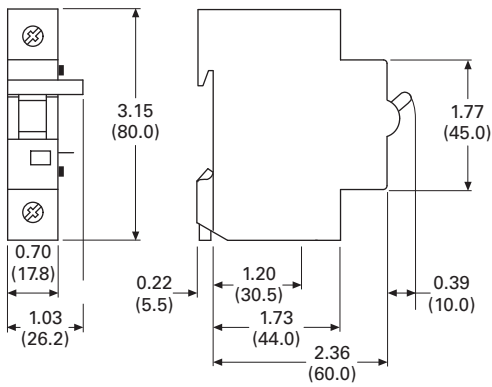

Undervoltage Releases

FAZ-XUA

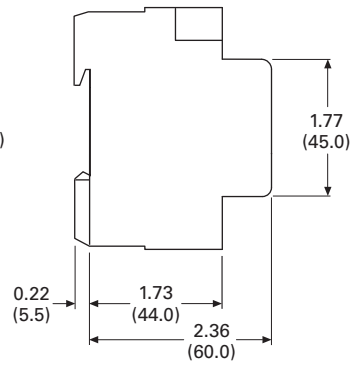

1.3

Miniature Circuit Breakers and Supplementary Protectors

UL 1077 DIN Rail Supplementary Protectors

1

Approximate Dimensions in Inches (mm)

Busbar and Accessory Weights and Dimensions

Unit Weight (kg)	Length	Width	Height	Catalog Number
0.29	39.72 (1009.0)	0.59 (15.0)	0.59 (15.0)	BB-UL-18/1P-1M/57
0.64	39.02 (991.0)	0.87 (22.0)	1.46 (37.0)	BB-UL-18/2P-2M/56
0.83	39.72 (1009.0)	0.87 (22.0)	1.46 (37.0)	BB-UL-18/3P-3M/57
0.26	38.78 (985.0)	0.59 (15.0)	0.59 (15.0)	BB-UL-18/1P-1.5M/37
0.63	39.72 (1009.0)	0.87 (22.0)	1.46 (37.0)	BB-UL-18/2P+AS-2.5M/46
0.79	38.66 (982.0)	0.87 (22.0)	1.46 (37.0)	BB-UL-18/3P+AS-3.5M/48
0.36	39.72 (1009.0)	0.59 (15.0)	0.59 (15.0)	BB-UL-25/1P-1M/57
0.79	39.02 (991.0)	0.87 (22.0)	1.46 (37.0)	BB-UL-25/2P-2M/56
1.04	39.72 (1009.0)	0.87 (22.0)	1.46 (37.0)	BB-UL-25/3P-3M/57
0.31	38.78 (985.0)	0.59 (15.0)	0.59 (15.0)	BB-UL-25/1P-1.5M/37
0.73	39.72 (1009.0)	0.87 (22.0)	1.46 (37.0)	BB-UL-25/2P+AS-2.5M/46
0.97	38.66 (982.0)	0.87 (22.0)	1.46 (37.0)	BB-UL-25/3P+AS-3.5M/48
0.03	2.36 (60.0)	0.67 (17.0)	1.14 (29.0)	BB-UL-TEP/35
0.03	1.42 (36.0)	0.67 (17.0)	1.14 (29.0)	BB-UL-TEPA/35
0.03	1.57 (40.0)	0.71 (18.0)	1.18 (30.0)	BB-UL-TE/50
0.003	3.35 (85.0)	0.47 (12.0)	0.94 (24.0)	BB-IP/5
0.001	0.55 (14.0)	0.20 (5.0)	0.39 (10.0)	BB-UL-EC/3
0.001	0.94 (24.0)	0.87 (22.0)	0.39 (10.0)	BB-UL-EC/1

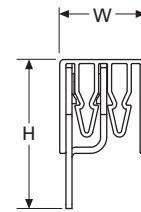
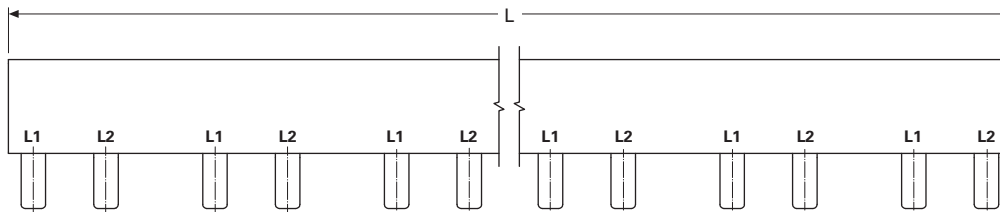

UL 1053 DIN Rail RCCB



Contents

Description

UL 1053 DIN Rail RCCB 480/277 Vac	
Product Selection	V4-T1-88
Accessories	V4-T1-89
Technical Data and Specifications	V4-T1-90
Dimensions	V4-T1-91
UL 1053 DIN Rail RCCB 208Y/120 Vac	V4-T1-93

UL 1053 DIN Rail RCCB 480/277 Vac

Product Overview

Optimum product quality, tested reliability and safety stand for best protection of installations and plant. Eaton's UL 1053 Residual Current Circuit Breaker (RCCB) is designed for use in residual current applications.

Application Description

- Motor control circuits
- HVAC internal/external equipment
- PLCs
- HMIs
- Equipment protection
- European housing

Features

- Wide range of compact RCCB types serving as fault-current and additional protection according to UL 1053 and IEC/EN 61008 standards, suitable for worldwide use
- Type A or Type G/A (with delay) protection available
- Comprehensive range of accessories
- Real contact position indicator
- Fault current tripping indicator
- Transparent designation plate
- Trip-free design—RCCB can not be defeated by holding the handle in the ON position
- Captive screws cannot be lost

Standards and Certifications

- UL 1053
- IEC/EN 61008
- CSA
- ÖVE
- CE Marked



Product Selection

UL 1053 RCCB 480Y/277V Type A

Two-Pole



Conditionally Surge Current–Proof 250A, Sensitive to Residual Pulsating DC, Type A

Two-Pole

Amperes	GF Sensitivity (mA)	Catalog Number ^①	Designation
25	30	167113	FRCmM-25/2/003-A-NA
	300	167116	FRCmM-25/2/03-A-NA
40	30	167114	FRCmM-40/2/003-A-NA
	300	167117	FRCmM-40/2/03-A-NA
63	30	167115	FRCmM-63/2/003-A-NA
	300	167118	FRCmM-63/2/03-A-NA

Four-Pole



Conditionally Surge Current–Proof 250A, Sensitive to Residual Pulsating DC, Type A

Four-Pole

Amperes	GF Sensitivity (mA)	Catalog Number ^①	Designation
25	30	167125	FRCmM-25/4/003-A-NA
	300	167104	FRCmM-25/4/03-A-NA
40	30	167102	FRCmM-40/4/003-A-NA
	300	167105	FRCmM-40/4/03-A-NA
63	30	167103	FRCmM-63/4/003-A-NA
	300	167106	FRCmM-63/4/03-A-NA

UL 1053 RCCB 480Y/277V Type G/A

Type G/A has a 10 ms delay.

Two-Pole



Surge Current–Proof 3 kA, Sensitive to Residual Pulsating DC, Type G/A (ÖVE E 8601)

Two-Pole

Amperes	GF Sensitivity (mA)	Catalog Number ^①	Designation
25	30	167119	FRCmM-25/2/003-G/A-NA
	300	167122	FRCmM-25/2/03-G/A-NA
40	30	167120	FRCmM-40/2/003-G/A-NA
	300	167123	FRCmM-40/2/03-G/A-NA
63	30	167121	FRCmM-63/2/003-G/A-NA
	300	167124	FRCmM-63/2/03-G/A-NA

Four-Pole



Surge Current–Proof 3 kA, Sensitive to Residual Pulsating DC, Type G/A (ÖVE E 8601)

Four-Pole

Amperes	GF Sensitivity (mA)	Catalog Number ^①	Designation
25	30	167107	FRCmM-25/4/003-G/A-NA
	300	167110	FRCmM-25/4/03-G/A-NA
40	30	167108	FRCmM-40/4/003-G/A-NA
	300	167111	FRCmM-40/4/03-G/A-NA
63	30	167109	FRCmM-63/4/003-G/A-NA
	300	167112	FRCmM-63/4/03-G/A-NA

Note

^① Has no thermal element; must be paired with FAZ-NA or FAZ per application.

Accessories

UL 1053 DIN Rail RCCB 480/277 Vac

Contact



Description	Catalog Number
Two-pole contact or auxiliary contact / trip indicating contact	Z-NHK ^①

Padlock Hasp

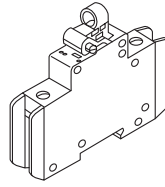

Description	Catalog Number
Padlock hasp	IS/SPE-1TE

Note

^① Voltage of FAZ-NA circuit breaker is limited to 300V with this auxiliary contact installed.

Technical Data and Specifications

- Residual current devices
- Has no thermal protection; must be paired with FAZ-NA or FAZ per application
- Captive screw terminals
- Universal tripping signal switch, also suitable for Z-A; can be mounted subsequently
- Auxiliary switch Z-HK can be mounted subsequently
- Red-green contact position indicator
- White-blue tripping indicator
- Delayed types recommended for use with standard fluorescent tubes with or without electronical ballast (30mA-RCD: 30 units per phase conductor, 100mA-RCD: 90 units per phase conductor)
- The device functions irrespective of the position of installation
- Tripping is line voltage-independent. Consequently, the RCD is suitable for "fault current/residual current protection" and "additional protection" within the meaning of the applicable installation rules
- Reverse-feed permitted
- The four-pole device can also be used for two-pole connection. For this purpose, use terminals 5-6 and N-N
- The test key "T" must be pressed every month. The system operator must be informed of this obligation and responsibility in a way that can be proven (self-adhesive RCD-label enclosed)
- Pressing the test key "T" serves the only purpose of function testing the residual current device (RCD). This test does not make earthing resistance measurement (RE) or proper checking of the earth conductor condition redundant, which must be performed separately
- **Type -A:** Protects against special forms of residual pulsating DC that have not been smoothed
- **Type -G/A:** Additionally protects against special forms of residual pulsating DC that have not been smoothed

UL 1053 DIN Rail RCCB Technical Data

Description	Specification	
Electrical According to IEC/EN 61008		
Design according to	IEC/EN 61008 ÖVE E 8601	
Current test marks as printed onto the device		
Tripping Type G	10 ms delay	
Rated voltage U_n	230/400V, 50 Hz	
Rated tripping current $I_{\Delta n}$	30, 300 mA	
Sensitivity	AC and pulsating DC	
Rated insulation voltage U_i	440V	
Rated impulse withstand voltage U_{imp}	4 kV	
Rated short-circuit capacity I_{nc}	10 kA	
Maximum backup fuse	Overload protection	Short-circuit protection
$I_n = 25-40A$	25A gG/gL	63A gG/gL
$I_n = 63A$	40A gG/gL	63A gG/gL
Rated breaking capacity I_m bzw. Rated fault breaking capacity $I_{\Delta m}$		
$I_n = 25-40A$	500A	
$I_n = 63A$	630A	
Voltage range of test button	Two-pole	184–250V~
	Four-pole	184–440V~
Endurance	Electrical	>4000 operating cycles
	Mechanical	>20,000 operating cycles
Overvoltage category	III	

UL 1053 DIN Rail RCCB Technical Data, continued

Description	Specification	
Electrical According to UL 1053		
Design according to	UL 1053	
Current test marks as printed onto the device		
Tripping Type G	8 ms delay	
Rated voltage U_n	480Y/277V, 60 Hz	
Pickup current	22, 200 mA	
Sensitivity	AC and pulsating DC	
Overvoltage tested	530V	
Rated impulse withstand voltage U_{imp}	4 kV	
Rated short-circuit capacity I_{nc}	5 kA according to CSA	
Maximum backup fuse	Overload protection	Short-circuit protection
$I_n = 25-40A$	25A gG/gL	63A gG/gL
$I_n = 63A$	40A gG/gL	63A gG/gL
Rated breaking capacity I_m or Rated fault breaking capacity $I_{\Delta m}$		
$I_n = 25-40A$	500A	
$I_n = 63A$	630A	
Voltage range of test button	Two-pole	184–305V~
	Four-pole	184–528V~
Endurance	Electrical	>4000 operating cycles
	Mechanical	>20,000 operating cycles
Mechanical		
Frame size	45.0 mm	
Device height	80.0 mm	
Device width	35 mm (2TE), 70 mm (4TE)	
Device width	Quick fastening with two lock-in positions on DIN rail IEC/EN 60715	
Degree of protection, built-in	IP40	
Degree of protection in moisture-proof enclosure	IP54	
Upper and lower terminals	Lift terminals	
Terminal protection	Finger and hand touch safe BGV A3, ÖVE-EN 6	
Terminal capacity	1.5–35 mm ² single-wire	
	2 x 16 mm ² multi-wire	
Busbar material thickness	0.8–2 mm	
Tripping temperature	–25°C to +60°C	
Resistance to climatic conditions	According to IEC 61008	
Humidity	5–95%	

Connection Diagram

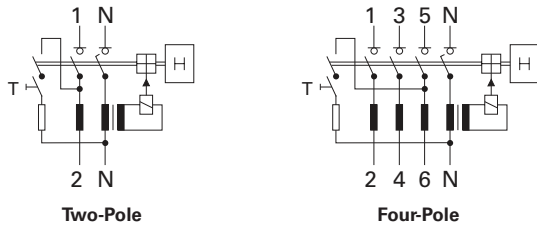

Impact of Ambient Temperature on the Maximum Permanent Current Allowed (A)

Tripping Temperature	16A		25A		40A		63A	
	Two-Pole	Four-Pole	Two-Pole	Four-Pole	Two-Pole	Four-Pole	Two-Pole	Four-Pole
40°C	16	16	25	25	40	40	63	63
45°C	14	14	21	22	37	37	59	59
50°C	11	11	18	19	33	34	55	55
55°C	9	9	14	16	30	31	50	50
60°C	①	—	—	—	26	27	45	45

Notes

① Do not use.

Please make sure that these values are not exceeded and that any upstream overload protection switches off in time.

Correct Connection

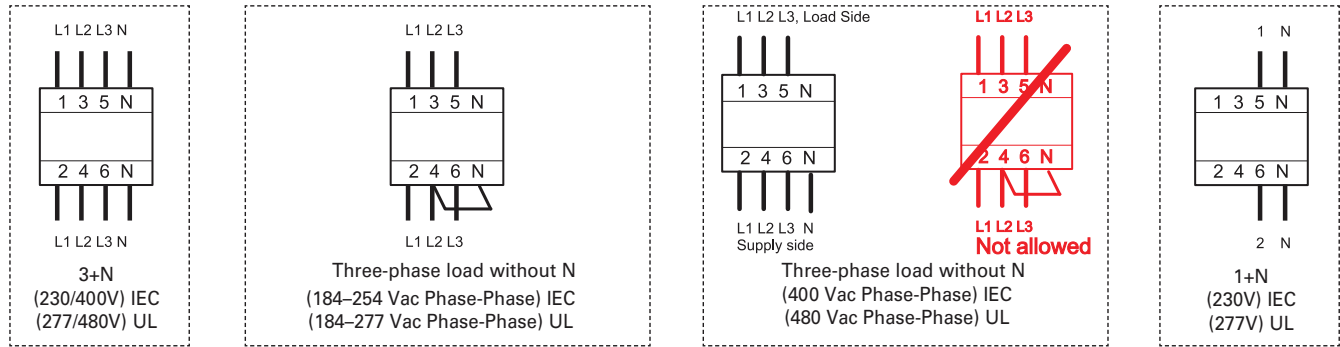

Dimensions

Approximate Dimensions in Inches (mm)

UL 1053 DIN Rail RCCB

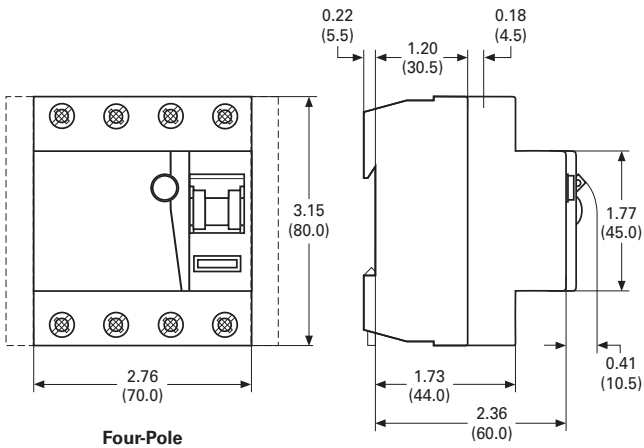

Accessories Technical Data

Description	Z-NHK
Electrical	
Contact function	2CO
Rated voltage	230V
Frequency	50/60 Hz
Rated current	2A
Rated thermal current I_{th}	2A
Utilization category AC13 Rated operational current I_b	3A/250 Vac
Utilization category AC15 Rated operational current I_b	2A/250 Vac
Utilization category DC12 Rated operational current I_b	0.5A/110 Vdc
Rated insulation voltage U_i	250 Vac
Minimum operational voltage per contact U_{min}	5 Vdc
Minimum operational current I_{min}	10 mA DC
Rated peak withstand voltage U_{imp} (1.2/50 μ)	2.5 kV
Conditional short-circuit current I_k with backup fuse 6A	1 kA
Maximum backup fuse, overload and short circuit	6A gL
Mechanical	
Tripping indicator "electrical tripping"	Blue/white
Frame size	45 mm
Device height	80 mm
Device width	8.8 mm (0.5MU)
Mounting	Onto switching device
Degree of protection, built-in	IP40
Terminal protection	Finger and hand touch safe According to BGV A3, ÖVE-EN 6
Terminals	Lift terminals
Terminal capacity	20–14 AWG
Terminal screws	M3 (Posidrive Z0)
Fastening torque of terminal screws	7 lb-in maximum

UL 1053 DIN Rail RCCB



Contents

Description

<i>Description</i>	<i>Page</i>
UL 1053 DIN Rail RCCB 480/277 Vac	V4-T1-87
UL 1053 DIN Rail RCCB 208Y/120 Vac	
Product Selection	V4-T1-94
Accessories	V4-T1-95
Technical Data and Specifications	V4-T1-96
Dimensions	V4-T1-97

UL 1053 DIN Rail RCCB 208Y/120 Vac

Product Overview

Optimum product quality, tested reliability and safety stand for best protection of installations and plant. Eaton's UL 1053 Residual Current Circuit Breaker (RCCB) is designed for use in residual current applications.

Application Description

- Motor control circuits
- HVAC internal/external equipment
- PLCs
- HMIs
- Equipment protection

Features

- Wide range of compact RCD type serving as fault-current and additional protection according to UL 1053 and IEC/EN 61008 standards, suitable for worldwide use in the 110V range of applications
- Type A or Type G/A (with delay) protection available
- Comprehensive range of accessories
- Real contact position indicator
- Fault current tripping indicator
- Transparent designation plate
- Trip-free design—RCCB can not be defeated by holding the handle in the ON position
- Captive screws cannot be lost

Standards and Certifications

- UL 1053
- IEC/EN 61008



Product Selection

UL 1053 RCCB 208Y/120 Vac Type A**Four-Pole****Conditionally Surge Current–Proof 250A, Sensitive to Residual Pulsating DC, Type A****Four-Pole**

Amperes	GF Sensitivity (mA)	Catalog Number ^①	Designation
25	30	167699	FRCmM-25/4/003-A-NA-110
	300	167702	FRCmM-25/4/03-A-NA-110
40	30	167700	FRCmM-40/4/003-A-NA-110
	300	167703	FRCmM-40/4/03-A-NA-110
63	30	167701	FRCmM-63/4/003-A-NA-110
	300	167704	FRCmM-63/4/03-A-NA-110

UL 1053 RCCB 208Y/120 Vac Type G/A

Type G/A has a 10 ms delay.

Two-Pole**Surge Current–Proof 3 kA, Sensitive to Residual Pulsating DC, Type G/A (ÖVE E 8601)****Two-Pole**

Amperes	GF Sensitivity (mA)	Catalog Number ^①	Designation
25	30	167693	FRCmM-25/2/003-G/A-NA-110
	300	167696	FRCmM-25/2/03-G/A-NA-110
40	30	167694	FRCmM-40/2/003-G/A-NA-110
	300	167697	FRCmM-40/2/03-G/A-NA-110
63	30	167695	FRCmM-63/2/003-G/A-NA-110
	300	167698	FRCmM-63/2/03-G/A-NA-110

Four-Pole**Surge Current–Proof 3 kA, Sensitive to Residual Pulsating DC, Type G/A (ÖVE E 8601)****Four-Pole**

Amperes	GF Sensitivity (mA)	Catalog Number ^①	Designation
25	30	167705	FRCmM-25/4/003-G/A-NA-110
	300	167708	FRCmM-25/4/03-G/A-NA-110
40	30	167706	FRCmM-40/4/003-G/A-NA-110
	300	167709	FRCmM-40/4/03-G/A-NA-110
63	30	167707	FRCmM-63/4/003-G/A-NA-110
	300	167710	FRCmM-63/4/03-G/A-NA-110

Note^① Has no thermal element; must be paired with FAZ-NA or FAZ per application.

Accessories

UL 1053 DIN Rail RCCB 208Y/120 Vac

Contact



Description	Catalog Number
Two-pole contact or auxiliary contact / trip indicating contact	Z-NHK ①

Padlock Hasp

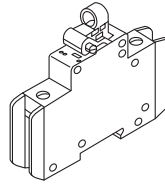

Description	Catalog Number
Padlock hasp	IS/SPE-1TE

Note

① Voltage of FAZ-NA circuit breaker is limited to 300V with this auxiliary contact installed.

Technical Data and Specifications

- Residual current devices
- Has no thermal protection; must be paired with FAZ-NA or FAZ per application
- Captive screw terminals
- Universal tripping signal switch, also suitable for Z-A; can be mounted subsequently
- Auxiliary switch Z-HK can be mounted subsequently
- Red-green contact position indicator
- White-blue tripping indicator
- Delayed types recommended for use with standard fluorescent tubes with or without electronical ballast (30mA-RCD: 30 units per phase conductor, 100mA-RCD: 90 units per phase conductor)
- The device functions irrespective of the position of installation
- Tripping is line voltage-independent. Consequently, the RCD is suitable for “fault current/residual current protection” and “additional protection” within the meaning of the applicable installation rules
- Reverse-feed permitted
- The four-pole device can also be used for two-pole connection. For this purpose, use terminals 5-6 and N-N
- The test key “T” must be pressed every month. The system operator must be informed of this obligation and responsibility in a way that can be proven (self-adhesive RCD-label enclosed)
- Pressing the test key “T” serves the only purpose of function testing the residual current device (RCD). This test does not make earthing resistance measurement (RE) or proper checking of the earth conductor condition redundant, which must be performed separately
- **Type -A:** Protects against special forms of residual pulsating DC that have not been smoothed
- **Type -G/A:** Additionally protects against special forms of residual pulsating DC that have not been smoothed

UL 1053 DIN Rail RCCB Technical Data

Description	Specification	
Electrical According to IEC/EN 61008		
Design according to	IEC/EN 61008 ÖVE E 8601	
Current test marks as printed onto the device		
Tripping Type G	10 ms delay	
Rated voltage U_n	230/400V, 50 Hz	
Rated tripping current $I_{\Delta n}$	30, 300 mA	
Sensitivity	AC and pulsating DC	
Rated insulation voltage U_i	440V	
Rated impulse withstand voltage U_{imp}	4 kV	
Rated short-circuit capacity I_{nc}	10 kA	
Maximum backup fuse	Overload protection	Short-circuit protection
$I_n = 25-40A$	25A gG/gL	63A gG/gL
$I_n = 63A$	40A gG/gL	63A gG/gL
Rated breaking capacity I_m bzw. Rated fault breaking capacity $I_{\Delta m}$		
$I_n = 25-40A$	500A	
$I_n = 63A$	630A	
Voltage range of test button	Two-pole	100–132V–
	Four-pole	100–230V–
Endurance	Electrical	>4000 operating cycles
	Mechanical	>20,000 operating cycles
Overvoltage category	III	

UL 1053 DIN Rail RCCB Technical Data, continued

Description	Specification	
Electrical According to UL1053		
Design according to	UL 1053	
Current test marks as printed onto the device		
Tripping Type G	8 ms delay	
Rated voltage U_n	208Y/120V, 60 Hz	
Pickup current	22, 200 mA	
Sensitivity	AC and pulsating DC	
Overvoltage tested	530V	
Rated impulse withstand voltage U_{imp}	4 kV	
Rated short-circuit capacity I_{nc}	5 kA according to CSA	
Maximum backup fuse	Overload protection	Short-circuit protection
$I_n = 25-40A$	25A gG/gL	63A gG/gL
$I_n = 63A$	40A gG/gL	63A gG/gL
Rated breaking capacity I_m or Rated fault breaking capacity $I_{\Delta m}$		
$I_n = 25-40A$	500A	
$I_n = 63A$	630A	
Voltage range of test button	Two-pole	100–121V–
	Four-pole	100–210V–
Endurance	Electrical	>4000 operating cycles
	Mechanical	>20,000 operating cycles
Mechanical		
Frame size	45.0 mm	
Device height	80.0 mm	
Device width	35 mm (2TE), 70 mm (4TE)	
Device width	Quick fastening with two lock-in positions on DIN rail IEC/EN 60715	
Degree of protection, built-in	IP40	
Degree of protection in moisture-proof enclosure	IP54	
Upper and lower terminals	Lift terminals	
Terminal protection	Finger and hand touch safe BGV A3, ÖVE-EN 6	
Terminal capacity	1.5–35 mm ² single-wire	
	2 x 16 mm ² multi-wire	
Busbar material thickness	0.8–2 mm	
Tripping temperature	–25°C to +60°C	
Resistance to climatic conditions	According to IEC 61008	
Humidity	5–95%	

Connection Diagram

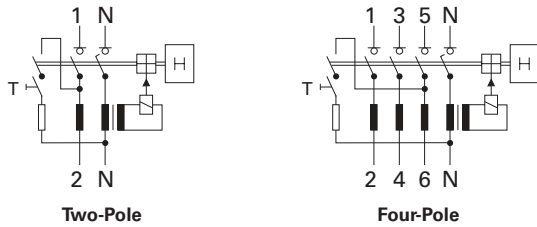

Impact of Ambient Temperature on the Maximum Permanent Current Allowed (A)

Tripping Temperature	16A		25A		40A		63A	
	Two-Pole	Four-Pole	Two-Pole	Four-Pole	Two-Pole	Four-Pole	Two-Pole	Four-Pole
40°C	16	16	25	25	40	40	63	63
45°C	14	14	21	22	37	37	59	59
50°C	11	11	18	19	33	34	55	55
55°C	9	9	14	16	30	31	50	50
60°C	①	—	—	—	26	27	45	45

Notes

① Do not use.

Please make sure that these values are not exceeded and that any upstream overload protection switches off in time.

Correct Connection

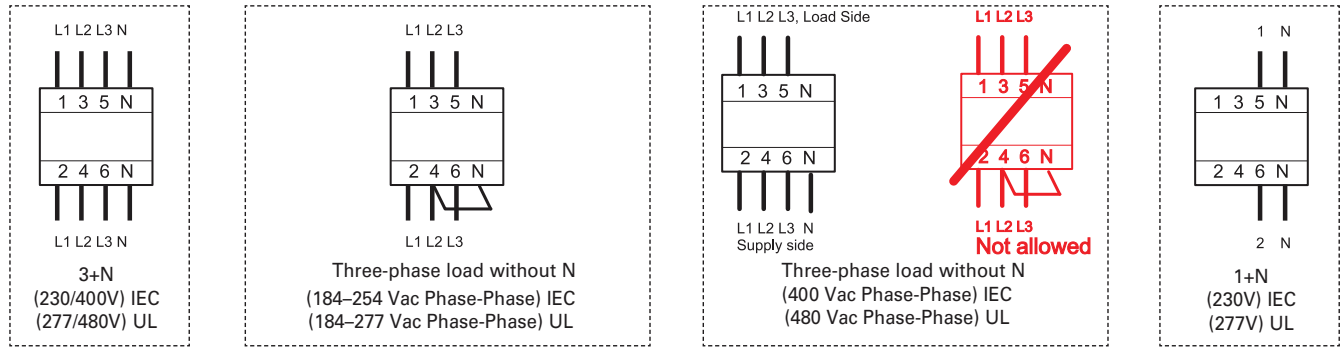

Dimensions

Approximate Dimensions in Inches (mm)

UL 1053 DIN Rail RCCB

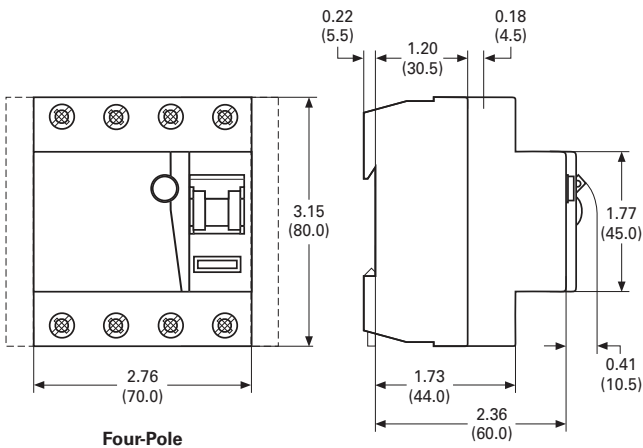

Accessories Technical Data

Description	Z-NHK	Z-IHK-NA
Electrical		
Contact function	2CO	1NO + 1NC
Rated voltage	230V	250V
Frequency	50/60 Hz	50/60 Hz
Rated current	2A	6A
Rated thermal current I_{th}	2A	6A
Utilization category AC13 Rated operational current I_b	3A/250 Vac	3A/250 Vac
Utilization category AC15 Rated operational current I_b	2A/250 Vac	2A/250 Vac
Utilization category DC12 Rated operational current I_b	0.5A/110 Vdc	0.5A/110 Vdc 0.25A/220 Vdc
Rated insulation voltage U_i	250 Vac	250 Vac
Minimum operational voltage per contact U_{min}	5 Vdc	5 Vdc
Minimum operational current I_{min}	10 mA DC	10 mA AC/DC
Rated peak withstand voltage U_{imp} (1.2/50 μ)	2.5 kV	4 kV
Conditional short-circuit current I_k with backup fuse 6A	1 kA	1 kA
Maximum backup fuse, overload and short circuit	6A gL	—
Mechanical		
Tripping indicator "electrical tripping"	Blue/white	—
Frame size	45 mm	45 mm
Device height	80 mm	80 mm
Device width	8.8 mm (0.5MU)	8.8 mm (0.5MU)
Mounting	Onto switching device	—
Degree of protection, built-in	IP40	IP40
Terminal protection	Finger and hand touch safe According to BGV A3, ÖVE-EN 6	Finger and hand touch safe According to BGV A3, ÖVE-EN 6
Terminals	Lift terminals	Lift terminals
Terminal capacity	20–14 AWG	0.5–2.5 mm ²
Terminal screws	M3 (Posidrive Z0)	M3 (Posidrive Z0)
Fastening torque of terminal screws	7 lb-in maximum	1.2 Nm