

CATALOG

Ty-Duct®

Wiring duct



**Thomas & Betts is now ABB
Installation Products, but our long
legacy of quality products and
innovation remains the same. From
connectors that help wire buildings
on Earth to cable ties that help put
machines in space, we continue to
work every day to make, market,
design and sell products that
provide a smarter, safer and more
reliable flow of electricity, from
source to socket.**

Table of contents

002–007	Overview
009–028	Product ordering and information
029–040	Appendix

Overview

The versatile configurations you need for routing and concealing wiring

ABB's innovative Ty-Duct products offer a total solution for routing and concealing wiring in control panels. Many different sizes are available to accommodate anything from the smallest wall-mount panel to larger integrated systems. Impressive features are incorporated into all of our wiring duct solutions.

Ty-Duct wiring duct features

- Available in solid, wide slot, narrow slot and round hole versions to meet your capacity and flexibility needs
- Widths from 0.75" to 6" and depths from 1" to 5"
- Optional adhesive back for quick, hassle-free installation
- Complete selection of accessories and tools for installation
- Lead-free construction
- Lightweight halogen-free unit available for wide and narrow slot wiring duct (metric duct only)

Ty-Duct wiring duct certifications

- UL recognized continuous-use temperature from -40 °C (-40 °F) up to 60 °C (140 °F)
- CSA certified file no. 110176
- UL flammability rating of UL94V-0
- CE compliant
- RoHS compliant

Metric duct certifications

- CSA certified file no. 077988
- RoHS compliant
- Conforms to EN50085-2-3 standard
- DIN standard mounting holes

Available in four colors

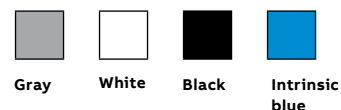

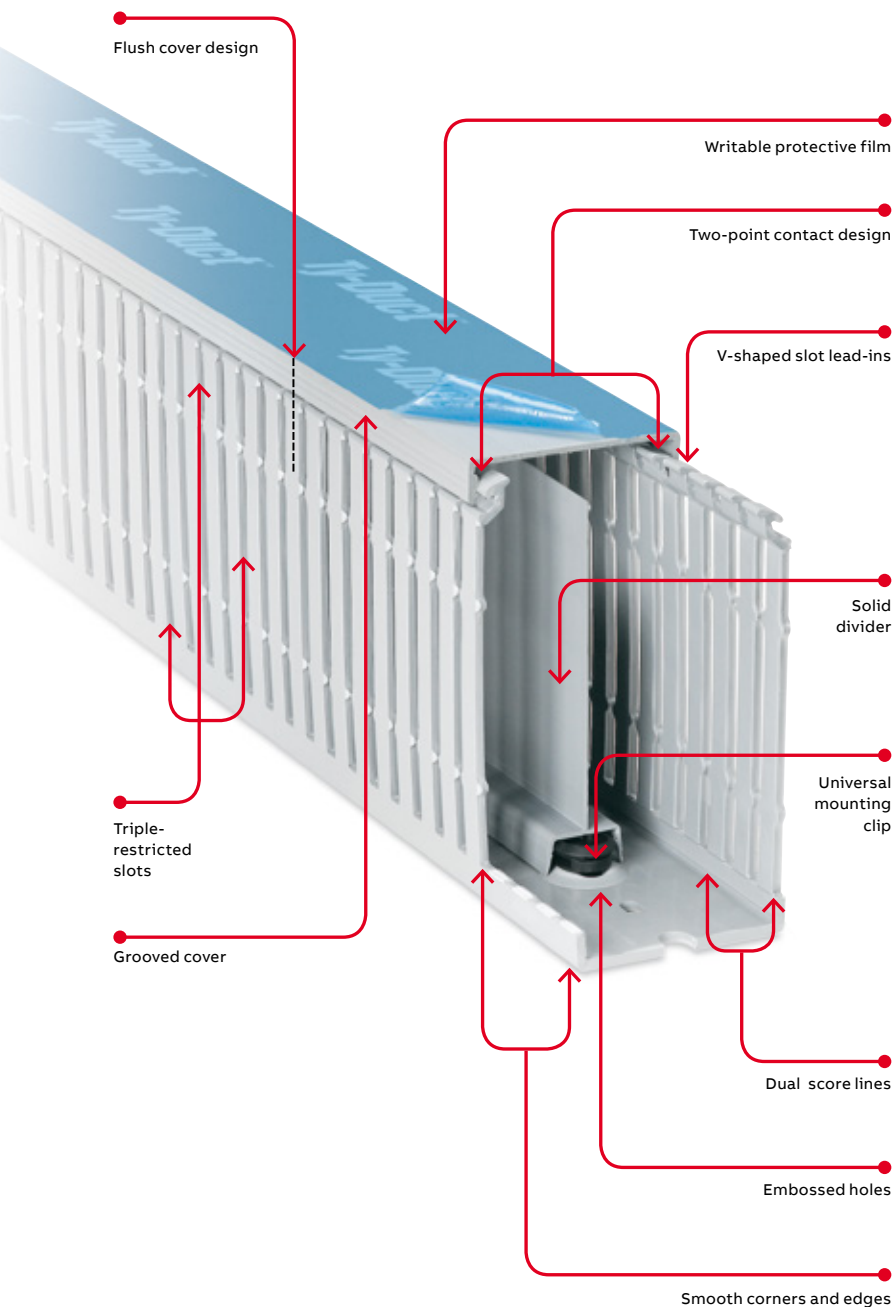

Ty-Duct wiring duct advantages

- Two-point contact design enables the cover to be easily installed in the right place with less force
- Co-extruded cover ensures the cover will stay in place once installed
- Smooth corners and edges protect wires
- Flush cover design enables greater capacity and sits flush with duct side wall
- Triple-restricted slots speed installation while enabling better wire retaining in duct
- Score lines — upper score line allows fingers to be broken out without tools
- V-shaped slot lead-in funnels wires into slot for easier wire insertion
- Universal mounting clip secures into base to perform several tasks:
 - Enables divider to be snapped into base
 - Slots in the universal mounting clip allow cable ties to pass through to hold wire bundles in place
 - Two slot sizes on universal mounting clip accommodate traditional nylon cable ties or hook-and-loop fasteners
- Slotted and solid dividers accommodate various wiring applications
- Grooved cover provides better grip for removal and placement of cover onto base
- Writable protective film on covers protects against job site scratches and scuffs and enables temporary marking or labeling
- Embossed holes enable universal mounting clips to be installed, even after the duct has been riveted to the panel
- PVC construction is excellent for flame retardancy
- North American and DIN standard mounting holes

Overview

Wiring duct styles

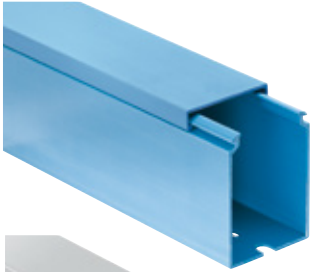

Solid wall wiring duct

- Engineered to restrict wire access for greater security
- Available in improved flush sidewall and cover style for greater wire capacity

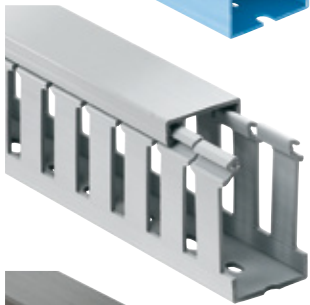

Wide slot wiring duct

- Wide fingers and slots increase rigidity and enable easy insertion of bundles
- Halogen-free version available



Narrow slot wiring duct

- Smaller, higher number of fingers for more concise harnessing
- Finger design restricts wire from slipping along the edge — creates two or three levels of wire service



Round hole wiring duct

- Multiple rows of holes retain wire at different heights and positions with or without cover
- Features maximum number of wire holes



Metric wiring duct

- Lead-free thermoplastic duct
- Available in wide and narrow slot styles
- Covers included with all duct orders



Halogen-free thermoplastic metric duct

- Available in wide and narrow slot wiring duct
- Available in gray
- Covers included with all duct orders

Overview

How to order





Ordering the Ty-Duct products you need is as easy as 1, 2, 3.

After selecting the appropriate Ty-Duct solutions for your application, make sure you complete the following checklist.

For Ty-Duct wiring duct and covers:

1. Specify color
2. Indicate if you want the duct without mounting holes
3. Indicate if you want an adhesive-backed duct (not available with halogen-free duct)

 = space for color identifier:

- G = Gray 
- W = White 
- B = Black 
- I = Intrinsic blue 



2. To order duct without mounting holes, add suffix NM to catalog number.
Example: TYD75X1WPG6NM is a 0.75" x 1" wide slot gray duct with no mounting holes.

3. To order adhesive-backed duct, add suffix A to Catalog Number. Example: TYD75x15WPB6A is a 0.75" x 1.5" wide slot black duct with adhesive backing. Shelf life for adhesive is 1 year.

Cat. no.	Description	Nominal width x nominal height		Cover cat. no.	Duct std. ctn. qty.	Cover std. ctn. qty.	Length (ft.)
		In.	mm				
TYD75X1WP[G]6[NM]	0.75 x 1 wide slot duct	0.94 x 1.09	23.9 x 27.7	TYD75CP[G]6	120	120	6
TYD75X15WP[B]6[A]	0.75 x 1.5 Wide slot duct	0.94 x 1.56	23.9 x 39.6		120		
TYD75X2WP[I]6	0.75 x 2 wide slot duct	0.94 x 2.07	23.9 x 52.6		120		

SP = Solid
WP = Wide slot
NP = Narrow slot
RP = Round hole

1. Catalog number must be completed by adding suffix G for gray, W for white, I for intrinsic blue, B for black. Example: TYD75x2WPI6 is a 0.75" x 2" wide slot intrinsic blue duct. Cover color must be specified also.

Standard carton quantity

Standard lengths are 6 feet.

For Ty-Duct dividers:



Catalog number must be completed by adding suffix SP for solid or WP for wide slot. Example: TY2DSPG6 is a 2" high solid wall gray divider.

Cat. no.	Description	Length (ft.)	Std. ctn. qty
TY2D[SP][G]6	2" High wall divider	6	120

Catalog number must be completed by adding suffix G for gray, W for white, I for intrinsic blue, B for black. Example: TY2DSPG6 is a 2" high solid wall gray divider.

For Ty-Duct corner and joining strips:

Corner strip sample shown below. Joining strips are ordered the same way.

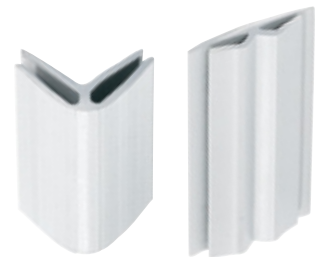

Cat. no.	Description	Length (ft.)	Std. ctn. qty
TYCS[G]6	Corner strip	6	120

Catalog number must be completed by adding suffix G for gray, W for white, I for intrinsic blue, B for black. Example: TYCSG6 is a gray corner strip.

Product ordering and information

010–011	Solid wall wiring duct
012–013	Wide slot wiring duct
014–015	Narrow slot wiring duct
016–017	Round hole wiring duct
018–020	Metric wide and narrow slot wiring duct
021–023	Metric halogen-free wide and narrow slot wiring duct
024–026	Accessories
027–028	Tools

Product ordering and information

Solid wall wiring duct

Flame-retardant PVC offers the protection you need.

Solid wall duct — PVC

- Engineered to restrict wire access
- Constructed of flame-retardant PVC
- Non-slip cover does not slide easily and resists vibration
- Cover attaches flush with sidewall for finished look
- Improved flush sidewall and cover style for greater wire capacity
- Base score line
- Integrated mounting holes — larger sizes include staggered holes for mounting flexibility (see page 32 for illustration)
- Lead-free construction

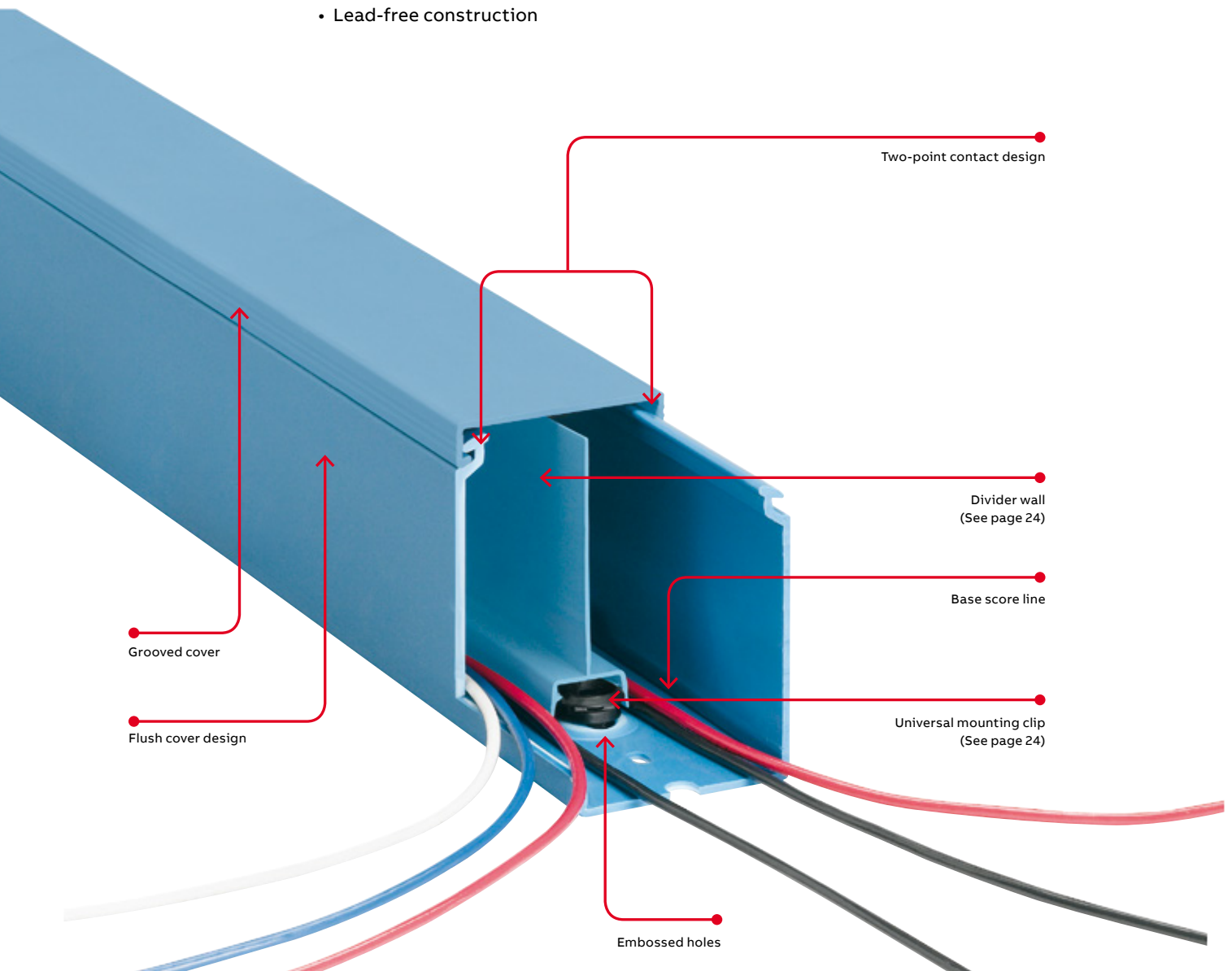

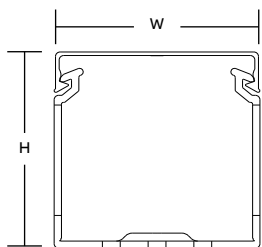

Front view with cover



Side view

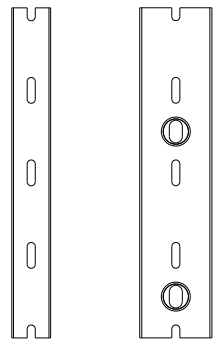

Pattern for 3/4" & 1"

Pattern for 1 1/2"

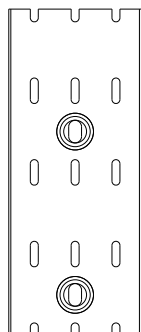

Pattern for 2", 2 1/2", 3", 4" & 6"

For a complete listing of solid wall dimensional details, see page 32.



Cat. no.	Description (in.)	Size (W x H)		Cover cat. no.	Duct std. ctn. qty.	Cover std. ctn. qty.	Length (ft.)
		in.	mm				
TYD75X1SP[_]6	0.75 x 1 Solid wall duct	0.94 x 1.14	23.9 x 27.7	TYD75CP[_]6	120	60	6
TYD75X15SP[_]6	0.75 x 1.5 Solid wall duct	0.94 x 1.60	23.9 x 39.6				
TYD75X2SP[_]6	0.75 x 2 Solid wall duct	0.94 x 2.10	23.9 x 52.6				
TYD1X1SP[_]6	1 x 1 Solid wall duct	1.25 x 1.14	31.8 x 27.7	TYD1CP[_]6	120	60	6
TYD1X15SP[_]6	1 x 1.5 Solid wall duct	1.25 x 1.60	31.8 x 39.9				
TYD1X2SP[_]6	1 x 2 Solid wall duct	1.25 x 2.10	31.8 x 52.8				
TYD1X3SP[_]6	1 x 3 Solid wall duct	1.25 x 3.05	31.8 x 77.7				
TYD1X4SP[_]6	1 x 4 Solid wall duct	1.25 x 4.37	31.8 x 111.3		60		
TYD15X1SP[_]6	1.5 x 1 Solid wall duct	1.75 x 1.14	44.5 x 27.7	TYD15CP[_]6	120	60	6
TYD15X15SP[_]6	1.5 x 1.5 Solid wall duct	1.75 x 1.60	44.5 x 39.9				
TYD15X2SP[_]6	1.5 x 2 Solid wall duct	1.75 x 2.10	44.5 x 52.8				
TYD15X3SP[_]6	1.5 x 3 Solid wall duct	1.75 x 3.05	44.5 x 77.7				
TYD15X4SP[_]6	1.5 x 4 Solid wall duct	1.75 x 4.37	44.5 x 111.3		60		
TYD2X1SP[_]6	2 x 1 Solid wall duct	2.25 x 1.24	57.2 x 28.4	TYD2CP[_]6	120	60	6
TYD2X15SP[_]6	2 x 1.5 Solid wall duct	2.25 x 1.70	57.2 x 40.4				
TYD2X2SP[_]6	2 x 2 Solid wall duct	2.25 x 2.19	57.2 x 53.3				
TYD2X3SP[_]6	2 x 3 Solid wall duct	2.25 x 3.14	57.2 x 78.2		60		
TYD2X4SP[_]6	2 x 4 Solid wall duct	2.25 x 4.46	57.2 x 111.8				
TYD2X5SP[_]6	2 x 5 Solid wall duct	2.25 x 5.15	57.2 x 129.3				
TYD25X2SP[_]6	2.5 x 2 Solid wall duct	2.75 x 2.19	69.9 x 53.6	TYD25CP[_]6	120	60	6
TYD25X3SP[_]6	2.5 x 3 Solid wall duct	2.75 x 3.14	69.9 x 78.2		60		
TYD25X4SP[_]6	2.5 x 4 Solid wall duct	2.75 x 4.46	69.9 x 111.8				
TYD3X1SP[_]6	3 x 1 Solid wall duct	3.25 x 1.24	82.6 x 29.0	TYD3CP[_]6	120	60	6
TYD3X2SP[_]6	3 x 2 Solid wall duct	3.25 x 2.19	82.6 x 54.9		60		
TYD3X3SP[_]6	3 x 3 Solid wall duct	3.25 x 3.14	82.6 x 79.8				
TYD3X4SP[_]6	3 x 4 Solid wall duct	3.25 x 4.46	82.6 x 113.5				
TYD3X5SP[_]6	3 x 5 Solid wall duct	3.25 x 5.15	82.6 x 130.6				
TYD4X15SP[_]6	4 x 1.5 Solid wall duct	4.25 x 1.70	108.0 x 42.4	TYD4CP[_]6	60	30	6
TYD4X2SP[_]6	4 x 2 Solid wall duct	4.25 x 2.19	108.0 x 55.1				
TYD4X3SP[_]6	4 x 3 Solid wall duct	4.25 x 3.14	108.0 x 80.0				
TYD4X4SP[_]6	4 x 4 Solid wall duct	4.25 x 4.46	108.0 x 113.8		30		
TYD4X5SP[_]6	4 x 5 Solid wall duct	4.25 x 5.15	108.0 x 130.8				
TYD6X4SP[_]6	6 x 4 Solid wall duct	6.25 x 4.46	158.8 x 114.0	TYD6CP[_]6	30	30	6

[] = space for color identifier:

- G = Gray
- W = White
- B = Black
- I = Intrinsic blue

- Standard lengths are 6 feet.
- + Catalog number must be completed by adding suffix G for gray, W for white, I for intrinsic blue, B for black.
- Example: TYD75X1SPG6 is a 0.75" x 1" solid wall gray duct.
- To order duct without mounting holes, add suffix NM to catalog number.
- Example: TYD75X1SPGNM6 is a 0.75" x 1" solid wall gray duct with no mounting holes.
- To order adhesive-backed duct, add suffix A to catalog number.
- Example: TYD75X1SPGA6 is a 0.75" x 1" solid wall gray duct with adhesive backing. Shelf life for adhesive is 1 year.
- PVC vinyl duct is CSA certified, UL recognized and CE compliant.

Product ordering and information

Wide slot wiring duct

Greater sidewall rigidity with increased versatility.

Wide slot wiring duct — PVC

- Wide fingers and slots increase rigidity and enable easier insertion of wiring bundles
- Non-slip cover does not slide easily and resists vibration
- Rounded edges keep hands and wires free of abrasion
- Dual score lines are designed to yield clean breakoffs at the base of the slot and the duct
- Restricted slot design ensures that wires are held with or without the cover inserted
- Cover attaches flush with sidewall for finished look
- Improved flush sidewall and cover style for greater wire capacity
- Versatile North American and DIN standard mounting holes enable use of the same duct for multiple applications
- Constructed of flame-retardant PVC
- Integrated mounting holes — larger sizes include staggered holes for mounting flexibility (see page 33 for illustration)
- Lead-free construction

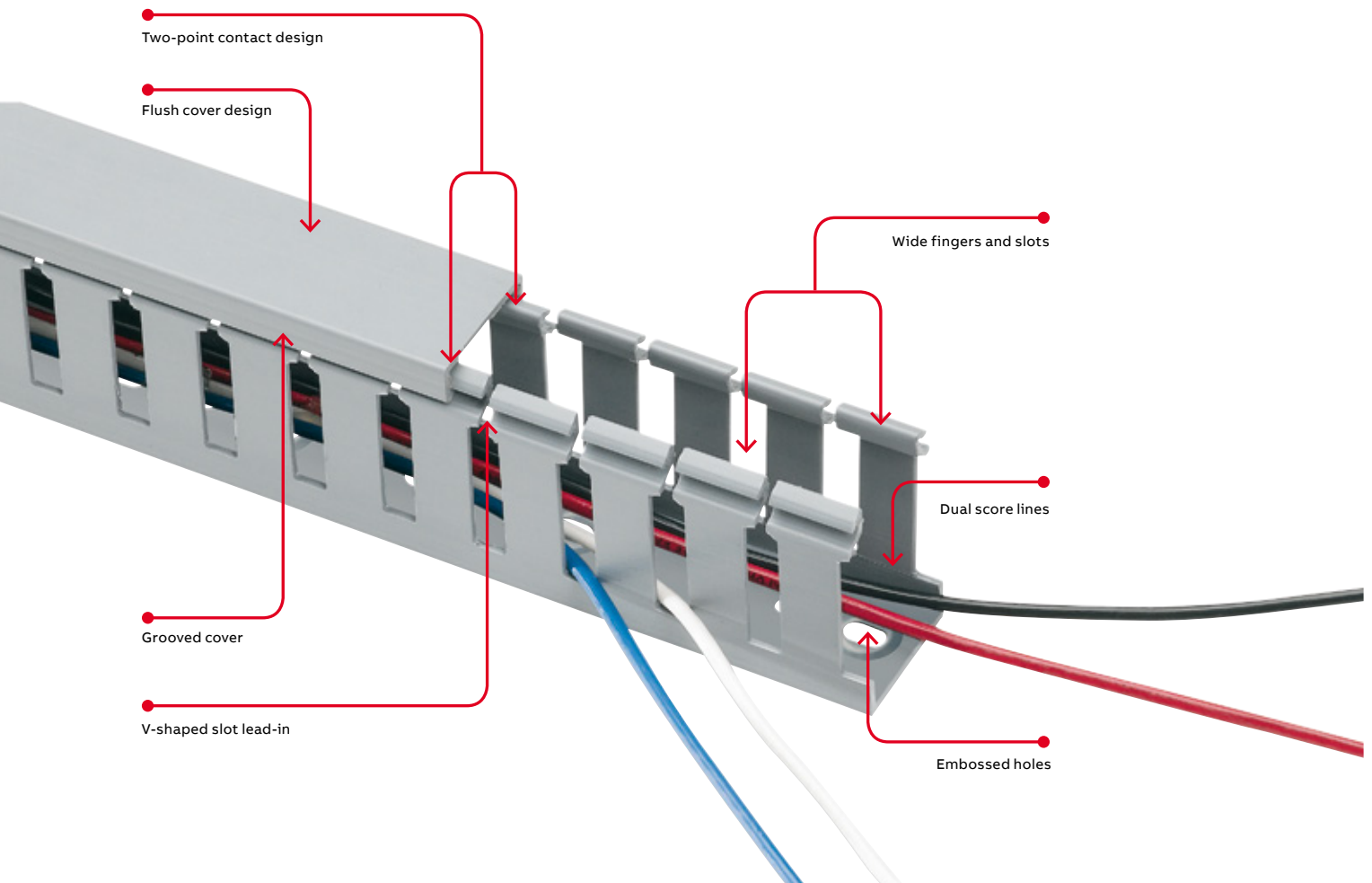

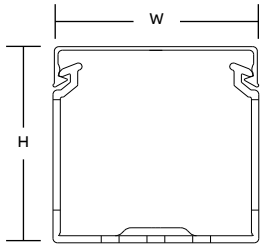

Front view with cover

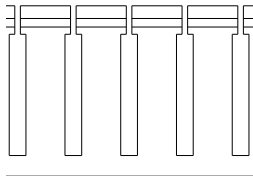

Side view

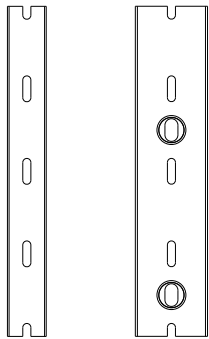

Pattern for 3/4" & 1"

Pattern for 1 1/2"

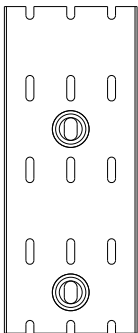

Pattern for 2", 2 1/2", 3", 4" & 6"

For a complete listing of wide slot dimensional details, see page 33.



Cat. no.	Description	Size (W x H)		Cover cat. no.	Duct std. ctn. qty.	Cover std. ctn. qty.	Length (ft.)
		in.	mm				
TYD75X1WP[_]6	0.75 x 1 Wide slot duct	0.94 x 1.14	23.9 x 27.7	TYD75CP[_]6	120	120	6
TYD75X15WP[_]6	0.75 x 1.5 Wide slot duct	0.94 x 1.60	23.9 x 39.6				
TYD75X2WP[_]6	0.75 x 2 Wide slot duct	0.94 x 2.10	23.9 x 52.6				
TYD1X1WP[_]6	1 x 1 Wide slot duct	1.25 x 1.14	31.8 x 27.7	TYD1CP[_]6	120	60	6
TYD1X15WP[_]6	1 x 1.5 Wide slot duct	1.25 x 1.60	31.8 x 39.9				
TYD1X2WP[_]6	1 x 2 Wide slot duct	1.25 x 2.10	31.8 x 52.8				
TYD1X3WP[_]6	1 x 3 Wide slot duct	1.25 x 3.05	31.8 x 77.7				
TYD1X4WP[_]6	1 x 4 Wide slot duct	1.25 x 4.37	31.8 x 111.3		60		
TYD15X1WP[_]6	1.5 x 1 Wide slot duct	1.75 x 1.14	44.5 x 27.7	TYD15CP[_]6	120	60	6
TYD15X15WP[_]6	1.5 x 1.5 Wide slot duct	1.75 x 1.60	44.5 x 39.9				
TYD15X2WP[_]6	1.5 x 2 Wide slot duct	1.75 x 2.10	44.5 x 52.8				
TYD15X3WP[_]6	1.5 x 3 Wide slot duct	1.75 x 3.05	44.5 x 77.7				
TYD15X4WP[_]6	1.5 x 4 Wide slot duct	1.75 x 4.37	44.5 x 111.3		60		
TYD2X1WP[_]6	2 x 1 Wide slot duct	2.25 x 1.24	57.2 x 28.4	TYD2CP[_]6	120	60	6
TYD2X15WP[_]6	2 x 1.5 Wide slot duct	2.25 x 1.70	57.2 x 40.4				
TYD2X2WP[_]6	2 x 2 Wide slot duct	2.25 x 2.19	57.2 x 53.3				
TYD2X3WP[_]6	2 x 3 Wide slot duct	2.25 x 3.14	57.2 x 78.2		60		
TYD2X4WP[_]6	2 x 4 Wide slot duct	2.25 x 4.46	57.2 x 111.8				
TYD2X5WP[_]6	2 x 5 Wide slot duct	2.25 x 5.15	57.2 x 129.3				
TYD25X2WP[_]6	2.5 x 2 Wide slot duct	2.75 x 2.19	69.9 x 53.6	TYD25CP[_]6	120	60	6
TYD25X3WP[_]6	2.5 x 3 Wide slot duct	2.75 x 3.14	69.9 x 78.2		60		
TYD25X4WP[_]6	2.5 x 4 Wide slot duct	2.75 x 4.46	69.9 x 111.8				
TYD3X1WP[_]6	3 x 1 Wide slot duct	3.25 x 1.24	82.6 x 29.0	TYD3CP[_]6	120	60	6
TYD3X2WP[_]6	3 x 2 Wide slot duct	3.25 x 2.19	82.6 x 54.9		60		
TYD3X3WP[_]6	3 x 3 Wide slot duct	3.25 x 3.14	82.6 x 79.8				
TYD3X4WP[_]6	3 x 4 Wide slot duct	3.25 x 4.46	82.6 x 113.5				
TYD3X5WP[_]6	3 x 5 Wide slot duct	3.25 x 5.15	82.6 x 130.6				
TYD4X15WP[_]6	4 x 1.5 Wide slot duct	4.25 x 1.70	108.0 x 42.4	TYD4CP[_]6	60	30	6
TYD4X2WP[_]6	4 x 2 Wide slot duct	4.25 x 2.19	108.0 x 55.1				
TYD4X3WP[_]6	4 x 3 Wide slot duct	4.25 x 3.14	108.0 x 80.0				
TYD4X4WP[_]6	4 x 4 Wide slot duct	4.25 x 4.46	108.0 x 113.8		30		
TYD4X5WP[_]6	4 x 5 Wide slot duct	4.25 x 5.15	108.0 x 130.8				
TYD6X4WP[_]6	6 x 4 Wide slot duct	6.25 x 4.46	158.8 x 114.0	TYD6CP[_]6	30	30	6

[] = space for color identifier:

G = Gray



W = White



B = Black



I = Intrinsic blue



• Standard lengths are 6 feet.

+ Catalog number must be completed by adding suffix G for gray, W for white, I for intrinsic blue, B for black.

Example: TYD75X1WPG6 is a 0.75" x 1" wide slot gray duct.

To order duct without mounting holes, add suffix NM to catalog number. Example: TYD75X1WPGNM6 is a 0.75" x 1" wide slot gray duct with no mounting holes.

To order adhesive-backed duct, add suffix A to catalog number.

Example: TYD75X1WPGA6 is a 0.75" x 1" wide slot gray duct with adhesive backing. Shelf life for adhesive is 1 year.

PVC vinyl duct is CSA certified, UL recognized and CE compliant.

Product ordering and information

Narrow slot wiring duct

Designed to fit the spacing of high-density terminal blocks.

Narrow slot wiring duct — PVC

- Higher number of smaller fingers for more concise harnessing
- Non-slip cover does not slide easily and resists vibration
- Rounded edges protect hands and wires
- V-shaped slot lead-in enables easier and faster wire installation
- Restricted slot design makes sure that wires are held with or without the cover inserted
- Cover attaches flush with sidewall for finished look
- Dual score lines are designed to yield clean breakoffs at the base of the slot and the duct
- Finger design restricts wire from slipping along the edge; creates two or three levels of wire service (see page 34 for illustration)
- Integrated mounting holes — larger sizes include staggered holes for mounting flexibility (see page 34 for illustration)
- Constructed of flame-retardant PVC
- Lead-free construction

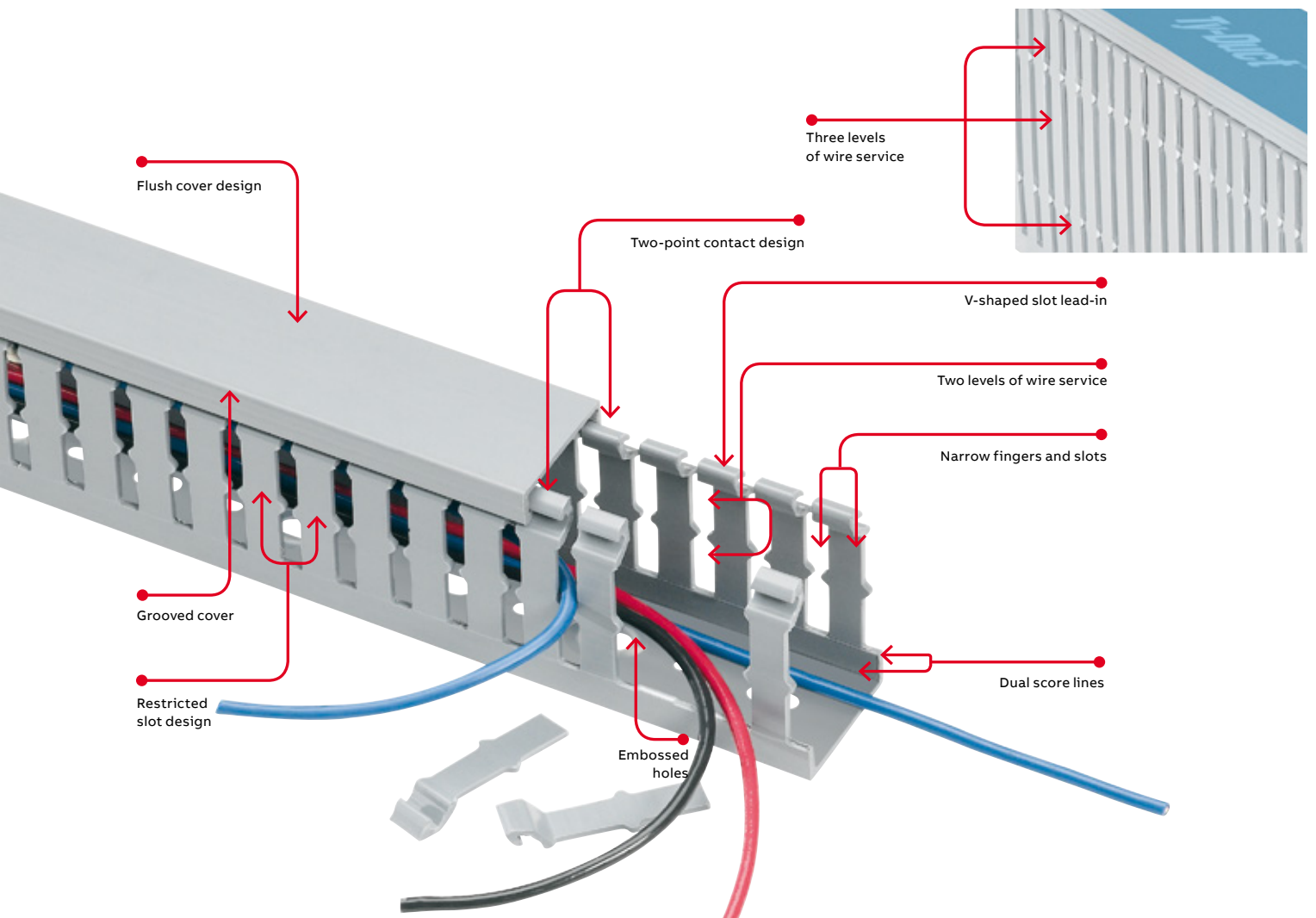

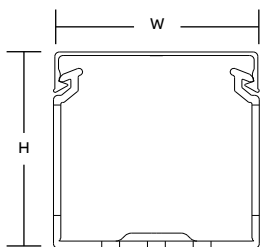

Front view with cover

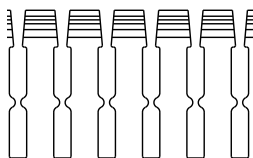

Side view

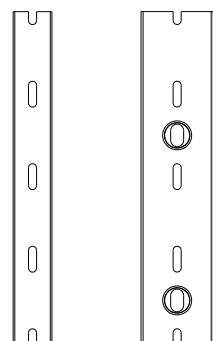

Pattern for 3/4" & 1"

Pattern for 1 1/2"

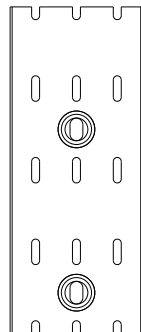

Pattern for 2", 2 1/2", 3", 4" & 6"

For a complete listing of narrow slot dimensional details, see page 34.



Cat. no.	Description (in.)	Size (W x H)		Cover cat. no.	Duct std. ctn. qty.	Cover std. ctn. qty.	Length (ft.)
		in.	mm				
TYD75X15NP[_]6	0.75 x 1.5 Narrow slot duct	0.94 x 1.60	23.9 x 39.6	TYD75CP[_]6	120	120	6
TYD1X1NP[_]6	1 x 1 Narrow slot duct	1.25 x 1.14	31.8 x 27.7	TYD1CP[_]6	120	60	6
TYD1X15NP[_]6	1 x 1.5 Narrow slot duct	1.25 x 1.60	31.8 x 39.9				
TYD1X2NP[_]6	1 x 2 Narrow slot duct	1.25 x 2.10	31.8 x 52.8				
TYD1X3NP[_]6	1 x 3 Narrow slot duct	1.25 x 3.05	31.8 x 77.7				
TYD1X4NP[_]6	1 x 4 Narrow slot duct	1.25 x 4.37	31.8 x 111.3		60		
TYD15X1NP[_]6	1.5 x 1 Narrow slot duct	1.75 x 1.14	44.5 x 27.7	TYD15CP[_]6	120	60	6
TYD15X15NP[_]6	1.5 x 1.5 Narrow slot duct	1.75 x 1.60	44.5 x 39.9				
TYD15X2NP[_]6	1.5 x 2 Narrow slot duct	1.75 x 2.10	44.5 x 52.8				
TYD15X3NP[_]6	1.5 x 3 Narrow slot duct	1.75 x 3.05	44.5 x 77.7				
TYD15X4NP[_]6	1.5 x 4 Narrow slot duct	1.75 x 4.37	44.5 x 111.3		60		
TYD2X1NP[_]6	2 x 1 Narrow slot duct	2.25 x 1.24	57.2 x 28.4	TYD2CP[_]6	120	60	6
TYD2X15NP[_]6	2 x 1.5 Narrow slot duct	2.25 x 1.70	57.2 x 40.4				
TYD2X2NP[_]6	2 x 2 Narrow slot duct	2.25 x 2.19	57.2 x 53.3				
TYD2X3NP[_]6	2 x 3 Narrow slot duct	2.25 x 3.14	57.2 x 78.2		60		
TYD2X4NP[_]6	2 x 4 Narrow slot duct	2.25 x 4.46	57.2 x 111.8				
TYD2X5NP[_]6	2 x 5 Narrow slot duct	2.25 x 5.15	57.2 x 129.3				
TYD25X2NP[_]6	2.5 x 2 Narrow slot duct	2.75 x 2.19	69.9 x 53.6	TYD25CP[_]6	120	60	6
TYD25X3NP[_]6	2.5 x 3 Narrow slot duct	2.75 x 3.14	69.9 x 78.2		60		
TYD25X4NP[_]6	2.5 x 4 Narrow slot duct	2.75 x 4.46	69.9 x 111.8				
TYD3X1NP[_]6	3 x 1 Narrow slot duct	3.25 x 1.24	82.6 x 29.0	TYD3CP[_]6	120	60	6
TYD3X2NP[_]6	3 x 2 Narrow slot duct	3.25 x 2.19	82.6 x 54.9		60		
TYD3X3NP[_]6	3 x 3 Narrow slot duct	3.25 x 3.14	82.6 x 79.8				
TYD3X4NP[_]6	3 x 4 Narrow slot duct	3.25 x 4.46	82.6 x 113.5				
TYD3X5NP[_]6	3 x 5 Narrow slot duct	3.25 x 5.15	82.6 x 130.6				
TYD4X2NP[_]6	4 x 2 Narrow slot duct	4.25 x 2.19	108.0 x 55.1	TYD4CP[_]6	60	30	6
TYD4X3NP[_]6	4 x 3 Narrow slot duct	4.25 x 3.14	108.0 x 80.0				
TYD4X4NP[_]6	4 x 4 Narrow slot duct	4.25 x 4.46	108.0 x 113.8		30		
TYD4X5NP[_]6	4 x 5 Narrow slot duct	4.25 x 5.15	108.0 x 130.8				

[] = space for color identifier:

- G = Gray
- W = White
- B = Black
- I = Intrinsic blue

- Standard lengths are 6 feet.
- + Catalog number must be completed by adding suffix G for gray, W for white, I for intrinsic blue, B for black.
- Example: TYD75X15NPG6 is a 0.75" x 1" wide slot gray duct.
- To order duct without mounting holes, add suffix NM to catalog number.
- Example: TYD75X15NPG6NM is a 0.75" x 1" wide slot gray duct with no mounting holes.
- To order adhesive-backed duct, add suffix A to catalog number.
- Example: TYD75X15NPG6A is a 0.75" x 1" wide slot gray duct with adhesive backing. Shelf life for adhesive is 1 year.
- PVC vinyl duct is CSA certified, UL recognized and CE compliant.

Product ordering and information

Round hole wiring duct

Holes retain and support wires at different heights.

Round hole wiring duct — PVC

- Multiple rows of holes retain wire at different heights and positions with or without the cover
- Features maximum number of wire holes
- Greater wall rigidity than open slot duct
- Non-slip cover does not slide easily and resists vibration
- Rounded edges protect hands and wires
- Base score line enables sidewall section to be removed
- Cover attaches flush with sidewall for finished look
- Constructed of flame-retardant PVC
- Integrated mounting holes — larger sizes include staggered holes for mounting flexibility (see page 35 for illustration)
- Lead-free construction

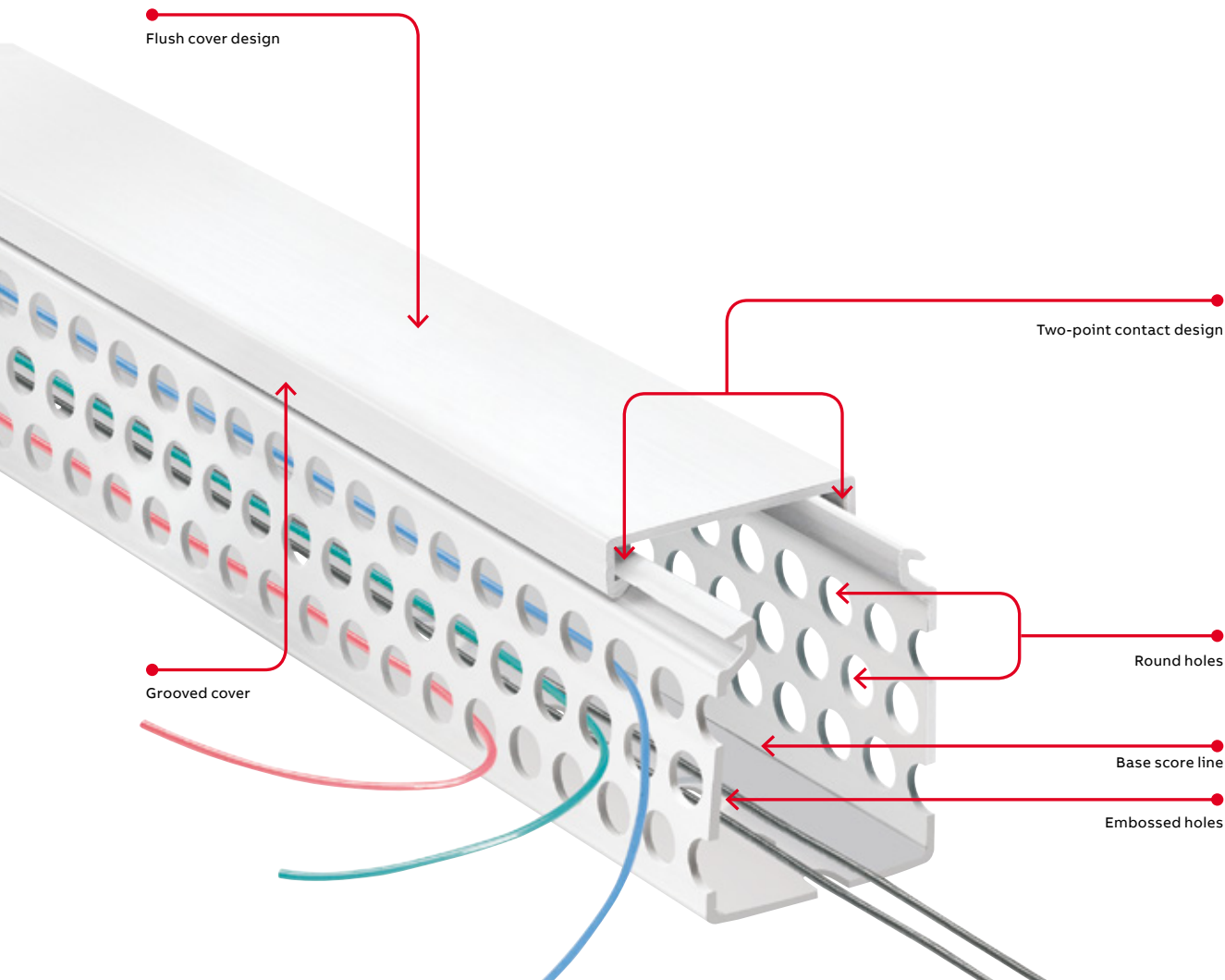

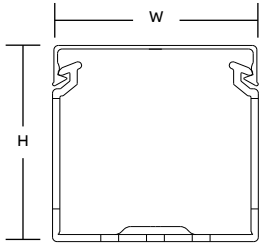

Front view with cover

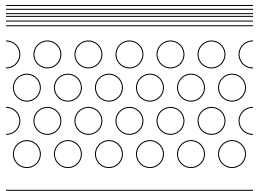

Side view

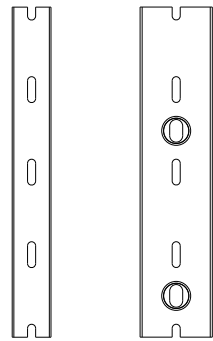

Pattern for 1/4" & 1"

Pattern for 1 1/2"

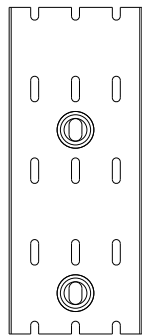

Pattern for 2", 2 1/2", 3", 4" & 6"

For a complete listing of round hole dimensional details, see page 35.



Cat. no.	Description (in.)	Size (W x H)		Cover cat. no.	Duct std. ctn. qty.	Cover std. ctn. qty.	Length (ft.)
		in.	mm				
TYD1X15RP[_]6	1 x 1.5 Round hole duct	1.75 x 1.60	44.5 x 39.9	TYD1CP[_]6	120	60	6
TYD1X2RP[_]6	1 x 2 Round hole duct	1.25 x 2.10	31.8 x 52.8				
TYD1X3RP[_]6	1 x 3 Round hole duct	1.25 x 3.05	31.8 x 77.7				
TYD1X4RP[_]6	1 x 4 Round hole duct	1.25 x 4.37	31.8 x 111.3		60		
TYD15X15RP[_]6	1.5 x 1.5 Round hole duct	1.75 x 1.60	44.5 x 39.9	TYD15CP[_]6	120	60	6
TYD15X2RP[_]6	1.5 x 2 Round hole duct	1.75 x 2.10	44.5 x 52.8				
TYD15X3RP[_]6	1.5 x 3 Round hole duct	1.75 x 3.05	44.5 x 77.7				
TYD15X4RP[_]6	1.5 x 4 Round hole duct	1.75 x 4.37	44.5 x 111.3		60		
TYD2X15RP[_]6	2 x 1.5 Round hole duct	2.25 x 1.70	57.2 x 40.4	TYD2CP[_]6	120	60	6
TYD2X2RP[_]6	2 x 2 Round hole duct	2.25 x 2.19	57.2 x 53.3				
TYD2X3RP[_]6	2 x 3 Round hole duct	2.25 x 3.14	57.2 x 78.2		60		
TYD2X4RP[_]6	2 x 4 Round hole duct	2.25 x 4.46	57.2 x 111.8				
TYD3X2RP[_]6	3 x 2 Round hole duct	3.25 x 2.19	82.6 x 54.9	TYD3CP[_]6	60	60	6
TYD3X3RP[_]6	3 x 3 Round hole duct	3.25 x 3.14	82.6 x 79.8				
TYD3X4RP[_]6	3 x 4 Round hole duct	3.25 x 4.46	82.6 x 113.5				
TYD4X15RP[_]6	4 x 1.5 Round hole duct	4.25 x 1.70	108.0 x 42.4	TYD4CP[_]6	60	30	6
TYD4X2RP[_]6	4 x 2 Round hole duct	4.25 x 2.19	108.0 x 55.1				
TYD4X3RP[_]6	4 x 3 Round hole duct	4.25 x 3.14	108.0 x 80.0				
TYD4X4RP[_]6	4 x 4 Round hole duct	4.25 x 4.46	108.0 x 113.8		30		

[] = space for color identifier:

G = Gray



W = White



B = Black



I = Intrinsic blue



* Standard lengths are 6 feet.

+ Catalog number must be completed by adding suffix G for gray, W for white, I for intrinsic blue, B for black.

Example: TYD1X15RPG6 is a 1" x 1.5" round hole gray duct.

To order duct without mounting holes, add suffix NM to catalog number.

Example: TYD1X15RPG6NM is a 1" x 1.5" round hole gray duct with no mounting holes.

To order adhesive-backed duct, add suffix A to catalog number.

Example: TYD1X15RPG6A is a 1" x 1.5" round hole gray duct with adhesive backing.

PVC vinyl duct is CSA certified, UL recognized and CE compliant.

Product ordering and information

Metric wide and narrow slot wiring duct

Lead-free thermoplastic duct

With 8–12 / 4–6 mm slots

- Shock-resistant and self-extinguishing thermoplastic in conformity with UL94V-0 standard, resistant to abnormal heat and fire up to 960 °C (glow-wire test) in conformity with IEC 60695-2-1 standard
- Minimum storage/transport temperature -5 °C
- Minimum installation/use temperature -15 °C
- DIN standard mounting holes (refer to page 36–37 for illustration)
- Maximum use temperature 60 °C
- Standard length 2 meters
- Color RAL 7030 gray
- Conforms to EN 50085-2-3 standard
- Conforms to RoHS directive
- Lead-free
- Certifications: CSA – File no. 077988, IMQ, UL, RINA

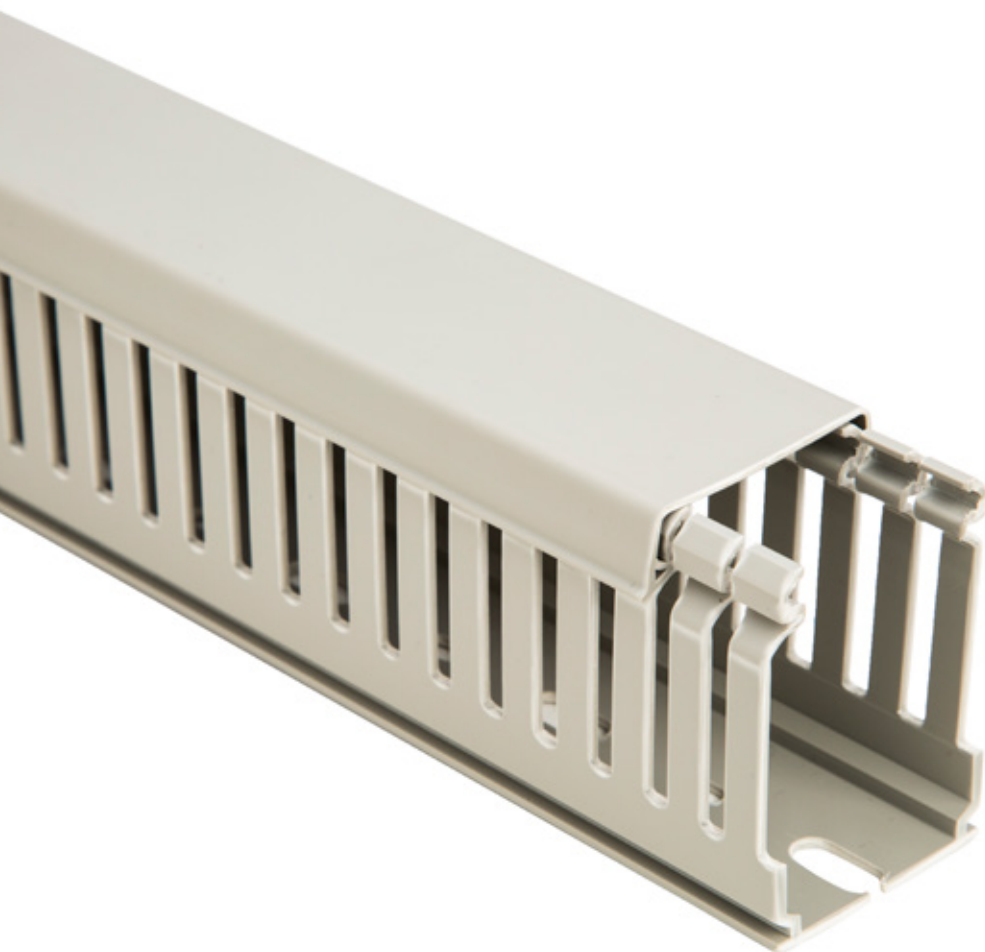

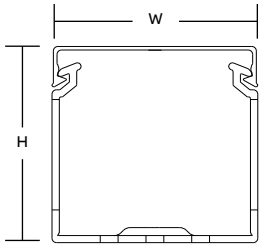

Front view with cover

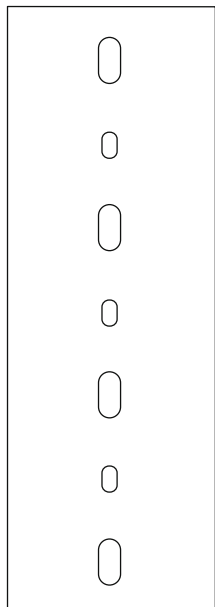

Bottom view

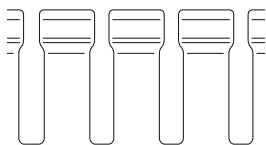

Side view

Wide slot wiring duct

For a complete listing of wide slot dimensional details, see page 36.

Cat. no.	Description (mm)	Size (W x H)		Cover cat. no.*	Duct std. ctn. qty. (meters)	Length (meters)
		in.	mm			
05019	15 x 17 Gray wide finger wiring duct	0.59 x 0.67	15 x 17	05300	46	2
05033	25 x 30 Gray wide finger wiring duct	0.98 x 1.18	25 x 30	05302	58	2
05035	40 x 30 Gray wide finger wiring duct	1.57 x 1.18	40 x 30	05304	38	2
05037	60 x 30 Gray wide finger wiring duct	2.36 x 1.18	60 x 30	05306	52	2
05043	25 x 40 Gray wide finger wiring duct	0.98 x 1.57	25 x 40	05302	48	2
05045	40 x 40 Gray wide finger wiring duct	1.57 x 1.57	40 x 40	05304	30	2
05047	60 x 40 Gray wide finger wiring duct	2.36 x 1.57	60 x 40	05306	40	2
05049	80 x 40 Gray wide finger wiring duct	3.15 x 1.57	80 x 40	05308	32	2
05051	100 x 40 Gray wide finger wiring duct	3.94 x 1.57	100 x 40	05310	24	2
05053	120 x 40 Gray wide finger wiring duct	4.72 x 1.57	120 x 40	05312	20	2
05063	25 x 60 Gray wide finger wiring duct	0.98 x 2.36	25 x 60	05302	34	2
05065	40 x 60 Gray wide finger wiring duct	1.57 x 2.36	40 x 60	05304	22	2
05067	60 x 60 Gray wide finger wiring duct	2.36 x 2.36	60 x 60	05306	32	2
05069	80 x 60 Gray wide finger wiring duct	3.15 x 2.36	80 x 60	05308	24	2
05071	100 x 60 Gray wide finger wiring duct	3.94 x 2.36	100 x 60	05310	20	2
05073	120 x 60 Gray wide finger wiring duct	4.72 x 2.36	120 x 60	05312	14	2
05083	25 x 80 Gray wide finger wiring duct	0.98 x 3.15	25 x 80	05302	28	2
05085	40 x 80 Gray wide finger wiring duct	1.57 x 3.15	40 x 80	05304	36	2
05087	60 x 80 Gray wide finger wiring duct	2.36 x 3.15	60 x 80	05306	24	2
05089	80 x 80 Gray wide finger wiring duct	3.15 x 3.15	80 x 80	05308	16	2
05091	100 x 80 Gray wide finger wiring duct	3.94 x 3.15	100 x 80	05310	16	2
05093	120 x 80 Gray wide finger wiring duct	4.72 x 3.15	120 x 80	05312	12	2
05094	25 x 100 Gray wide finger wiring duct	0.98 x 3.94	25 x 100	05302	20	2
05095	40 x 100 Gray wide finger wiring duct	1.57 x 3.94	40 x 100	05304	28	2
05096	60 x 100 Gray wide finger wiring duct	2.36 x 3.94	60 x 100	05306	20	2
05097	80 x 100 Gray wide finger wiring duct	3.15 x 3.94	80 x 100	05308	14	2
05098	100 x 100 Gray wide finger wiring duct	3.94 x 3.94	100 x 100	05310	8	2
05099	150 x 100 Gray wide finger wiring duct	5.91 x 3.94	150 x 100	05314	8	2

*Covers are included with all duct orders.

Product ordering and information

Metric wide and narrow slot wiring duct

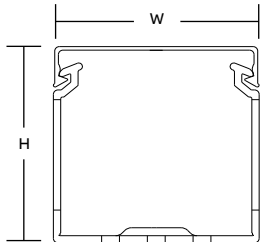

Front view with cover

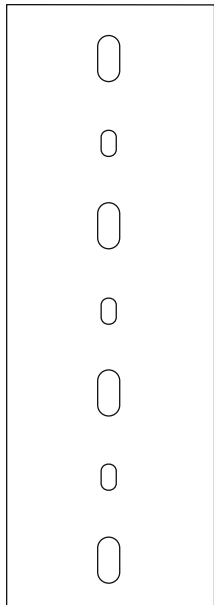

Bottom view

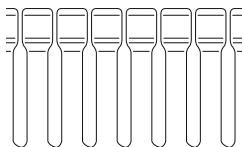

Side view

Narrow slot wiring duct

For a complete listing of narrow slot dimensional details, see page 37.

Cat. no.	Description (mm)	Size (W x H)		Cover cat. no.*	Duct std. ctn. qty. (meters)	Length (meters)
		in.	mm			
05119	15 x 17 Gray narrow finger wiring duct	0.59 x 0.67	15 x 17	05300	46	2
05133	25 x 30 Gray narrow finger wiring duct	0.98 x 1.18	25 x 30	05302	58	2
05135	40 x 30 Gray narrow finger wiring duct	1.57 x 1.18	40 x 30	05304	38	2
05137	60 x 30 Gray narrow finger wiring duct	2.36 x 1.18	60 x 30	05306	52	2
05143	25 x 40 Gray narrow finger wiring duct	0.98 x 1.57	25 x 40	05302	48	2
05145	40 x 40 Gray narrow finger wiring duct	1.57 x 1.57	40 x 40	05304	30	2
05147	60 x 40 Gray narrow finger wiring duct	2.36 x 1.57	60 x 40	05306	40	2
05149	80 x 40 Gray narrow finger wiring duct	3.15 x 1.57	80 x 40	05308	32	2
05151	100 x 40 Gray narrow finger wiring duct	3.94 x 1.57	100 x 40	05310	24	2
05153	120 x 40 Gray narrow finger wiring duct	4.72 x 1.57	120 x 40	05312	20	2
05163	25 x 60 Gray narrow finger wiring duct	0.98 x 2.36	25 x 60	05302	34	2
05165	40 x 60 Gray narrow finger wiring duct	1.57 x 2.36	40 x 60	05304	22	2
05167	60 x 60 Gray narrow finger wiring duct	2.36 x 2.36	60 x 60	05306	32	2
05169	80 x 60 Gray narrow finger wiring duct	3.15 x 2.36	80 x 60	05308	24	2
05171	100 x 60 Gray narrow finger wiring duct	3.94 x 2.36	100 x 60	05310	20	2
05173	120 x 60 Gray narrow finger wiring duct	4.72 x 2.36	120 x 60	05312	14	2
05183	25 x 80 Gray narrow finger wiring duct	0.98 x 3.15	25 x 80	05302	28	2
05185	40 x 80 Gray narrow finger wiring duct	1.57 x 3.15	40 x 80	05304	36	2
05187	60 x 80 Gray narrow finger wiring duct	2.36 x 3.15	60 x 80	05306	24	2
05189	80 x 80 Gray narrow finger wiring duct	3.15 x 3.15	80 x 80	05308	16	2
05191	100 x 80 Gray narrow finger wiring duct	3.94 x 3.15	100 x 80	05310	16	2
05193	120 x 80 Gray narrow finger wiring duct	4.72 x 3.15	120 x 80	05312	12	2
05194	25 x 100 Gray narrow finger wiring duct	0.98 x 3.94	25 x 100	05302	20	2
05195	40 x 100 Gray narrow finger wiring duct	1.57 x 3.94	40 x 100	05304	28	2
05196	60 x 100 Gray narrow finger wiring duct	2.36 x 3.94	60 x 100	05306	20	2
05197	80 x 100 Gray narrow finger wiring duct	3.15 x 3.94	80 x 100	05308	14	2
05198	100 x 100 Gray narrow finger wiring duct	3.94 x 3.94	100 x 100	05310	8	2
05199	150 x 100 Gray narrow finger wiring duct	5.91 x 3.94	150 x 100	05314	8	2

*Covers are included with all duct orders.

Replacement covers for wiring duct

Cat. no.	Description	Size (mm)	Length / pack qty. (meters)
05300	15 mm wiring duct cover	15	2 / 200
05302	25 mm wiring duct cover	25	2 / 60
05304	40 mm wiring duct cover	40	2 / 40
05306	60 mm wiring duct cover	60	2 / 24
05308	80 mm wiring duct cover	80	2 / 16
05310	100 mm wiring duct cover	100	2 / 48
05312	120 mm wiring duct cover	120	2 / 36
05314	150 mm wiring duct cover	150	2 / 28

Product ordering and information

Metric halogen-free wide and narrow slot wiring duct

Metric halogen-free thermoplastic duct

With 8–12 / 4–6 mm slots

- Halogen-free thermoplastic in conformity with VDE 0472 standard Part 815: Br + Cl < 0.2 %, F < 0.1 %
- Toxic smoke index: 25.78 in conformity with NF X70-100 and NF F16-101 standards
- Opacity of smoke*:
Dm 352.2 (2 mm)
VOF4 475.8 (2 mm) in conformity with NF X10-702 standard (NF F16-101 reference)
- Based on the values obtained in the opacity and toxicity tests of smoke, the material belongs to class F2 (in conformity with NF F16-101 standard)
- Insulating, shock-resistant and self-extinguishing thermoplastic in conformity with UL94V-0 standard, resistant to abnormal heat and fire up to 850 °C (glow-wire test) in conformity with IEC 60695-2-1 standard
- Dimensional stability from -40 °C to 100 °C
- Standard length 2 meters
- Color RAL 7035 gray
- Conforms to EN 50085-2-3 standard
- Conforms to RoHS directive
- Certification: UL, cULus

* Reduced smoke opacity during the first 4 minutes of a fire facilitates evacuation from areas of risk.



Product ordering and information

Metric halogen-free wide and narrow slot wiring duct

—
Metric halogen-free wide slot wiring duct

For a complete listing of wide slot dimensional details, see page 36.

Cat. no.*	Description (mm)	Size (W x H)		Cover cat. no.*	Duct std. ctn. qty. (meters)	Length (meters)
		in.	mm			
1SL9019A00	15 x 17 Halogen-free wide finger duct	0.59 x 0.67	15 x 17	1SL5316A00	46	2
1SL9033A00	25 x 30 Halogen-free wide finger duct	0.98 x 1.18	25 x 30	1SL5317A00	58	2
1SL9043A00	25 x 40 Halogen-free wide finger duct	0.98 x 1.57	25 x 40	1SL5317A00	48	2
1SL9063A00	25 x 60 Halogen-free wide finger duct	0.98 x 2.36	25 x 60	1SL5317A00	34	2
1SL9083A00	25 x 80 Halogen-free wide finger duct	0.98 x 3.15	25 x 80	1SL5317A00	28	2
1SL9035A00	40 x 30 Halogen-free wide finger duct	1.57 x 1.18	40 x 30	1SL5318A00	40	2
1SL9045A00	40 x 40 Halogen-free wide finger duct	1.57 x 1.57	40 x 40	1SL5318A00	30	2
1SL9065A00	40 x 60 Halogen-free wide finger duct	1.57 x 2.36	40 x 60	1SL5318A00	22	2
1SL9085A00	40 x 80 Halogen-free wide finger duct	1.57 x 3.15	40 x 80	1SL5318A00	36	2
1SL9095A00	40 x 100 Halogen-free wide finger duct	1.57 x 3.94	40 x 100	1SL5318A00	28	2
1SL9037A00	60 x 30 Halogen-free wide finger duct	2.36 x 1.18	60 x 30	1SL5319A00	52	2
1SL9047A00	60 x 40 Halogen-free wide finger duct	2.36 x 1.57	60 x 40	1SL5319A00	40	2
1SL9067A00	60 x 60 Halogen-free wide finger duct	2.36 x 2.36	60 x 60	1SL5319A00	32	2
1SL9087A00	60 x 80 Halogen-free wide finger duct	2.36 x 3.15	60 x 80	1SL5319A00	24	2
1SL9096A00	60 x 100 Halogen-free wide finger duct	2.36 x 3.94	60 x 100	1SL5319A00	20	2
1SL9049A00	80 x 40 Halogen-free wide finger duct	3.15 x 1.57	80 x 40	1SL5320A00	32	2
1SL9069A00	80 x 60 Halogen-free wide finger duct	3.15 x 2.36	80 x 60	1SL5320A00	24	2
1SL9089A00	80 x 80 Halogen-free wide finger duct	3.15 x 3.15	80 x 80	1SL5320A00	16	2
1SL9097A00	80 x 100 Halogen-free wide finger duct	3.15 x 3.94	80 x 100	1SL5320A00	14	2
1SL9051A00	100 x 40 Halogen-free wide finger duct	3.94 x 1.57	100 x 40	1SL5321A00	24	2
1SL9071A00	100 x 60 Halogen-free wide finger duct	3.94 x 2.36	100 x 60	1SL5321A00	20	2
1SL9091A00	100 x 80 Halogen-free wide finger duct	3.94 x 3.15	100 x 80	1SL5321A00	16	2
1SL9098A00	100 x 100 Halogen-free wide finger duct	3.94 x 3.94	100 x 100	1SL5321A00	8	2
1SL9053A00	120 x 40 Halogen-free wide finger duct	4.72 x 1.57	120 x 40	1SL5322A00	20	2
1SL9073A00	120 x 60 Halogen-free wide finger duct	4.72 x 2.36	120 x 60	1SL5322A00	14	2
1SL9093A00	120 x 80 Halogen-free wide finger duct	4.72 x 3.15	120 x 80	1SL5322A00	12	2

*Covers are included with all duct orders.

Contact local sales office for pricing and delivery information.

Product ordering and information

Halogen-free wide and narrow slot wiring duct

Metric halogen-free narrow slot wiring duct

For a complete listing of narrow slot dimensional details, see page 37.

Cat. no.*	Description	Size (W x H)		Cover cat. no.*	Duct std. ctn. qty. (meters)	Length (meters)
		in.	mm			
1SL9119A00	15 x 17 Halogen-free narrow finger duct	0.59 x 0.67	15 x 17	1SL5316A00	46	2
1SL9133A00	25 x 30 Halogen-free narrow finger duct	0.98 x 1.18	25 x 30	1SL5317A00	58	2
1SL9143A00	25 x 40 Halogen-free narrow finger duct	0.98 x 1.57	25 x 40	1SL5317A00	40	2
1SL9163A00	25 x 60 Halogen-free narrow finger duct	0.98 x 2.36	25 x 60	1SL5317A00	52	2
1SL9183A00	25 x 80 Halogen-free narrow finger duct	0.98 x 3.15	25 x 80	1SL5317A00	48	2
1SL9135A00	40 x 30 Halogen-free narrow finger duct	1.57 x 1.18	40 x 30	1SL5318A00	30	2
1SL9145A00	40 x 40 Halogen-free narrow finger duct	1.57 x 1.57	40 x 40	1SL5318A00	40	2
1SL9165A00	40 x 60 Halogen-free narrow finger duct	1.57 x 2.36	40 x 60	1SL5318A00	32	2
1SL9185A00	40 x 80 Halogen-free narrow finger duct	1.57 x 3.15	40 x 80	1SL5318A00	24	2
1SL9137A00	60 x 30 Halogen-free narrow finger duct	2.36 x 1.18	60 x 30	1SL5319A00	20	2
1SL9147A00	60 x 40 Halogen-free narrow finger duct	2.36 x 1.57	60 x 40	1SL5319A00	34	2
1SL9167A00	60 x 60 Halogen-free narrow finger duct	2.36 x 2.36	60 x 60	1SL5319A00	22	2
1SL9187A00	60 x 80 Halogen-free narrow finger duct	2.36 x 3.15	60 x 80	1SL5319A00	32	2
1SL9149A00	80 x 40 Halogen-free narrow finger duct	3.15 x 1.57	80 x 40	1SL5320A00	24	2
1SL9169A00	80 x 60 Halogen-free narrow finger duct	3.15 x 2.36	80 x 60	1SL5320A00	20	2
1SL9189A00	80 x 80 Halogen-free narrow finger duct	3.15 x 3.15	80 x 80	1SL5320A00	14	2
1SL9151A00	100 x 40 Halogen-free narrow finger duct	3.94 x 1.57	100 x 40	1SL5321A00	28	2
1SL9171A00	100 x 60 Halogen-free narrow finger duct	3.94 x 2.36	100 x 60	1SL5321A00	36	2
1SL9191A00	100 x 80 Halogen-free narrow finger duct	3.94 x 3.15	100 x 80	1SL5321A00	24	2
1SL9153A00	120 x 40 Halogen-free narrow finger duct	4.72 x 1.57	120 x 40	1SL5322A00	16	2
1SL9173A00	120 x 60 Halogen-free narrow finger duct	4.72 x 2.36	120 x 60	1SL5322A00	16	2
1SL9193A00	120 x 80 Halogen-free narrow finger duct	4.72 x 3.15	120 x 80	1SL5322A00	12	2

*Covers are included with all duct orders.

Replacement covers for metric halogen-free wiring duct

Cat. no.	Description	Size (mm)	Length / pack qty. (meters)
1SL5316A00	15 mm wiring duct cover	15	2 / 200
1SL5317A00	25 mm wiring duct cover	25	2 / 60
1SL5318A00	40 mm wiring duct cover	40	2 / 40
1SL5319A00	60 mm wiring duct cover	60	2 / 24
1SL5320A00	80 mm wiring duct cover	80	2 / 16
1SL5321A00	100 mm wiring duct cover	100	2 / 48
1SL5322A00	120 mm wiring duct cover	120	2 / 36

Product ordering and information

Accessories

Trust ABB for all your wiring accessories

Accessories include:

- Divider walls, enabling multiple channels to be created within a duct channel
- Universal mounting clips that secure channels and wires
- Corner strips that keep corners rigid at tee junctions when used for control panel applications
- Joining strips to unite sections of duct and keep the wall rigid
- Plastic rivets for securing ducts quickly and easily



= space for color identifier:

G = Gray



W = White



B = Black



I = Intrinsic blue



Divider wall

Create multiple channels inside wiring ducts.

- Separates high and low voltage to reduce shortages and interference
- Mount inside any Ty-Duct PVC wiring duct using universal mounting clips
- Score lines enable sections to be removed
- Solid and wide slotted style

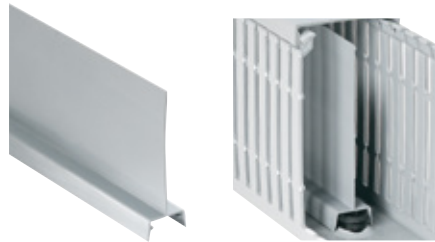

Cat. no.	Description	Length (ft.)	Std. ctn. qty.
TY1D[][]6	1" High wall divider	6	120
TY1.5D[][]6	1.5" High wall divider	6	120
TY2D[][]6	2" High wall divider	6	120
TY3D[][]6	3" High wall divider	6	120
TY4D[][]6	4" High wall divider	6	120
TY5D[][]6	5" High wall divider	6	120

+ Catalog number must be completed by adding suffix SP for solid or WP for wide slot.
 Example: TY2DSPG6 is a 2" high solid wall gray divider.

Universal mounting clips

One size fits all.

- Added before or after the duct is in place, without additional hardware
- Twists into place — holds securely
- Installs easily using a screwdriver
- Accommodates up to 40 lb. cable ties
- Black polycarbonate construction



Cat. no.	Description	Qty.
UMC	Universal fastener mount	100 pk

Corner strips

Install smooth round corners on your wiring duct.

- Constructed of rigid PVC
- One-piece design makes installation a snap
- Works with any Ty-Duct wiring duct
- Select from a variety of sizes



Cat. no.	Description	Length (ft.)	Std. ctn. qty.
TYCS[_]6	Corner strip	6	120

+ Catalog number must be completed by adding suffix G for gray, W for white, I for intrinsic blue, B for black.
 Example: TYCSG6 is a gray corner strip.

Joining strips

Join duct sections easily.

- Slides on duct
- Constructed of rigid PVC
- One-piece design makes installation easy
- Works with any Ty-Duct wiring duct



Cat. no.	Description	Length (ft.)	Std. ctn. qty.
TYJC[_]6	Joining strip	6	120

+ Catalog number must be completed by adding suffix G for gray, W for white, I for intrinsic blue, B for black.
 Example: TYJCG6 is a gray joining strip.

Plastic rivets

Plastic rivets make mounting ducts easy.

- Fast installation
- Durable and economical
- One size

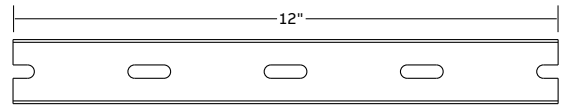

Minimum mounting rivet distance for ducts of 0.75" and 1" wide.

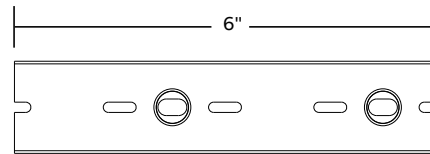

Minimum mounting rivet distance for ducts 1.5" wide.

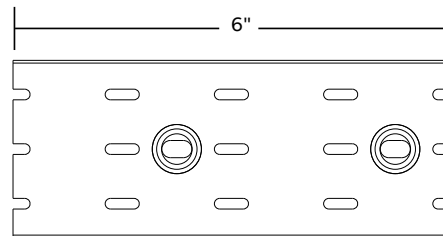

Minimum mounting rivet distance for ducts greater than 1.5" wide. Installed top and bottom.

Cat. no.	Description	Qty.
08200C	3/16" Plastic rivet	100 pk

Product ordering and information

Accessories

Wire retainer

Holds wires in place for faster, easier installation and routing.

- One size fits all
- Comes in gray and clear plastic to blend with any duct color
- Size is 2.5"L and 0.281" x 0.18"



Cat. no.	Description	Qty.
TYWRC	Wire retainer, clear	100
TYWRG	Wire retainer, gray	100

Mounting clips

Ideal for high-temperature environments.

- Speeds duct mounting
- Enables duct removal
- Provides a stand-off between panel and duct to prevent direct heat transfer — ideal for high temperature environments

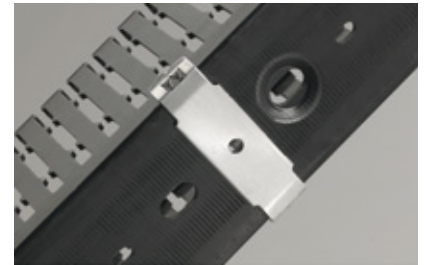

Cat. no.	Width (in.)	Std. ctn. qty.
TY1MC	1	100
TY15MC	1.5	100
TY2MC	2	100
TY3MC	3	100

All are 0.75" D x 0.35" H and made of Type 316 stainless steel.

Product ordering and information

Tools

The wiring duct tools you need for every application.

Tools include:

- Duct cutting tools for a clean professional finish
- Finger cutting tools that make modifications simple
- Notching tools for duct sidewalls to facilitate tee and corner junctions
- Benchmount cutting tools for fast, high volume duct cutting
- Rivet installation tools for quick duct mounting



Duct/cover cutting tool

Lightweight and durable.

- All-steel construction
- Sharp cutting surface
- Replaceable blades available
- Improved performance

Cat. no.	Description
SX-25TB	Handheld duct cutter — long

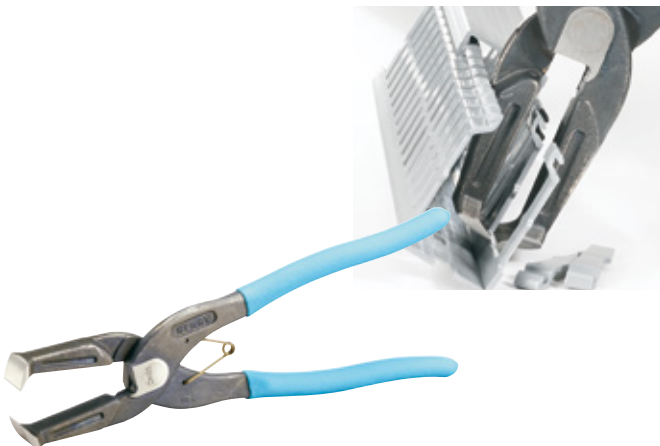

Finger cutting tool

Cut duct fingers easily.

- Rugged die-cast construction with insulated handles for a comfortable, non-slip grip
- Removes duct fingers in tight places
- Works with all slotted wiring duct
- Also cuts round and solid wall duct
- Spring loaded

Cat. no.	Description
DK-65TB	Duct finger cutter

Product ordering and information

Tools



Bench-mount cutting tool

For fast, high volume duct cutting.

- Engineered for use with Ty-Duct plastic wiring ducts and covers
- All-steel construction lasts for years
- Adjustable gauge sets the desired length of duct
- Easy-to-read measuring indicator
- Adjustable stop for easy repeated cutting

Cat. no.	Description
DC-125TB	Bench-mount duct cutter

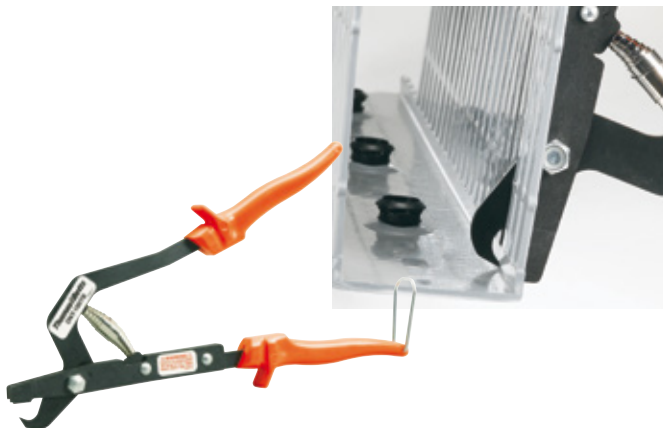

Notching tool

Notch duct sidewalls fast.

- Notches sidewalls to bottom scoreline
- Facilitates tee and corner junctions
- Rugged design
- Easy to use
- Spring loaded

Cat. no.	Description
DNT-100TB	Duct notching tool

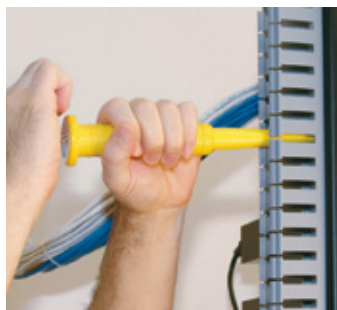

Rivet installation tool

Mount ducts quickly.

- Use for setting duct rivets
- Pressure on the tool head secures the rivet in place

For duct rivets, see page 25.



Cat. no.	Description
08205	08200 Series rivet installation tool

For any inquiries, please contact your ABB sales representative.

Appendix

030–031	Technical information
032–037	Dimensional information
038	Industry standards and certifications
039–040	Catalog number index

Appendix

Technical information

Wiring duct — wire fill capacity

NOTE: Wire fill is based on 50% fill of duct area.

Nominal duct size (inches)	Area	Electrical											Data cable					
		8 AWG		10 AWG		12 AWG		14 AWG			16 AWG		18 AWG		22 AWG	24 AWG		
		0.216	0.153	0.122	0.158	0.105	0.139	0.165	0.096	0.125	0.084	0.113	0.065	0.217	0.25	0.422		
W	H (inches ²)	THHN	THHN	THHN	MTW	THHN	MTW	MTW	THHN	MTW	THHN	MTW	MTW	UTP/CM CAT5E	UTP/CM CAT6	UTP/CM		
0.75 x 1.00	0.750	5	9	14	9	19	11	8	23	14	30	17	51	5	3	1		
0.75 x 1.50	1.125	7	14	22	13	29	17	12	35	21	46	25	76	7	5	2		
0.75 x 2.00	1.500	9	18	29	17	39	22	16	47	27	61	34	101	9	7	2		
1.00 x 1.00	1.000	6	12	19	11	26	15	10	31	18	40	22	68	6	5	2		
1.00 x 1.50	1.500	9	18	29	17	39	22	16	47	27	61	34	101	9	7	2		
1.00 x 2.00	2.000	12	24	38	23	52	30	21	62	37	81	45	135	12	9	3		
1.00 x 3.00	3.000	18	37	58	34	78	44	31	93	55	121	67	203	18	14	5		
1.00 x 4.00	4.000	24	49	77	46	104	59	42	124	73	162	90	270	24	18	6		
1.50 x 1.00	1.500	9	18	29	17	39	22	16	47	27	61	34	101	9	7	2		
1.50 x 1.50	2.250	14	27	43	26	58	33	24	70	41	91	50	152	14	10	4		
1.50 x 2.00	3.000	18	37	58	34	78	44	31	93	55	121	67	203	18	14	5		
1.50 x 3.00	4.500	27	55	86	52	117	67	47	140	82	182	101	304	27	21	7		
1.50 x 4.00	6.000	36	73	115	69	155	89	63	186	110	243	134	406	36	27	10		
2.00 x 1.00	2.000	12	24	38	23	52	30	21	62	37	81	45	135	12	9	3		
2.00 x 1.50	3.000	18	37	58	34	78	44	31	93	55	121	67	203	18	14	5		
2.00 x 2.00	4.000	24	49	77	46	104	59	42	124	73	162	90	270	24	18	6		
2.00 x 3.00	6.000	36	73	115	69	155	89	63	186	110	243	134	406	36	27	10		
2.00 x 4.00	8.000	48	98	154	92	207	118	84	248	146	324	179	541	49	37	13		
2.00 x 5.00	10.000	60	122	192	114	259	148	105	310	183	405	224	676	61	46	16		
2.50 x 2.00	5.000	30	61	96	57	130	74	52	155	91	202	112	338	30	23	8		
2.50 x 3.00	7.500	45	92	144	86	194	111	79	233	137	304	168	507	46	34	12		
2.50 x 4.00	10.000	60	122	192	114	259	148	105	310	183	405	224	676	61	46	16		
3.00 x 1.00	3.000	18	37	58	34	78	44	31	93	55	121	67	203	18	14	5		
3.00 x 2.00	6.000	36	73	115	69	155	89	63	186	110	243	134	406	36	27	10		
3.00 x 3.00	9.000	54	110	173	103	233	133	94	279	165	364	201	609	55	41	14		
3.00 x 4.00	12.000	72	146	230	137	311	177	126	372	219	486	269	811	73	55	19		
3.00 x 5.00	15.000	90	183	288	172	389	222	157	465	274	607	336	1014	91	69	24		
4.00 x 1.50	6.000	36	73	115	69	155	89	63	186	110	243	134	406	36	27	10		
4.00 x 2.00	8.000	48	98	154	92	207	118	84	248	146	324	179	541	49	37	13		
4.00 x 3.00	12.000	72	146	230	137	311	177	126	372	219	486	269	811	73	55	19		
4.00 x 4.00	16.000	96	195	307	183	415	237	168	496	293	648	358	1082	97	73	26		
4.00 x 5.00	20.000	120	244	384	229	518	296	210	620	366	810	448	1352	121	91	32		
6.00 x 4.00	24.000	144	293	461	275	622	355	252	744	439	972	537	1623	146	110	39		

Formula for calculating fill capacity

$$\text{Number of wires} = \frac{\text{Duct W} \times \text{H}}{1.75 \times (\text{Wire O.D.})^2} \div 2$$

—
Properties of materials used in wiring duct

Property	Units	ASTM test	PVC	Halogen-free
Specific gravity	–	D792	1.43	1.10
IZOD	ft.-lb./in.	D256	2	5.0
Flexural strength	psi	D790	10,900	12,800
Flexural modulus	psi	D790	382,000	360,000
Tensile strength	psi	D638	5,500	7,800
Compressive strength	psi	D695	8,600	16,000
Water absorption	24 hrs.-%	D570	0.10	0.07
Hardness	Rockwell	D785	R-111	R-115
	Duro D	D676	78	–
Dielectric strength	–	D149	–	–
	60Hz, 25° C, s/t	vpm	–	400
Dielectric constant	–	D150	–	–
	60Hz, Dry	–	1.9	2.65
	1MHz, Dry	–	–	2.64
Volume resistivity	ohm-cm	D257	–	1017
Heat deflecting (° F@ 264 psi)	° F	D648	158	212
Flammability	–	–	94 V-0	94 V-1

Note: The user should check the applicable specifications to verify values.

Rigid polyvinyl chloride (PVC)

- General-purpose material for indoor applications
- UL flammability rating of V-0
- UL94 recognized for use in temperatures up to 60 °C (140 °F)
- Economical wiring duct material

Halogen-free

With 8-12 / 4-6mm slots

- Halogen-free thermoplastic in conformity with VDE 0472 standard Part 815: Br + Cl < 0.2 %, F < 0.1 %
- Toxic smoke index: 25.78 in conformity with NF X70-100 and NF F16-101 standards
- Opacity of smoke*:
 - Dm 352.2 (2 mm)
 - VOF4 475.8 (2 mm) in conformity with NF X10-702 standard (NF F16-101 reference)
- Based on the values obtained in the opacity and toxicity tests of smoke, the material belongs to class F2 (in conformity with NF F16-101 standard)
- Insulating, shock-resistant and self-extinguishing thermoplastic in conformity with UL94V-0 standard, resistant to abnormal heat and fire up to 850 °C (glow-wire test) in conformity with IEC 60695-2-1 standard
- Dimensional stability from -40 °C to 100 °C
- Standard length 2 meters
- Color RAL 7035 gray
- Conforms to EN 50085-2-3 standard
- Conforms to RoHS directive

* Reduced smoke opacity during the first 4 minutes of a fire facilitates evacuation from areas of risk.

Appendix

Dimensional information

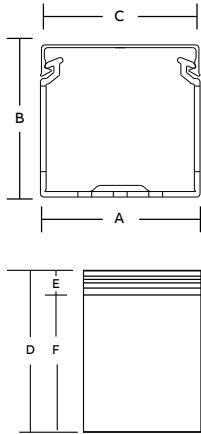

Solid wall PVC wiring duct dimensions

Trade size (in.)		Dimensions (in.)						
W		H	A	B	C	D	E	F
0.75	x	1.00	0.94	1.14	0.94	1.03	0.26	0.77
0.75	x	1.50	0.94	1.60	0.94	1.50	0.27	1.23
0.75	x	2.00	0.94	2.10	0.94	2.01	0.29	1.73
1.00	x	1.00	1.25	1.14	1.25	1.03	0.26	0.77
1.00	x	1.50	1.25	1.60	1.25	1.50	0.27	1.23
1.00	x	2.00	1.25	2.10	1.25	2.01	0.28	1.73
1.00	x	3.00	1.25	3.05	1.25	2.99	0.32	2.68
1.00	x	4.00	1.25	4.37	1.25	4.32	0.32	4.00
1.50	x	1.00	1.75	1.14	1.75	1.03	0.26	0.77
1.50	x	1.50	1.75	1.60	1.75	1.50	0.27	1.23
1.50	x	2.00	1.75	2.10	1.75	2.01	0.29	1.73
1.50	x	3.00	1.75	3.05	1.75	2.99	0.34	2.65
1.50	x	4.00	1.75	4.37	1.75	4.32	0.32	4.00
2.00	x	1.00	2.25	1.24	2.25	1.05	0.28	0.77
2.00	x	1.50	2.25	1.70	2.25	1.52	0.29	1.23
2.00	x	2.00	2.25	2.19	2.25	2.03	0.30	1.73
2.00	x	3.00	2.25	3.14	2.25	3.00	0.33	2.68
2.00	x	4.00	2.25	4.46	2.25	4.33	0.33	4.00
2.00	x	5.00	2.25	5.15	2.25	5.02	0.34	4.68
2.50	x	2.00	2.75	2.19	2.75	2.03	0.30	1.73
2.50	x	3.00	2.75	3.14	2.75	3.00	0.33	2.68
2.50	x	4.00	2.75	4.46	2.75	4.33	0.33	4.00
3.00	x	1.00	3.25	1.24	3.25	1.06	0.29	0.77
3.00	x	2.00	3.25	2.19	3.25	2.08	0.35	1.73
3.00	x	3.00	3.25	3.14	3.25	3.06	0.38	2.68
3.00	x	4.00	3.25	4.46	3.25	4.39	0.39	4.00
3.00	x	5.00	3.25	5.15	3.25	5.06	0.38	4.68
4.00	x	1.50	4.25	1.70	4.25	1.57	0.34	1.23
4.00	x	2.00	4.25	2.19	4.25	2.08	0.35	1.73
4.00	x	3.00	4.25	3.14	4.25	3.06	0.38	2.68
4.00	x	4.00	4.25	4.46	4.25	4.39	0.39	4.00
4.00	x	5.00	4.25	5.15	4.25	5.06	0.38	4.68
6.00	x	4.00	6.25	4.46	6.25	4.39	0.39	4.00

Dimensions shown are for reference only. For complete dimensional and mounting hole patterns, contact your local sales office.

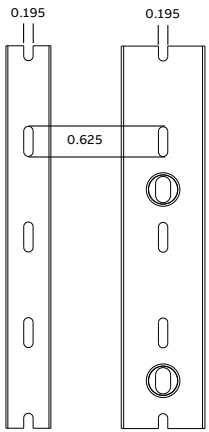

Pattern for 3/4" & 1" Pattern for 1 1/2"

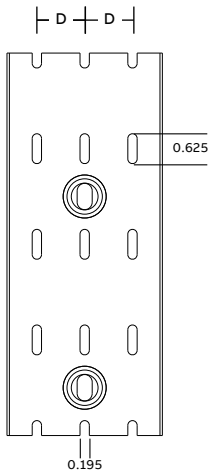

Pattern for 2", 2 1/2", 3", 4" & 6"

Duct width (in.)	D (in.)
2	0.50
2.5	0.75
3	1.00
4	1.50
6	2.50

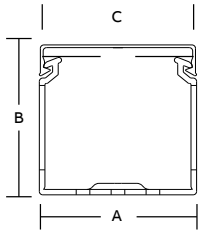

Wide slot PVC wiring duct dimensions

Trade size (in.)		Dimensions (in.)									
W		H	A	B	C	D	E	F	G	H	I
0.75	x	1.00	0.94	1.14	0.94	1.03	0.30	0.52	0.26	0.10	0.80
0.75	x	1.50	0.94	1.60	0.94	1.50	0.30	0.93	0.27	0.10	0.80
0.75	x	2.00	0.94	2.10	0.94	2.01	0.30	1.36	0.29	0.10	0.80
1.00	x	1.00	1.25	1.14	1.25	1.03	0.30	0.52	0.26	0.10	0.80
1.00	x	1.50	1.25	1.60	1.25	1.50	0.30	0.93	0.27	0.10	0.80
1.00	x	2.00	1.25	2.10	1.25	2.01	0.30	1.36	0.28	0.10	0.80
1.00	x	3.00	1.25	3.05	1.25	2.99	0.30	2.31	0.32	0.10	1.00
1.00	x	4.00	1.25	4.37	1.25	4.32	0.30	3.63	0.32	0.10	1.00
1.50	x	1.00	1.75	1.14	1.75	1.03	0.30	0.52	0.26	0.10	0.80
1.50	x	1.50	1.75	1.60	1.75	1.50	0.30	0.93	0.27	0.10	0.80
1.50	x	2.00	1.75	2.10	1.75	2.01	0.30	1.36	0.29	0.10	0.80
1.50	x	3.00	1.75	3.05	1.75	2.99	0.30	2.28	0.34	0.10	1.00
1.50	x	4.00	1.75	4.37	1.75	4.32	0.30	3.63	0.32	0.10	1.00
2.00	x	1.00	2.25	1.24	2.25	1.05	0.30	0.52	0.28	0.10	0.80
2.00	x	1.50	2.25	1.70	2.25	1.52	0.30	0.93	0.29	0.10	0.80
2.00	x	2.00	2.25	2.19	2.25	2.03	0.30	1.36	0.30	0.10	0.80
2.00	x	3.00	2.25	3.14	2.25	3.00	0.30	2.31	0.33	0.10	1.00
2.00	x	4.00	2.25	4.46	2.25	4.33	0.30	3.63	0.33	0.10	1.00
2.00	x	5.00	2.25	5.15	2.25	5.02	0.38	4.31	0.34	0.10	1.33
2.50	x	2.00	2.75	2.19	2.75	2.03	0.30	1.36	0.30	0.10	0.80
2.50	x	3.00	2.75	3.14	2.75	3.00	0.30	2.31	0.33	0.10	1.00
2.50	x	4.00	2.75	4.46	2.75	4.33	0.30	3.63	0.33	0.10	1.00
3.00	x	1.00	3.25	1.24	3.25	1.06	0.30	0.52	0.29	0.10	0.80
3.00	x	2.00	3.25	2.19	3.25	2.08	0.30	1.36	0.35	0.10	0.80
3.00	x	3.00	3.25	3.14	3.25	3.06	0.30	2.31	0.38	0.10	1.00
3.00	x	4.00	3.25	4.46	3.25	4.39	0.30	3.63	0.39	0.10	1.00
3.00	x	5.00	3.25	5.15	3.25	5.06	0.38	4.31	0.38	0.10	1.33
4.00	x	1.50	4.25	1.70	4.25	1.57	0.30	0.93	0.34	0.10	0.80
4.00	x	2.00	4.25	2.19	4.25	2.08	0.30	1.36	0.35	0.10	0.80
4.00	x	3.00	4.25	3.14	4.25	3.06	0.30	2.31	0.38	0.10	1.00
4.00	x	4.00	4.25	4.46	4.25	4.39	0.30	3.63	0.39	0.10	1.00
4.00	x	5.00	4.25	5.15	4.25	5.06	0.38	4.31	0.38	0.10	1.33
6.00	x	4.00	6.25	4.46	6.25	4.39	0.30	3.63	0.39	0.10	1.00

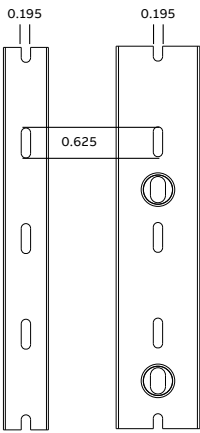
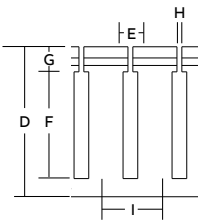

Pattern for 3/4" & 1"

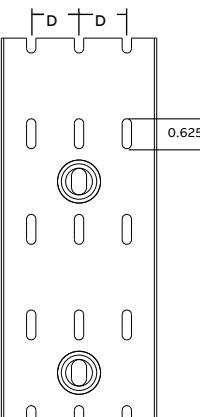

Pattern for 2", 2 1/2", 3", 4" & 6"

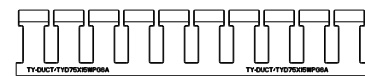

3/4" x 1 1/2"

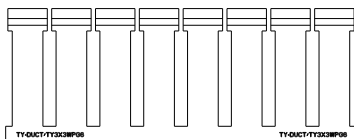

3" x 3"

Duct width (in.)	D (in.)
2	0.50
2.5	0.75
3	1.00
4	1.50
6	2.50

Dimensions shown are for reference only. For complete dimensional and mounting hole patterns, contact your local sales office.

Appendix

Dimensional information

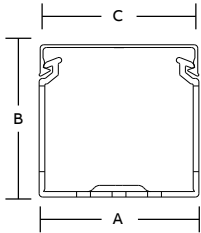

Narrow slot PVC wiring duct dimensions

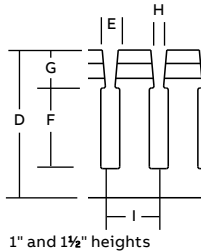

1" and 1 1/2" heights

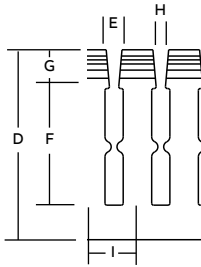

2" height

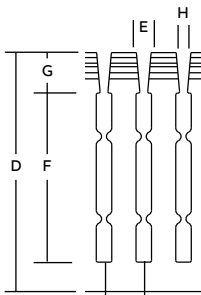

3", 4" and 5" heights

Trade size (in.)		Dimensions (in.)									
W		H	A	B	C	D	E	F	G	H	I
0.75	x	1.50	0.94	1.60	0.94	1.50	0.20	0.93	0.27	0.10	0.50
1.00	x	1.00	1.25	1.14	1.25	1.03	0.20	0.52	0.26	0.10	0.50
1.00	x	1.50	1.25	1.60	1.25	1.50	0.20	0.93	0.27	0.10	0.50
1.00	x	2.00	1.25	2.10	1.25	2.01	0.20	1.36	0.28	0.10	0.50
1.00	x	3.00	1.25	3.05	1.25	2.99	0.20	2.31	0.32	0.10	0.50
1.00	x	4.00	1.25	4.37	1.25	4.32	0.20	3.63	0.32	0.10	0.50
1.50	x	1.00	1.75	1.14	1.75	1.03	0.20	0.52	0.26	0.10	0.50
1.50	x	1.50	1.75	1.60	1.75	1.50	0.20	0.93	0.27	0.10	0.50
1.50	x	2.00	1.75	2.10	1.75	2.01	0.20	1.36	0.29	0.10	0.50
1.50	x	3.00	1.75	3.05	1.75	2.99	0.20	2.28	0.34	0.10	0.50
1.50	x	4.00	1.75	4.37	1.75	4.32	0.20	3.63	0.32	0.10	0.50
2.00	x	1.00	2.25	1.24	2.25	1.05	0.20	0.52	0.28	0.10	0.50
2.00	x	1.50	2.25	1.70	2.25	1.52	0.20	0.93	0.29	0.10	0.50
2.00	x	2.00	2.25	2.19	2.25	2.03	0.20	1.36	0.30	0.10	0.50
2.00	x	3.00	2.25	3.14	2.25	3.00	0.20	2.31	0.33	0.10	0.50
2.00	x	4.00	2.25	4.46	2.25	4.33	0.20	3.63	0.33	0.10	0.50
2.00	x	5.00	2.25	5.15	2.25	5.02	0.20	4.31	0.34	0.10	0.50
2.50	x	2.00	2.75	2.19	2.75	2.03	0.20	1.36	0.30	0.10	0.50
2.50	x	3.00	2.75	3.14	2.75	3.00	0.20	2.31	0.33	0.10	0.50
2.50	x	4.00	2.75	4.46	2.75	4.33	0.20	3.63	0.33	0.10	0.50
3.00	x	1.00	3.25	1.24	3.25	1.06	0.20	0.52	0.29	0.10	0.50
3.00	x	2.00	3.25	2.19	3.25	2.08	0.20	1.36	0.35	0.10	0.50
3.00	x	3.00	3.25	3.14	3.25	3.06	0.20	2.31	0.38	0.10	0.50
3.00	x	4.00	3.25	4.46	3.25	4.39	0.20	3.63	0.39	0.10	0.50
3.00	x	5.00	3.25	5.15	3.25	5.06	0.20	4.31	0.38	0.10	0.50
4.00	x	2.00	4.25	2.19	4.25	2.08	0.20	1.36	0.35	0.10	0.50
4.00	x	3.00	4.25	3.14	4.25	3.06	0.20	2.31	0.38	0.10	0.50
4.00	x	4.00	4.25	4.46	4.25	4.39	0.20	3.63	0.39	0.10	0.50
4.00	x	5.00	4.25	5.15	4.25	5.06	0.20	4.31	0.38	0.10	0.50

Dimensions shown are for reference only. For complete dimensional and mounting hole patterns, contact your local sales office.

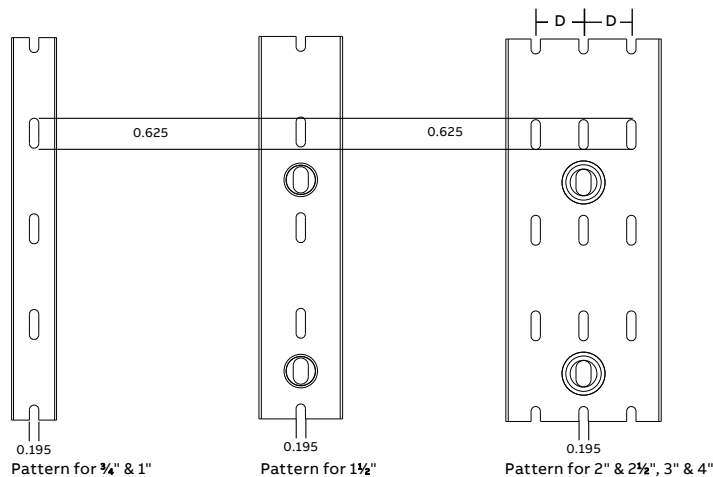

Duct width (in.)	D (in.)
2	0.50
2.5	0.75
3	1.00
4	1.50

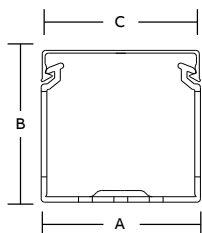

—
Round hole PVC wiring duct dimensions

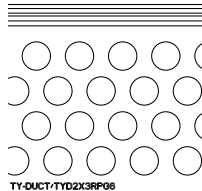
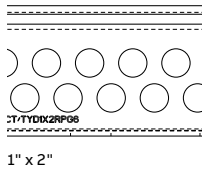
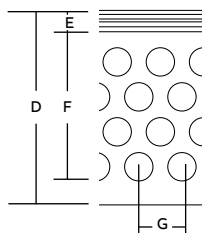

Trade size (in.)		Dimensions (in.)								Rows of holes
W		H	A	B	C	D	E	F	G	
1.00	x	1.50	1.25	1.60	1.25	1.50	0.27	1.23	0.67	2
1.00	x	2.00	1.25	2.10	1.25	2.01	0.28	1.73	0.67	2
1.00	x	3.00	1.25	3.05	1.25	2.99	0.32	2.68	0.67	4
1.00	x	4.00	1.25	4.37	1.25	4.32	0.32	4.00	0.67	6
1.50	x	1.00	1.75	1.14	1.75	1.03	0.26	0.77	0.67	2
1.50	x	1.50	1.75	1.60	1.75	1.50	0.27	1.23	0.67	2
1.50	x	2.00	1.75	2.10	1.75	2.01	0.29	1.73	0.67	2
1.50	x	3.00	1.75	3.05	1.75	2.99	0.34	2.65	0.67	4
1.50	x	4.00	1.75	4.37	1.75	4.32	0.32	4.00	0.67	6
2.00	x	1.50	2.25	1.70	2.25	1.52	0.29	1.23	0.67	2
2.00	x	2.00	2.25	2.19	2.25	2.03	0.30	1.73	0.67	2
2.00	x	3.00	2.25	3.14	2.25	3.00	0.33	2.68	0.67	4
2.00	x	4.00	2.25	4.46	2.25	4.33	0.33	4.00	0.67	6
3.00	x	2.00	3.25	2.19	3.25	2.08	0.35	1.73	0.67	2
3.00	x	3.00	3.25	3.14	3.25	3.06	0.38	2.68	0.67	4
3.00	x	4.00	3.25	4.46	3.25	4.39	0.39	4.00	0.67	6
4.00	x	1.50	4.25	1.70	4.25	1.57	0.34	1.23	0.67	2
4.00	x	2.00	4.25	2.19	4.25	2.08	0.35	1.73	0.67	2
4.00	x	3.00	4.25	3.14	4.25	3.06	0.38	2.68	0.67	4
4.00	x	4.00	4.25	4.46	4.25	4.39	0.39	4.00	0.67	6

Dimensions shown are for reference only. For complete dimensional and mounting hole patterns, contact your local sales office.

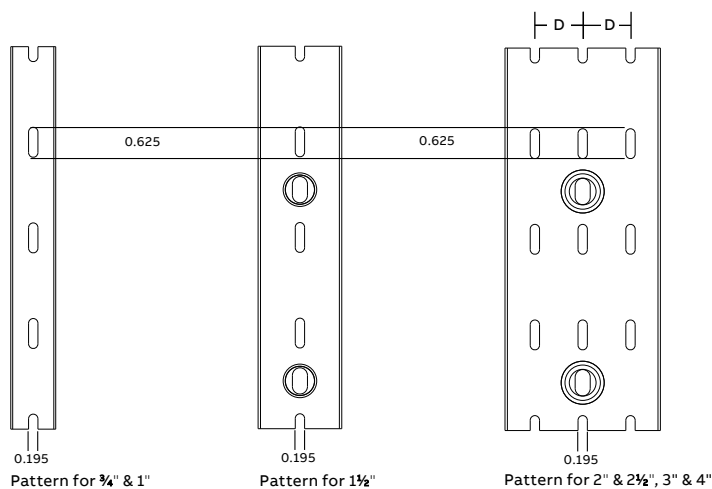

Duct width (in.)	D (in.)
2	0.50
2.5	0.75
3	1.00
4	1.50

Appendix

Dimensional information

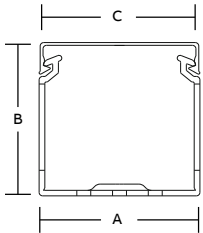

Wide slot halogen-free and metric wiring duct dimensions

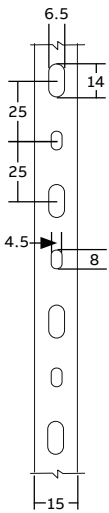
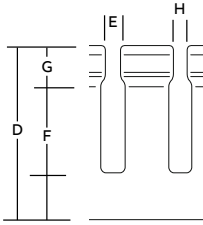

Trade size (mm)		Dimensions (mm)									
W		H	A	B	C	D	E	F	G	H	I
15	X	17	15	17	18.3	16.25	8	9.7	3.55	5.4	20
25	X	30	25	30	28.3	28.5	8	6.5	12	2	20
40	X	30	40	30	43.3	28.5	8	6.5	12	2	20
60	X	30	60	30	63.3	28.5	8	6.5	12	2	20
25	X	40	25	40	28.3	38.5	8	14.5	12	2	20
40	X	40	40	40	43.3	38.5	8	14.5	12	2	20
60	X	40	60	40	63.3	38.5	8	14.5	12	2	20
80	X	40	80	40	83.3	38.5	8	14.5	12	2	20
100	X	40	100	40	103.3	38.5	8	14.5	12	2	20
120	X	40	120	40	123.3	38.5	8	14.5	12	2	20
25	X	60	25	60	28.3	58.5	8	32.5	12	2	20
40	X	60	40	60	43.3	58.5	8	32.5	12	2	20
60	X	60	60	60	63.3	58.5	8	32.5	12	2	20
80	X	60	80	60	83.3	58.5	8	32.5	12	2	20
100	X	60	100	60	103.3	58.5	8	32.5	12	2	20
120	X	60	120	60	123.3	58.5	8	32.5	12	2	20
25	X	80	25	80	28.3	78	8	53	12	2	20
40	X	80	40	80	43.3	78	8	53	12	2	20
60	X	80	60	80	63.3	78	8	53	12	2	20
80	X	80	80	80	83.3	78	8	53	12	2	20
100	X	80	100	80	103.3	78	8	53	12	2	20
120	X	80	120	80	123.3	78	8	53	12	2	20
40	X	100	40	100	43.3	98	8	70	12	2	20
60	X	100	60	100	63.3	98	8	70	12	2	20
80	X	100	80	100	83.3	98	8	70	12	2	20
100	X	100	100	100	103.3	98	8	70	12	2	20

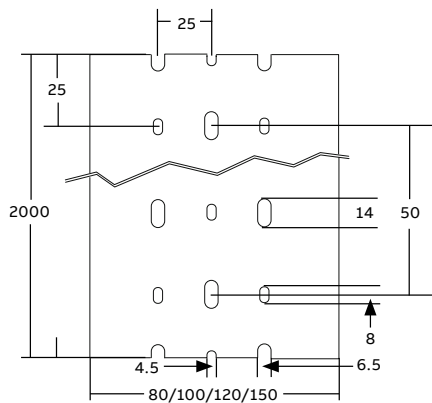
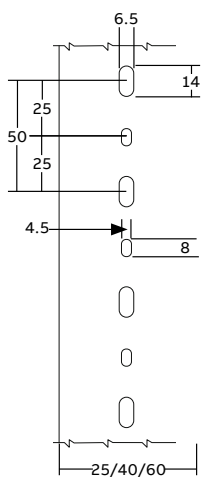

- A = duct width
- B = total height (duct + cover)
- C = overall cover width
- D = duct height
- E = slot width
- F = slot height
- G = cover engagement height
- H = insertion width
- I = slot to slot distance

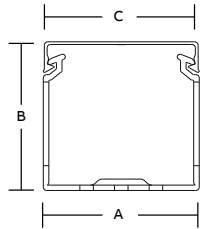

Narrow slot halogen-free and metric wiring duct dimensions

Trade size (mm)		Dimensions (mm)									
W		H	A	B	C	D	E	F	G	H	I
15	X	17	15	17	18.3	16.25	4	9.7	3.55	1.4	10
25	X	30	25	30	28.3	28.5	4	7.3	12	1.6	10
40	X	30	40	30	43.3	28.5	4	7.3	12	1.6	10
60	X	30	60	30	63.3	28.5	4	7.3	12	1.6	10
25	X	40	25	40	28.3	38.5	4	15.3	12	1.6	10
40	X	40	40	40	43.3	38.5	4	15.3	12	1.6	10
60	X	40	60	40	63.3	38.5	4	15.3	12	1.6	10
80	X	40	80	40	83.3	38.5	4	15.3	12	1.6	10
100	X	40	100	40	103.3	38.5	4	15.3	12	1.6	10
120	X	40	120	40	123.3	38.5	4	15.3	12	1.6	10
25	X	60	25	60	28.3	58.5	4	32.5	12	1.6	10
40	X	60	40	60	43.3	58.5	4	32.5	12	1.6	10
60	X	60	60	60	63.3	58.5	4	32.5	12	1.6	10
80	X	60	80	60	83.3	58.5	4	32.5	12	1.6	10
100	X	60	100	60	103.3	58.5	4	32.5	12	1.6	10
120	X	60	120	60	123.3	58.5	4	32.5	12	1.6	10
25	X	80	25	80	28.3	78	4	53	12	1.6	10
40	X	80	40	80	43.3	78	4	53	12	1.6	10
60	X	80	60	80	63.3	78	4	53	12	1.6	10
80	X	80	80	80	83.3	78	4	53	12	1.6	10
100	X	80	100	80	103.3	78	4	53	12	1.6	10
120	X	80	120	80	123.3	78	4	53	12	1.6	10

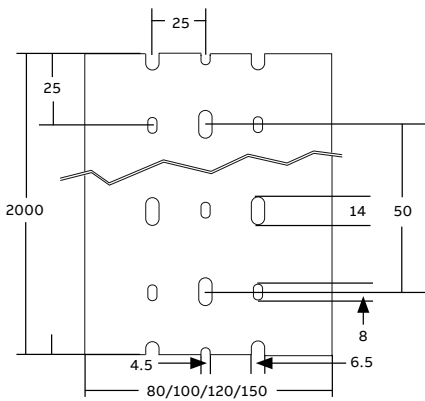
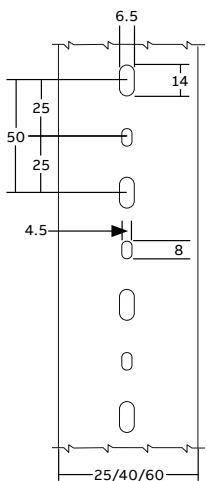
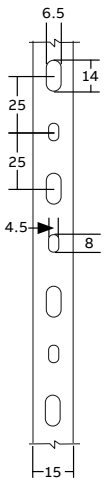
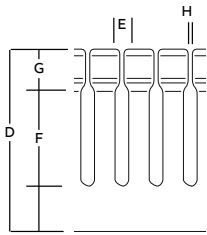

Appendix

Industry standards and certifications

Ty-Duct wiring duct meets all of the prominent agency approvals and standards.

Agency approvals:



Ty-Duct wiring duct is UL recognized for all requirements set forth in UL standard 1565 "Positioning Device."



The Ty-Duct wiring duct meets all applicable requirements of the Canadian Standard Association as described in CSA C22.2 No. 18.5.



All Ty-Duct wiring duct components comply with the European Directives for CE (Conformite European) Marking.

All materials used in the making of the Ty-Duct wiring duct comply with the European Directives 2002/95/EC (RoHS), 2002/96/EC (WEEE), and 2003/11/EC.

Metric duct certifications

- CSA certified file no. 077988
- RoHS compliant
- Conforms to EN50085-2-3 standard
- DIN standard

Standards:

UL 508/UL 508A

As required in UL508/UL508A a factory-installed conductor shall be separated from a conductor used in a different circuit when the conductors are not insulated for the maximum voltage of either circuit. The Ty-Duct wiring duct with a divider wall creates the required separation to meet this requirement.

DIN 43 659 (metric only)

This European standard specifies dimensions for slotted trunkings (metric only) installed in electrical switchgear assemblies. The standard defines the following dimensions:

- The mounting hole pattern
- The mounting hole slot dimensions
- The mounting hole pitch and location
- The minimum overall product length

Appendix

Catalog number index

Part. No.	Page	Part. No.	Page	Part. No.	Page
05019	19	05187	20	1SL9089A00	22
05033	19	05189	20	1SL9091A00	22
05035	19	05191	20	1SL9093A00	22
05037	19	05193	20	1SL9095A00	22
05043	19	05194	20	1SL9096A00	22
05045	19	05195	20	1SL9097A00	22
05047	19	05196	20	1SL9098A00	22
05049	19	05197	20	1SL9119A00	23
05051	19	05198	20	1SL9133A00	23
05053	19	05199	20	1SL9135A00	23
05063	19	05300	19–20	1SL9137A00	23
05065	19	05302	19–20	1SL9143A00	23
05067	19	05304	19–20	1SL9145A00	23
05069	19	05306	19–20	1SL9147A00	23
05071	19	05308	19–20	1SL9149A00	23
05073	19	05310	19–20	1SL9151A00	23
05083	19	05312	19–20	1SL9153A00	23
05085	19	05314	19–20	1SL9163A00	23
05087	19	08200C	25	1SL9165A00	23
05089	19	08205	28	1SL9167A00	23
05091	19	1SL5316A00	22-23	1SL9169A00	23
05093	19	1SL5317A00	22-23	1SL9171A00	23
05094	19	1SL5318A00	22-23	1SL9173A00	23
05095	19	1SL5319A00	22-23	1SL9183A00	23
05096	19	1SL5320A00	22-23	1SL9185A00	23
05097	19	1SL5321A00	22-23	1SL9187A00	23
05098	19	1SL5322A00	22-23	1SL9189A00	23
05099	19	1SL9019A00	22	1SL9191A00	23
05119	20	1SL9033A00	22	1SL9193A00	23
05133	20	1SL9035A00	22	CC125	27
05135	20	1SL9037A00	22	DC-125TB	26
05137	20	1SL9043A00	22	DK-65TB	27
05143	20	1SL9045A00	22	DNT-100TB	28
05145	20	1SL9047A00	22	SX-25TB	27
05147	20	1SL9049A00	22	TY1.5D[_] [_] 6	24
05149	20	1SL9051A00	22	TY15MC	26
05151	20	1SL9053A00	22	TY1D[_] [_] 6	24
05153	20	1SL9063A00	22	TY1MC	24
05163	20	1SL9065A00	22	TY2D[_] [_] 6	24
05165	20	1SL9067A00	22	TY2MC	24
05167	20	1SL9069A00	22	TY3D[_] [_] 6	24
05169	20	1SL9071A00	22	TY3MC	26
05171	20	1SL9073A00	22	TY4D[_] [_] 6	24
05173	20	1SL9083A00	22	TY5D[_] [_] 6	24
05183	20	1SL9085A00	22	TYCS[_] 6	25
05185	20	1SL9087A00	22	TYD15CP[_] 6	11, 13, 15, 17

Appendix

Catalog number index

Part. No.	Page	Part. No.	Page	Part. No.	Page
TYD15X15NP[_]6	15	TYD25X4NP[_]6	15	TYD4X15RP[_]6	17
TYD15X15RP[_]6	17	TYD25X4SP[_]6	11	TYD4X15SP[_]6	11
TYD15X15SP[_]6	11	TYD25X4WP[_]6	13	TYD4X15WP[_]6	13
TYD15X15WP[_]6	13	TYD2CP[_]6	11, 13, 15, 17	TYD4X2NP[_]6	15
TYD15X1NP[_]6	15	TYD2X15NP[_]6	15	TYD4X2RP[_]6	17
TYD15X1SP[_]6	11	TYD2X15RP[_]6	17	TYD4X2SP[_]6	11
TYD15X1WP[_]6	13	TYD2X15SP[_]6	11	TYD4X2WP[_]6	13
TYD15X2NP[_]6	15	TYD2X15WP[_]6	13	TYD4X3NP[_]6	15
TYD15X2RP[_]6	17	TYD2X1NP[_]6	15	TYD4X3RP[_]6	17
TYD15X2SP[_]6	11	TYD2X1SP[_]6	11	TYD4X3SP[_]6	11
TYD15X2WP[_]6	13	TYD2X1WP[_]6	13	TYD4X3WP[_]6	13
TYD15X3NP[_]6	15	TYD2X2NP[_]6	15	TYD4X4NP[_]6	15
TYD15X3RP[_]6	17	TYD2X2RP[_]6	17	TYD4X4RP[_]6	17
TYD15X3SP[_]6	11	TYD2X2SP[_]6	11	TYD4X4SP[_]6	11
TYD15X3WP[_]6	13	TYD2X2WP[_]6	13	TYD4X4WP[_]6	13
TYD15X4NP[_]6	15	TYD2X3NP[_]6	15	TYD4X5NP[_]6	15
TYD15X4RP[_]6	17	TYD2X3RP[_]6	17	TYD4X5SP[_]6	11
TYD15X4SP[_]6	11	TYD2X3SP[_]6	11	TYD4X5WP[_]6	13
TYD15X4WP[_]6	13	TYD2X3WP[_]6	13	TYD6CP[_]6	11, 13
TYD1CP[_]6	11, 13, 15, 17	TYD2X4NP[_]6	15	TYD6X4SP[_]6	11
TYD1X15NP[_]6	15	TYD2X4RP[_]6	17	TYD6X4WP[_]6	13
TYD1X15RP[_]6	17	TYD2X4SP[_]6	11	TYD75CP[_]6	11, 13, 15
TYD1X15SP[_]6	11	TYD2X4WP[_]6	13	TYD75X15NP[_]6	15
TYD1X15WP[_]6	13	TYD2X5NP[_]6	15	TYD75X15SP[_]6	11
TYD1X1NP[_]6	15	TYD2X5SP[_]6	11	TYD75X15WP[_]6	13
TYD1X1SP[_]6	11	TYD2X5WP[_]6	13	TYD75X1SP[_]6	11
TYD1X1WP[_]6	13	TYD3CP[_]6	11, 13, 15, 17	TYD75X1WP[_]6	13
TYD1X2NP[_]6	15	TYD3X1NP[_]6	15	TYD75X2SP[_]6	11
TYD1X2RP[_]6	17	TYD3X1SP[_]6	11	TYD75X2WP[_]6	13
TYD1X2SP[_]6	11	TYD3X1WP[_]6	13	TYJC[_]6	25
TYD1X2WP[_]6	13	TYD3X2NP[_]6	15	TYWRC	26
TYD1X3NP[_]6	15	TYD3X2RP[_]6	17	TYWRG	26
TYD1X3RP[_]6	17	TYD3X2SP[_]6	11	UMC	24
TYD1X3SP[_]6	11	TYD3X2WP[_]6	13		
TYD1X3WP[_]6	13	TYD3X3NP[_]6	15		
TYD1X4NP[_]6	15	TYD3X3RP[_]6	17		
TYD1X4RP[_]6	17	TYD3X3SP[_]6	11		
TYD1X4SP[_]6	11	TYD3X3WP[_]6	13		
TYD1X4WP[_]6	13	TYD3X4NP[_]6	15		
TYD25CP[_]6	11, 13, 15	TYD3X4RP[_]6	17		
TYD25X2NP[_]6	15	TYD3X4SP[_]6	11		
TYD25X2SP[_]6	11	TYD3X4WP[_]6	13		
TYD25X2WP[_]6	13	TYD3X5NP[_]6	15		
TYD25X3NP[_]6	15	TYD3X5SP[_]6	11		
TYD25X3SP[_]6	11	TYD3X5WP[_]6	13		
TYD25X3WP[_]6	13	TYD4CP[_]6	11, 13, 15, 17		

